

# PERKO®

## CATALOG NO. 295 2003 - 2004

16490 Northwest 13th Avenue  
Miami, Florida 33169 - 5707

Mailing Address:

P.O. Box 64000D

Miami, Florida 33164 - 0510

Telephone Number: (305) 621-7525

Fax Number: (305) 620-9978

WWW.PERKO.COM

© Perko, Inc. 2002

All Rights Reserved

Portions of this Catalog Previously  
Copyrighted in 1936 - 2001

*Shaping the Wave of Excellence®*



MANUFACTURER OF SHIP AND BOAT EQUIPMENT

*Navigation Lights for  
Vessels Under 20 Meters  
1 to 47*

*Navigation Lights for  
Vessels Over 20 Meters  
48 to 60*

*Searchlights  
61 to 82*

*Lighting Fixtures, Bulbs  
and Battery Switches  
83 to 97*

*Compartment  
Ventilators and Bells  
98 to 103*

*Underwater Hdwe, Deck  
Plates, Fills and Vents  
104 to 130*

*Deck Hardware  
131 to 156*

*Cabinet Hardware  
157 to 192*

*Fishing Equipment  
193 to 202*



# GENERAL INFORMATION

## **SALES POLICY**

PERKO Products are sold through our established Distributors. We do not sell direct to the public or organizations. Therefore, possession of this catalog does not infer an offer to sell. Please contact your local marine supplier.

## **PRICES AND TERMS**

Our costs are subject to change due to causes beyond our control. Therefore, our price list is only intended for the guidance of our customers and does not necessarily establish current prices. *A Repackaging Service Charge of \$10.00 net will apply to all broken packages.* All prices are subject to change without notice. Terms are 1% 10 days, net 30 days.

Orders from firms having no satisfactory history or credit rating with us must be prepaid. C.O.D. shipments will be made if a 25% deposit is sent with order. Cash discounts do not apply to C.O.D. shipments.

## **PERKO®**

### **LIMITED WARRANTY**

PERKO, INC. (PERKO) warrants to the original consumer-purchaser that PERKO'S products will be free from defective materials or workmanship, and that the PERKOPLATE/PERKO•KOTE Finish will remain corrosion-free under normal use and service, for a period as shown below from the original purchase date:

Products installed by a manufacturer as original equipment	1 year or duration of the manufacturer's general accessory warranty, whichever is longer
Commercial Products (and/or Products used in Commercial Service) and Searchlights	1 Year
Products not included above and which are purchased over-the-counter at a retail dealer	5 Years

**ALL IMPLIED WARRANTIES, INCLUDING MERCHANTABILITY, ARE ALSO LIMITED IN DURATION TO THE WARRANTY PERIOD FROM THE ORIGINAL PURCHASE DATE.**

**PERKO SHALL NOT BE LIABLE FOR LOSS OF USE OF ANY OF ITS PRODUCTS, NOR FOR OTHER INCIDENTAL OR CONSEQUENTIAL COSTS, EXPENSES, OR DAMAGES INCURRED BY THE ORIGINAL PURCHASER OR BY ANY OTHER PERSON.**

**SOME STATES DO NOT ALLOW LIMITATIONS ON HOW LONG AN IMPLIED WARRANTY LASTS, SO THE ABOVE LIMITATION MAY OR MAY NOT APPLY TO YOU. SOME STATES DO NOT ALLOW THE EXCLUSION OR LIMITATION OF INCIDENTAL OR CONSEQUENTIAL DAMAGES, SO THE ABOVE LIMITATION OR EXCLUSION MAY OR MAY NOT APPLY TO YOU.**

This warranty is void if the product warranted has been damaged by accident or unreasonable use, neglect, improper service or other cause not arising out of defects in material or workmanship. Excluded from this warranty are Electric Light Bulbs (lamps), Sealed Beam Units and Fuses.

During the warranty period, your PERKO product will either be repaired or it will be replaced with a like product (at PERKO's option) without charge to the original consumer-purchaser, when returned prepaid and insured, with proof-of-purchase date to PERKO at our Factory in Miami, FL. In the event of replacement, the replacement product will continue the warranty of the original product, or ninety (90) days, whichever is longer. **Important: For this Warranty to be effective PERKO must be supplied with Proof-Of-Purchase date of the product.**

PERKO does not authorize any person or company to create for it any other obligation or liability in connection with any of its products.

## **DESIGNS**

For the purpose of constant improvement in our products, the designs and specifications are subject to change without notice.

## **RETURN GOODS**

Products made to order are not returnable. Stock products in new, saleable condition are only returnable when permission has been granted by us, and are subject to handling and repackaging charges. Return shipping charges must be prepaid. Purchase date and invoice number are required when requesting an R.G.A. (Return Goods Authorization) number. Permission must be requested within 30 days after receipt of goods.

## **WEIGHTS**

The weights given in this catalog are approximate, but should be sufficient for general purposes.

## **SHIPPING INSTRUCTIONS**

Customers should send specific shipping instructions; otherwise, we will use our own judgement in selecting route.

## **SHIPMENTS**

**E.O.B. our plant, Miami, Florida,** unless quoted otherwise. We are not responsible for damage, loss or delay after goods are delivered to carrier. When loss or delay occurs, we will gladly assist in tracing or expediting, but such assistance is no criterion of responsibility.

When there is **loss or apparent visible damage** to a shipment, when tendered for delivery, **do not** give the carrier a clear receipt. Note such damage on the carrier's delivery receipt and **have the driver sign the receipt.**

## **CONCEALED DAMAGE OR LOSS**

1. Advise the delivering carrier in writing as soon as discovered or at least no more than 15 days after delivery, and request carrier to make an inspection.
2. **Retain** for the carrier's inspection, the **container** and **all packaging** that the damaged or lost material was packaged in.
3. **Shortages** - Must be reported to us within 15 days after receipt of goods.

# ***Our Modern Self-Contained Facility***

***425,000 Sq. Ft. Home of PERKO, Inc.  
Located on 16 Acres in Miami, Florida***



***Computerized  
Tool & Die Dept.***

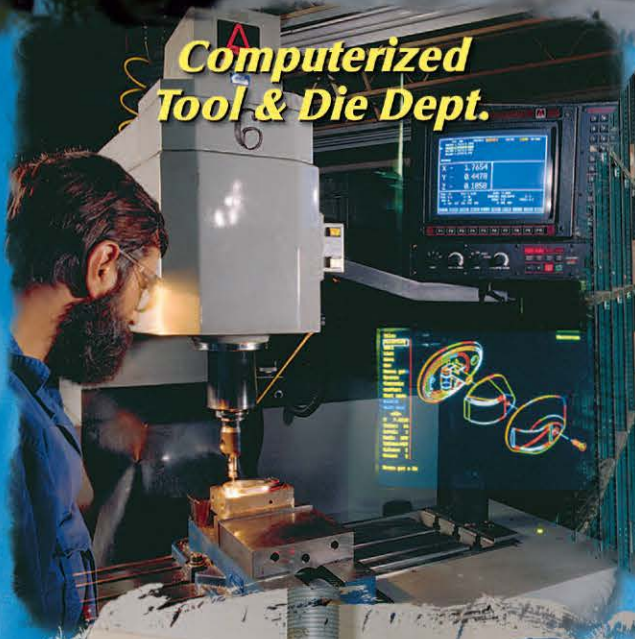

***Finished Goods  
Inventory***



***Quality Control Lab  
Atomic Absorption Spectrophotometry***



# ***Our Modern, Self-Contained, Vertically***

***Die Cast Department***

***State-of-the-Art  
Sand Cast Foundry***

***Searchlight  
Department***

***CNC Drilling And  
Tapping Centers***

***Mechanical Power Press  
Department***

# ***Integrated Manufacturing Facility***

***Plastic Injection Molding  
Department***



***Battery Switch Assembly  
Department***

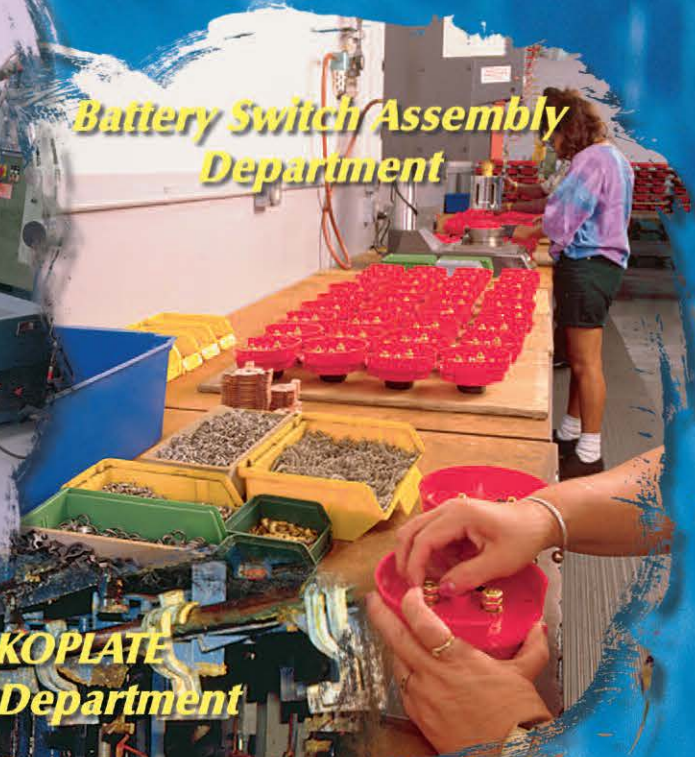

***PERKOPLATE  
Plating Department***

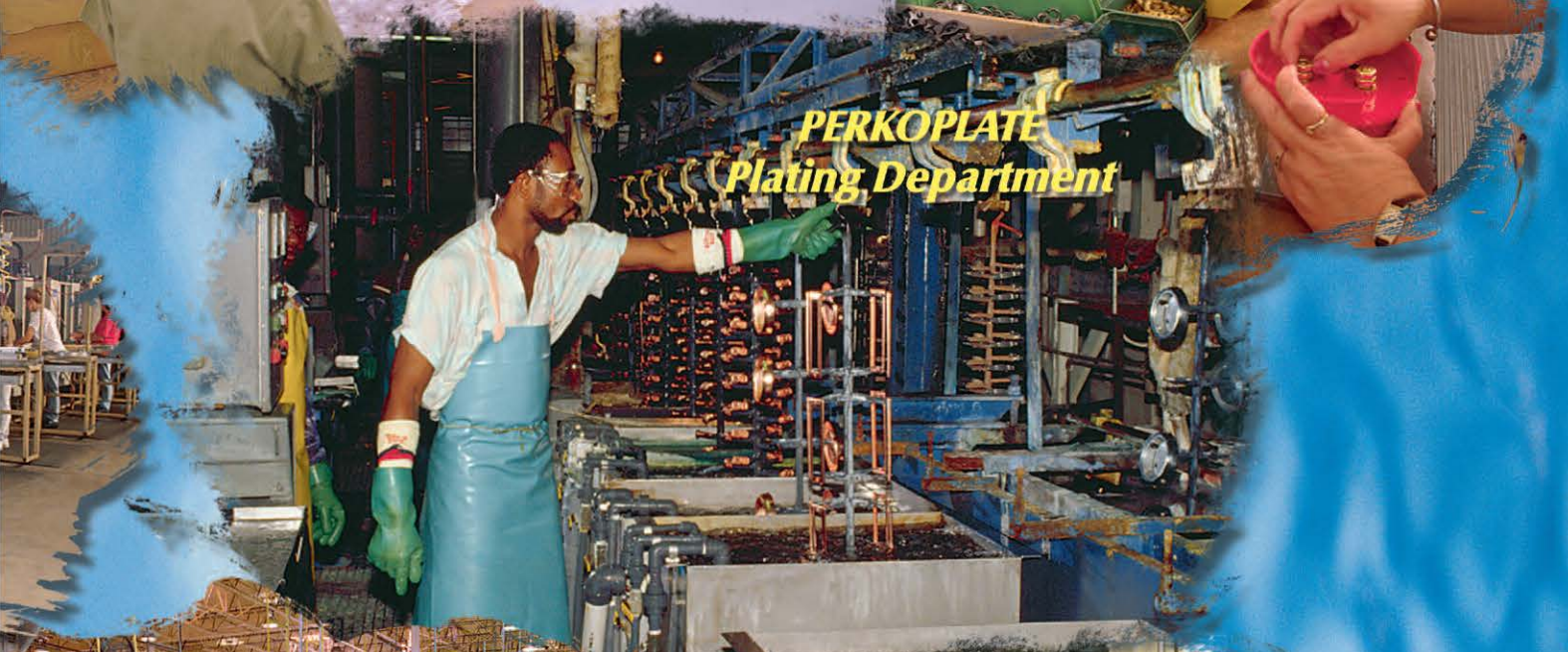

***Ultrasonic Bonding of  
Navigation Light Lenses***



***CNC Machining Center***

# REGIONAL SALES REPRESENTATIVES

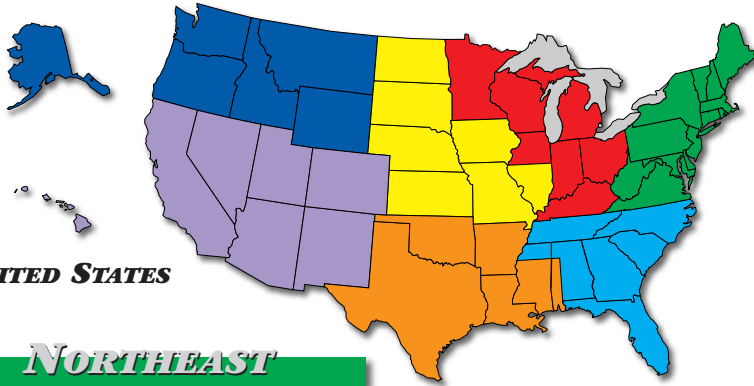

UNITED STATES

## NORTHEAST

**NEW HAMPSHIRE, VERMONT, NEW YORK, CONNECTICUT & COASTAL MAINE**  
CGW Associates  
P.O. Box 414  
Scituate, MA 02066  
Phone: 781-545-3790/Fax: 781-545-0359  
E-Mail: CGWCO@aol.com  
**CHARLES W. O'CONNOR**

**NEW JERSEY, LONG ISLAND, NEW YORK, SO. MASS., RHODE ISLAND**  
CGW Associates  
137 Brandt Island Road  
Mattapoisett, MA 02739  
Phone: 508-758-2980/Fax: 508-758-9705  
E-Mail: CGWVO@aol.com  
**WAYNE OLIVIERA**

**DELAWARE, PENNSYLVANIA, MARYLAND, VIRGINIA**  
CGW Associates  
1070 Ulmstead Circle, Arnold, MD 21012  
Phone: 410-757-9630/Fax: 410-757-4365  
E-Mail: KWCGW@aol.com  
**KEVIN WILLIAMS**

**CENT. MAINE, NO. MASS, PRINCE EDWARD ISLAND, NEWFOUNDLAND, NOVA SCOTIA & NEW BRUNSWICK**  
CGW Associates  
4 King Street Ct., Rockport, MA. 01966  
Phone: 978-546-2085/Fax: 978-546-5820  
E-Mail: CGWJH@aol.com  
**JACK HOGAN**

**ONTARIO, MANITOBA & QUEBEC CANADA**  
CGW Associates  
42 Oakridge Rd, Barrie, ON Canada L4N5N8  
Phone: 705-728-8151/Fax: 705-728-4327  
E-Mail: dalford1@home.com  
**DAVE ALFORD**

## SOUTHEAST

**NORTH CAROLINA**  
The Gartner Group  
3313 Highway 70 East, New Bern, NC 28560  
Phone: 252-633-1210/Fax: 252-633-1692  
E-Mail: ken@thegartnergroup.com  
E-Mail: leifr@thegartnergroup.com  
**KEN WILLIAMS & LEIF ERIKSSON**  
301 Clifton St., Summerville, S.C. 29483  
Phone/Fax: 843-875-3271/Cell: 843-708-0803  
E-Mail: gordon@thegartnergroup.com  
**GORDON PETERS, JR.**

**SOUTH CAROLINA & GEORGIA**  
The Gartner Group  
1313 Woodpecker Lane  
Hanahan, SC 29406  
Phone: 843-797-3073/Fax: 843-764-3511  
E-Mail: johnny@thegartnergroup.com  
**JOHNNY THOMERSON**

**TENNESSEE, MOST OF ALABAMA & NO. MISSISSIPPI**  
The Gartner Group  
Mac-Hugh & Associates  
9411 Raven Hollow Rd, Brentwood, TN 37027  
Phone: 615-370-4132/Fax: 615-373-3867  
E-Mail: bob@thegartnergroup.com  
**ROBERT TAYLOR**

**WESTERN & CENTRAL FLORIDA**  
The Gartner Group  
3345 Park Grove Ct., Longwood, FL 32779  
Phone: 407-333-1407/Fax: 407-805-9305  
E-Mail: tripp@thegartnergroup.com  
**TRIPP HAMMACK**

**EASTERN & SOUTHERN FLORIDA**  
The Gartner Group  
2470 N.E. 22 Street/ P.O. Box 50227  
Pompano Beach, FL 33062  
Phone: 954-781-4303/Fax: 954-781-4412  
E-Mail: jay@thegartnergroup.com  
**JAY BARNES**

## MIDWEST 1

**MISSOURI, IOWA, NO. & SO. DAKOTA & NEBRASKA**  
Midwestern Sales Co., Inc.  
9849 Briar Drive, Overland Park, KS 66207  
Phone: 913-649-1270/Fax: 913-648-2885  
E-Mail: MWS2000@swbell.net  
**DENNIS WILLS**

**KANSAS, SO. ILLINOIS & SO. MISSOURI**  
Midwestern Sales Co., Inc.  
17499 Ostrich Drive, Lebanon, MO 65536  
Phone/Fax: 417-533-5001  
E-Mail: tsapkoms@webund.com  
**TERRY SAPKO**

## MIDWEST 2

**MINNESOTA & WISCONSIN**  
Inland Marketing Associates, Inc.  
570 West 78th St., P.O. Box 2001  
Chanhassen, MN 55317  
Phone: 952-937-2304/Fax: 952-937-2353  
E-Mail: ted@imarep.com  
**TED LAMSON**

**ILLINOIS, INDIANA & KENTUCKY**  
Inland Marketing Associates, Inc.  
1071 Highland Ct./P.O. Box 414  
Plymouth, IN 46563  
Phone: 574-936-6972/Fax: 574-936-8248  
E-Mail: eddiek@imarep.com  
**ED KUYKENDALL**

**MICHIGAN, OHIO**  
Inland Marketing Associates, Inc.  
500 S. Washington/Suite 1  
Royal Oak, MI 48067  
Phone: 248-541-4404/Fax: 248-541-4405  
E-Mail: bill@imarep.com  
**R. WILLIAM BURT**

## SOUTH CENTRAL

**SO. CENTRAL TEXAS, OKLAHOMA, ARKANSAS**  
MAC-HUGH & Associates, Inc.  
7409 Hwy 349, Kilgore, TX 75662  
Phone: 504-734-9411/Fax: 504-734-5144  
**HUGH W. MULHOLLAND**

**LOUISIANA, WESTERN ALABAMA, SO. MISSISSIPPI, SO. EAST ARKANSAS,**  
MAC-HUGH & Associates, Inc.  
5540A Pepsi Street, Harahan, LA 70123  
Phone: 504-734-9411/Fax: 504-734-5144  
**KYLE McHUGH, BUZZ HUMPHREY, DAVID HILDRETH, GARRETT MCHUGH & KYLE MICHAEL MCHUGH, JR.**

## WEST

**CALIFORNIA, NEVADA, UTAH, COLORADO, ARIZONA, NEW MEXICO HAWAII,**  
Pacific Marine Marketing, Inc.  
3368 McGraw Lane, Lafayette, CA 94549  
Phone: 925-284-4855/Fax: 925-284-4856  
E-Mail: w.moosers@att.net  
**WAYNE R. MOOERS**

## NORTHWEST

**WASHINGTON, ALBERTA, BRITISH COLUMBIA, ALASKA, OREGON, IDAHO, MONTANA, WYOMING**  
West-Line Marine Sales Co.  
Mail: P.O. Box 1564, Lake Oswego, 97035  
Shipping: 16598 72nd Ave., Portland, OR 97224  
Phone: 503-639-5275/Fax: 503-684-6399  
E-Mail: westline@gte.net  
**BILL PASCHALL**

West-Line Marine Sales Co.  
P.O. Box 3369, Redmond, WA 98073  
Phone: 425-883-4115/Fax: 425-885-1695  
E-Mail: jawede@msn.com  
**JOHN WEDEBERG**

West-Line Marine Sales Co.  
P.O. Box 481, Anacortes, WA 98221  
Phone: 360-293-5563/Fax: 360-293-6657  
**BILL RYAN**

West-Line Marine Sales Co.  
2120 Ave. H, White City, OR 97503  
Phone: 541-826-3927/Fax: 541-826-5799  
E-Mail: chambers@medford.net  
**CHUCK CHAMBERS**

**COMMERCIAL PRODUCTS**  
B.A. Griffin Associates, Inc.  
355 Grow Ave. N.W.  
Bainbridge Island, WA 98110  
Phone: 206-780-0509/Fax: 206-855-9080  
E-Mail: bagriffin@earthlink.net  
**BARRY GRIFFIN**

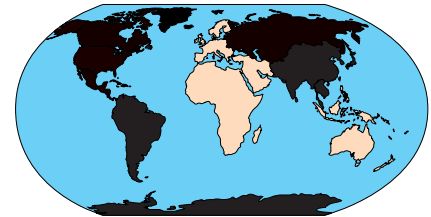

## INTERNATIONAL

**EUROPE, SO. EAST ASIA, AFRICA, MIDDLE EAST & AUSTRALIA**  
Greenwich Trading Co.  
**Head Office**  
256 Post Rd. East, Suite 205  
Westport, CT 06880  
Phone: 203-226-9697/Fax: 203-226-9935  
E-Mail: sales@greenwichtrade.com  
**DANIEL J. LYONS**

Greenwich Trading Co.  
**European Office**  
Linnicher Strasse 33, D-52428  
Jülich, Germany, Phone: 49.2461.346915  
Fax: 49.2461.346924  
E-Mail: uwittfeld@greenwichtrade.com  
**ULRICH WITTFELD, DIPL-ING**

Greenwich Trading Co.  
**Middle East Office**  
P.O. Box 61286 Jebel Ali Free Zone  
Dubai, U.A.E.  
Phone: 971.4.8813.167/Fax: 971.4.8813.168  
E-Mail: hyusuf@greenwichtrade.com  
**HAKIM M. YUSUF**

Greenwich Trading Co.  
**Miami Office**  
7812 N.W. 54th St.  
Miami, FL 33166  
Phone: 305-593-5535/Fax: 305-593-5529  
E-Mail: osocarras@greenwichtrade.com  
**OSCAR SOCARRAS**

**For Information on all Export & Foreign Regions Contact:**  
**Jose Martinez at Perko, Inc.**

# DEALER PACKAGE PROGRAM

**OUR ONGOING PROGRAM OF SERVICE AND SUPPORT BACKS OUR COMMITMENT TO INCREASED DEALER/DISTRIBUTOR SALES AND PROFITS. IT'S A PERKO PLUS!**

**SINCE THE PUBLICATION OF OUR LAST CATALOG WE HAVE BEGUN THE PROCESS OF SWITCHING AS MANY PRODUCTS AS POSSIBLE FROM BLISTER CARDS TO CLAMSHELLS. THESE ATTRACTIVE NEW PACKAGES PROTECT THE PRODUCTS BETTER THAN BLISTERS AND ARE EASIER TO RECYCLE. AND SINCE THEY ARE SMALLER, MORE PRODUCTS CAN BE DISPLAYED IN THE SAME AMOUNT OF SPACE.**

**AS YOU LOOK THROUGH THIS CATALOG YOU WILL SEE THE "DP" SYMBOL (SHOWN BELOW) THAT REPRESENTS OUR "DEALER PACKAGE" ITEMS. SEVERAL OF OUR DEALER PACK STYLES ARE REPRESENTED IN THE PICTURE BELOW.**



**BLISTER PACK**

**SKIN PACK**

**CLAM SHELL**

# UNDERSTANDING NAVIGATION LIGHT CERTIFICATIONS

All U.S. registered vessels are subject to either the '72 COLREGS or the U.S. inland rules. Effective 11/1/03 this will mean that lights must meet one of 3 types of certification depending on the size of the vessel and the date when it was manufactured.

## LARGE BOATS OVER 20 METERS (65.6 FT.)

The U.S. Coast Guard is accepting lights that have passed the U.L. tests (U.L. Standard 1104) as meeting the '72 COLREGS and the U.S. Inland Rules for vessels over 20 meters (65.6 ft.). As the first domestic manufacturer to pass U.L. 1104, PERKO's lights can be installed on vessels over 20 meters (65.6 ft.). PERKO manufactures two sizes of lights for the large boat market. The first group of lights is for vessels between 20 meters and 50 meters. The second group includes larger lights and is for vessels over 20 meters (without an upper limit on length).

A brass tag is permanently affixed to the light indicating the type of light, catalog number, voltage and bulb types to install to meet the visibility requirements. It also states that the light is classified by U.L. in accordance with the '72 COLREGS. This is the only documentation needed by a vessel in this size range for navigation lights to certify light construction compliance with the '72 COLREGS and the U.S. Inland rules.

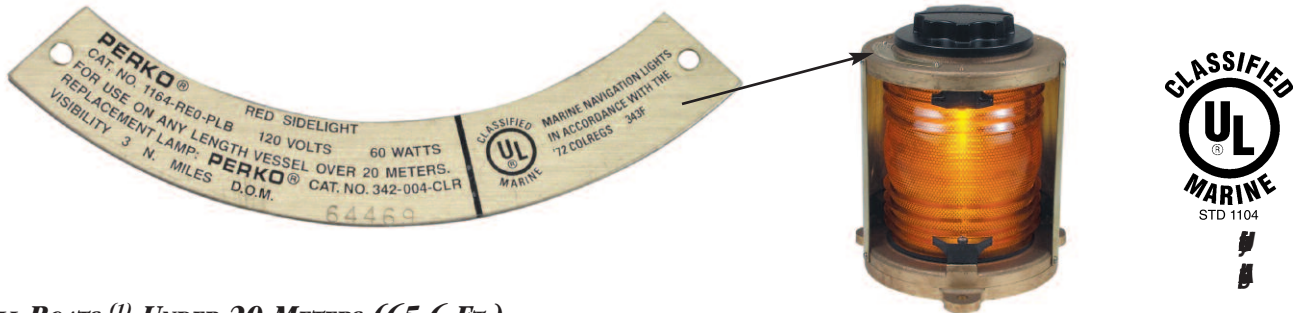

## SMALL BOATS (1) UNDER 20 METERS (65.6 FT.)

U.S. Requirements for smaller vessels are less strict and they differ depending on when the boat was built.

### SMALL BOATS BUILT BEFORE 11/1/03

Lights for these boats must be manufactured in accordance with the American Boat and Yacht Council (A.B.Y.C.) Standard A-16. The primary means of certification recognized in the United States for lights for these boats is through the National Marine Manufacturers' Association (NMMA) certification procedure. USCG approved lights as described below are also approved for these applications. All PERKO small boat lights designed for use on boats built before 11/1/03 are certified under this NMMA Certification Procedure. All lights certified under this procedure are required to permanently carry the mark "A-16" visibly displayed when the light is installed.

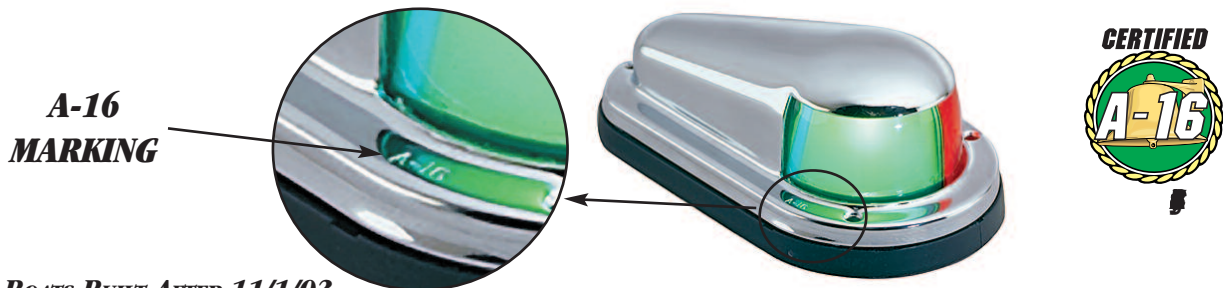

### SMALL BOATS BUILT AFTER 11/1/03

The only recognized means of certification of lights for these boats is the new USCG approval system. This system utilizes independent 3rd party USCG approved labs to conduct some of the tests required for the A-16 certification. On all USCG approved lights, the permanent markings USCG-1, USCG-2 or USCG-3 (depending on whether the light is a 1-mile, 2-mile or 3-mile light) must be visible when the light is installed. Note that certifications may vary with voltage (e.g. USCG approved for 12-volt and A-16 certified for 24-volt).

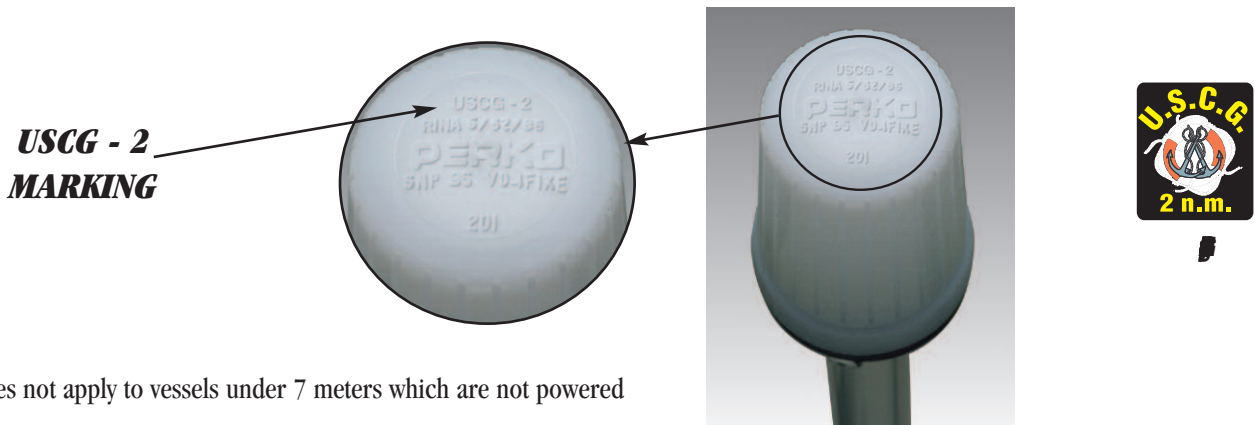

(1) Does not apply to vessels under 7 meters which are not powered



## STATE-OF-THE-ART TECHNOLOGY

Navigation Lights for  
Vessels Under 20 Meters



# The L.E.D. Family

## Navigation Lights For Powerboats & Sailboats

- White All-Round Lights
- Side Lights
- Stern Lights
- Masthead Lights
- Utility Lights
- Cockpit Lights



All Removable Polelights & Bases

**ALL NEW**  
**Gold Plated**  
**CONTACTS**

Look for this Symbol Throughout  
the Catalog to Identify Products  
that have been Improved  
with Gold Plated Contacts



### Why Gold Contacts?

- Improved Corrosion Resistance
- More Reliable Electrical Connections
- Long Life in Harsh Environments

## SETS OF NAVIGATION LIGHTS

The lights that appear on this page are sets of navigation lights that complement each other in styling and design. They appear on the following pages grouped by function, rather than by style; therefore, use this page as a guide for selection of individual lights to form a series. A representative variety of available finishes (e.g. white, chrome or black) are shown below -- refer to the lights as listed on the following pages for specific availability in the desired style.

Navigation Lights for Vessels Under 20 Meters

*CERTIFIED FOR USE ON POWER DRIVEN VESSELS UNDER 20 METERS (65.6 FT.) IN LENGTH.*



**Fig. 602 L.E.D. Side Lights**  
See Page 8



**Fig. 170 Series L.E.D. Side Lights**  
See Page 31

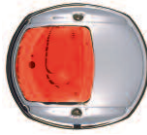

**Fig. 232 Side Lights**  
See Page 11



**Fig. 229 Bi-Color**  
See Page 3

*CERTIFIED FOR USE ON POWER DRIVEN VESSELS UNDER 20 METERS (65.6 FT.) IN LENGTH.*



**Fig. 253 Side Lights**  
See Page 12



**Fig. 252 Bi-Color**  
See Page 4



**Fig. 254 Side Lights**  
See Page 9



**Fig. 228 Side Lights**  
See Page 11



**Fig. 227 Bi-Color**  
See Page 3

*\*CERTIFIED FOR USE ON SAIL OR POWER DRIVEN VESSELS UNDER 12 METERS (39.4 FT.) IN LENGTH.*



**Fig. 915 Side Lights\***  
See Page 13



**Fig. 904 Bi-Color\***  
See Page 5



**Fig. 955 Side Lights**  
See Page 9



\*Certified for Replacement Use Only.

\*Certified for Replacement Use Only.

*\*CERTIFIED FOR USE ON SAIL OR POWER DRIVEN VESSELS UNDER 12 METERS (39.4 FT.) IN LENGTH.*



**Fig. 963 Side Lights**  
See Page 12



**Fig. 972 Bi-Color**  
See Page 4



**Fig. 965 Stern**  
See Page 14



**Fig. 945 Stern\***  
See Page 14



**Fig. 964 Masthead**  
See Page 17

\*Certified for Replacement Use Only.

*FIG. 120 SERIES: CERTIFIED FOR USE ON SAIL OR POWER DRIVEN VESSELS UNDER 12 METERS (39.4 FT.) IN LENGTH.*

*FIG. 170 SERIES: FOR USE ON SAIL OR POWER DRIVEN VESSELS UNDER 20 METERS (65.6 FT.) IN LENGTH.*



**Fig. 120/170 Side Lights**  
See Page 10



**Fig. 120/170 Bi-Color**  
See Page 32



**Fig. 120/170 Stern**  
See Page 15



**Fig. 120/170 Masthead**  
See Page 16

Note: This Series of Lights Also Appears on Pages 32 & 33 as a Complete Series.

## BI-COLOR LIGHTS

PATENT No. 4,500,947

**RED AND GREEN LENSES, 12 VOLT BULB INCLUDED**

**FIG. 229 - CERTIFIED FOR USE ON POWER DRIVEN VESSELS  
UNDER 20 METERS (65.6 FT.) IN LENGTH**



Navigation Lights for Vessels Under 20 Meters

**CONSTRUCTION:**

**\* CHROME PLATED BRONZE TOP  
WITH BLACK PLASTIC BASE**



**FIG. 229  
CHROME TOP**



**ORDERING INFORMATION**

Finish	Length Inches	Width Inches	Vertical Height Inches	Dealer Pkg. 5 Cards 1 Pc. per Card	OEM Bulk Pkg. 50 Pcs.	Screw Size	Ship Wt Carton Lbs DP/OEM Bulk
Chrome-12V	4	3	7/8	229 DP CHR	229 000 CHR	8	2.7/19.6

Spare Bulbs (2 per card), Cat. No. 71 DP CLR.

Spare Lens (1-Red/Green), Cat. No. 229 DP LNS.

Spare Black Base with Socket Assembly, Cat. No. 229 000 99A.

**FIG. 227 - CERTIFIED FOR USE ON POWER DRIVEN VESSELS  
UNDER 20 METERS (65.6 FT.) IN LENGTH**



**CONSTRUCTION:**

**\* CHROME PLATED ZINC ALLOY TOP  
WITH BLACK PLASTIC BASE**



**FIG. 227  
CHROME TOP**



**ORDERING INFORMATION**

Finish	Length Inches	Width Inches	Vertical Height Inches	Dealer Pkg. 5 Cards 1 Pc. per Card	OEM Bulk Pkg. 50 Pcs.	Screw Size	Ship Wt Carton Lbs DP/OEM Bulk
Chrome-12V	3-1/4	2-5/16	5/8	227 DP CHR	227 000 CHR	8	2.0/15.1

Spare Bulbs (2 per card), Cat. No. 71 DP CLR.

Spare Lens (1-Red/Green), Cat. No. 227 DP LNS.

Spare Black Base with Socket Assembly, Cat. No. 227 000 99A.



## BI-COLOR LIGHTS

PATENT No. 4,500,947

**RED AND GREEN LENSES, 12 VOLT BULB INCLUDED**

Navigation Lights for Vessels Under 20 Meters



**FIG. 252 - CERTIFIED FOR USE ON POWER DRIVEN VESSELS UNDER 20 METERS (65.6 FT.) IN LENGTH.**

**CONSTRUCTION OPTIONS:**

- \* **CHROME PLATED BRONZE TOP WITH BLACK PLASTIC BASE**
- \* **ALL BLACK PLASTIC**
- \* **ALL WHITE PLASTIC**

**FIG. 252 CHROME TOP**



**FIG. 252 BLACK**



**FIG. 252 WHITE**

**ORDERING INFORMATION**

Finish	Length Inches	Width Inches	Vertical Height Inches	Dealer Pkg. 5 Cards 1 Pc. per Card	OEM Bulk Pkg. 25 Pcs.	Screw Size	Ship Wt. Carton Lbs. DP/OEM Bulk
Chrome-12V	3-1/2	2-1/4	13/16	252 MB DP1	252 MB 12V	8	2.0/7.9
Black-12V	3-1/2	2-1/4	13/16	252 BB DP1	252 BB 12V	8	1.3/4.1
White-12V	3-1/2	2-1/4	13/16	252 WB DP1	252 WB 12V	8	1.3/4.2

Spare Bulbs (2 per card), Cat. No. 71 DP CLR.  
Spare Lens (1-Red/Green), Cat. No. 247 DP LNS.

Spare Black Base with Socket Assembly, Cat. No. 114 000 BLK.  
Spare White Base with Socket Assembly, Cat. No. 114 000 WHT.

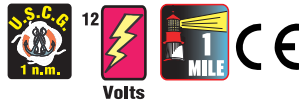

**FIGS. 1310/1161 - CERTIFIED FOR USE ON POWER DRIVEN VESSELS UNDER 12 METERS (39.4 FT.) IN LENGTH**

**CONSTRUCTION:**

- \* **BLACK PLASTIC BASE**

**FIG. 1310 - CHROME PLATED ZINC ALLOY TOP**

**FIG. 1161 - CHROME PLATED BRONZE TOP**



**FIGS. 1310 & 1161**

**ORDERING INFORMATION**

Dimensions Base Inches	Vertical Height Inches	Dealer Pkg. 5 Cards 1 Pc. per Card	OEM Bulk Pkg. 50 Pcs.	Screw Size	Ship Wt. Carton Lbs. DP/OEM Bulk
4 x 3-1/8	1	1310 DP CHR	1310 000 CHR	8	2.5/20.7
4 x 3-1/8	1	1161 DP CHR	1161 000 CHR	8	3.3/27

Spare Bulbs (2 per card), Cat. No. 71 DP CLR.  
Spare Base with Socket Assembly, Cat. No. 136.

Spare Lens Set (1-Red & 1-Green), Cat. No. 283 DPA LNS.



**FIG. 972 - CERTIFIED FOR USE ON SAIL OR POWER DRIVEN VESSELS UNDER 12 METERS (39.4 FT.) IN LENGTH**

**CONSTRUCTION:**

- \* **CHROME PLATED BRASS TOP WITH BLACK PLASTIC BASE HORIZONTAL SURFACE MOUNT**



**FIG. 972**

**ORDERING INFORMATION**

O.D. Length Inches	Vertical Height Inches	Dealer Pkg. 5 Cards 1 Pc. per Card	OEM Bulk Pkg. 25 Pcs.	Screw Size	Ship Wt. Carton Lbs. DP/OEM Bulk
2-3/8	7/8	972 DP CHR	972 000 CHR	4	1.3/4.7

Spare Bulbs (2 per card), Cat. No. 71 DP CLR.  
Spare Base with Socket Assembly, Cat. No. 135.

Spare Lens Set, Old Style Open Top (1 - Red & 1-Green), Cat. No. 296 DP LNS.

Spare Lens Set, New Style Closed Top (1 - Red & 1-Green), Cat. No. 297 DP LNS.



## BI-COLOR LIGHTS

PATENT No. 4,500,947

**RED AND GREEN LENSES, 12 VOLT BULB INCLUDED**

**FIG. 904 - CERTIFIED FOR REPLACEMENT USE ONLY ON SAIL OR POWER DRIVEN VESSELS UNDER 12 METERS (39.4 FT.) IN LENGTH**



**CONSTRUCTION:**

\* **CHROME PLATED BRASS TOP WITH BLACK PLASTIC BASE HORIZONTAL SURFACE MOUNT**



**ORDERING INFORMATION**

Length Inches	Width Inches	Vertical Height Inches	Dealer Pkg. - 5 Cards 1 Pc. per Card	Screw Size	Ship Wt. Carton Lbs. Dealer Pkg.
4-1/4	2-1/8	7/8	904 DP CHR	4	1.6

Spare Bulbs (2 per card), Cat. No. 71 DP CLR. Spare Lens Set (1-Red & 1-Green), Cat. No. 296 DP LNS.  
Spare Base with Socket Assembly, Cat. No. 107.



**FIG. 904**

Navigation Lights for Vessels Under 20 Meters

**FIG. 1218 - CERTIFIED FOR REPLACEMENT USE ONLY ON POWER DRIVEN VESSELS UNDER 12 METERS (39.4 FT.) IN LENGTH**



**CONSTRUCTION:**

\* **CHROME PLATED ZINC ALLOY WITH FLAG STAFF SOCKET.**



**ORDERING INFORMATION**

Dimensions Base Inches	Vertical Height Inches	I.D. Socket Inches	Dealer Pkg. - 5 Cards 1 Pc. per Card	Screw Size	Ship Wt. Carton Lbs. Dealer Pkg.
6-3/4 x 3-7/8	1-5/8	3/4	1218 DP CHR	8	5.2

Spare Bulbs (2 per card), Cat. No. 71 DP CLR. Spare Lens Set (1-Red & 1-Green), Cat. No. 259 DPA LNS.  
Spare Socket Assembly, Cat. No. 1218 DP 99A.



**FIG. 1218**

## REMOVABLE BI-COLOR LIGHTS

**FIGS. 1612 & 1614 - CERTIFIED FOR USE ON SAIL OR POWER DRIVEN VESSELS UNDER 12 METERS (39.4 FT.) IN LENGTH**

**CONSTRUCTION:**

\* **BLACK PLASTIC TOP**

\* **WATERPROOF COVER FOR BASE**

**FIG. 1612 - CHROME PLATED BRASS AND BLACK PLASTIC BASE 3/4 INCH DIAMETER ANODIZED ALUMINUM TUBE WITH LOCKING COLLAR**

**FIG. 1614 - CHROME PLATED BRASS AND/OR BLACK SANTOPRENE CAP WITH PLAIN BLACK PLASTIC BASE 3/4 INCH DIAMETER ANODIZED ALUMINUM TUBE WITH THREADED COLLAR (NOT SHOWN)**



**ALL NEW Gold Plated CONTACTS**



**ORDERING INFORMATION**

Vertical Height Inches	O.D. Base Inches	Dealer Pkg. - 5 Cards 1 Pc. per Card	OEM Bulk Pkg. 50 Pcs.	Screw Size	Ship Wt. Carton Lbs. DP/OEM Bulk
9-13/16	2-1/4	1612 DP BLK	1612 000 BLK	8	3.9/20.4
9-13/16	1-15/16	1614 DP BLK	1614 000 BLK	8	3.9/20.4
9-13/16	1-15/16	1614 DP CHR	1614 000 CHR	8	3.9/20.4

Spare Bulbs (2 per card), Cat. No. 71 DP CLR. Replacement Pole Light For Fig.1612, Cat. No. 1612 DP 99A.  
Fig. 1612 Spare Mounting Base, Cat. No. 1045 P00 DP. Replacement Pole Light For Fig.1614, Cat. No. 1614 DP 99A.  
Fig. 1614 Spare Mounting Base (Chrome), Cat. No. 1049 P00 DPC. Fig. 1614 Spare Mounting Base (Black), Cat. No. 1049 P00 DPB.  
Spare Lens Set For Figs.1612 & 1614 (1-Red & 1-Green), Cat. No. 283 DPA LNS.



**FIG. 1612**



**FIG. 1614 BLK**



**FIG. 1614 CHR**

## REMOVABLE BI-COLOR LIGHTS

PATENT NO. 4,500,947

RED & GREEN LENSES, 12 VOLT BULB INCLUDED

**FIGS. 1211/1212/1296 - CERTIFIED FOR USE ON SAIL OR POWER DRIVEN VESSELS UNDER 12 METERS (39.4 FT.) IN LENGTH**

**FIGS. 1421/1422 - CERTIFIED FOR USE ON POWER DRIVEN VESSELS UNDER 20 METERS (65.6 FT.) IN LENGTH**

### CONSTRUCTION:

- \* BLACK PLASTIC TOP
- \* 3/4 INCH DIAMETER ANODIZED ALUMINUM TUBES
- \* WATERPROOF COVER OR WATER RESISTANT SLIDE COVER FOR BASE
- \* DECK ILLUMINATING UTILITY LIGHT
- \* STOW-A-WAY PLUG-IN TYPE POLES



**FIGS. 1211, 1296 & 1421**

- \* CHROME PLATED BRASS AND BLACK PLASTIC BASE

**FIGS. 1212 & 1422**

- \* CHROME PLATED ZINC ALLOY BASE
- \* POLE HAS A 5° ANGLE



### ORDERING INFORMATION

Vertical Height Inches	Dimensions Base Inches	Dealer Pkg. 5 Cards 1 Pc. per Card	OEM Bulk Pkg. 50 Pcs.	Screw Size	Ship Wt. Carton Lbs. DP/OEM Bulk
10	2-1/4 O.D.	1211 DP CHR	1211 000 CHR	8	4.2/23.6
10-7/16	3-3/4 x 1-3/4	1212 DP CHR	1212 000 CHR	8	5.1/23.6
10	3-1/2 x 1-1/2	1296 DP CHR	1296 000 CHR	8	4.4/23.5
9-9/16	2-1/4 O.D.	1421 DP CHR	1421 000 CHR	8	3.7/21.3
9-7/8	3-3/4 x 1-3/4	1422 DP CHR	1422 000 CHR	8	4.5/21.3

Spare Bulbs for Figs. 1211, 1212 & 1296 (2 per card), Cat. No. 71 DP CLR.  
 Spare Bulbs for Figs. 1421 & 1422 (2 per card), Cat. No. 338 DP1 CLR.  
 Spare Bulb for Utility Light, Cat. No. 64 000 CLR.  
 Spare Lens Set Figs. 1211, 1212 & 1296 (1-Red & 1-Green), Cat. No. 268 DP LNS.  
 Spare Lens Set Figs. 1421 & 1422 (1-Red & 1-Green), Cat. No. 241 DP LNS.  
 Spare Mounting Bases See Page #43.  
 Spare Replacement Pole Light for Figs. 1211 & 1296, Cat. No. 1211 DP 99A.  
 Spare Replacement Pole Light for Fig. 1212, Cat. No. 1212 DP 99A.  
 Spare Replacement Pole Light for Fig. 1421, Cat. No. 1421 DP 99A.  
 Spare Replacement Pole Light for Fig. 1422, Cat. No. 1422 DP 99A.



**FIGS. 1421 & 1422**



**FIG. 1421**  
0° Rake

**FIG. 1422**  
5° Rake

### Featuring

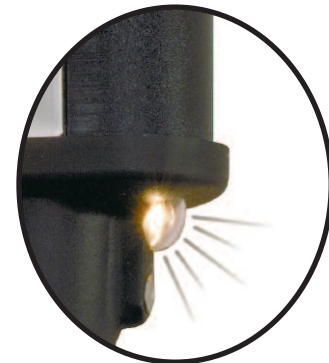

**DECK ILLUMINATING UTILITY LIGHT**  
 in the Rear Section of the Top,  
 Controlled by a Switch Located  
 on the Top Cover.

**FIG. 1211**



0° Rake



**FIG. 1212**



5° Rake



**FIG. 1296**



0° Rake

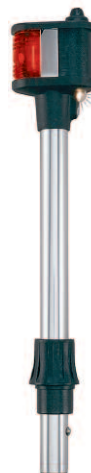

## TRI-COLOR LIGHTS

PATENT No. 4,500,947

**RED, GREEN AND CLEAR LENSES, 12 VOLT BULB INCLUDED**

**FIG. 200 TAB TRI-COLOR/WHITE ALL ROUND LIGHT  
CERTIFIED FOR USE ON VESSELS UNDER SAIL ALONE,  
UNDER 20 METERS (65.6 FT.) IN LENGTH**

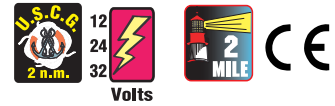

Navigation Lights for Vessels Under 20 Meters

**CONSTRUCTION:**

- \* **BASE MOUNT**
- \* **BLACK PLASTIC**
- \* **12, 24 OR 32 VOLT BULB INCLUDED**



**ORDERING INFORMATION**

Voltage	Vertical Height Inches	O.D. Base Inches	Dealer Pkg. - 5 Cards 1 Pc. per Card	Screw Size	Ship Wt. Carton Lbs. Dealer Pkg.
12	8-3/4	3-5/16	200 TAB DP1	10	6.1
24	8-3/4	3-5/16	200 TAB DP2	10	6.1
32	8-3/4	3-5/16	200 TAB DP3	10	6.1

Spare Bulb Information Top Section: Replace 12V with Cat. No. 375 12V 25W, Replace 24V with Cat. No. 375 24V 25W and Replace 32V with Cat. No. 375 32V 25W.  
Spare Bulb Information Bottom Section: Replace 12V with Cat. No. 375 12V 10W, Replace 24V with Cat. No. 375 24V 10W and Replace 32V with Cat. No. 375 32V 10W.



**FIG. 200 TAB**

**SPARE PARTS ORDERING INFORMATION**

Spare Lens Assembly Part Numbers are Determined by Replacing the Last Three Digits of the Catalog Number with the Letters "LNS" (example: 200 TAB LNS, for a Bi-Color Top Mount Lens Assembly).  
Spare Replacement Bulb Sockets: (single and lower for double) Cat. No. 93, (upper for double), Cat No. 95.

**FIG. 1201 TRI-COLOR LIGHT  
CERTIFIED FOR USE ON VESSELS UNDER SAIL ALONE  
UNDER 12 METERS (39.4 FT.) IN LENGTH**



**CONSTRUCTION:**

- \* **BLACK PLASTIC AND CHROME PLATED ZINC ALLOY TOP**
- \* **BLACK PLASTIC BASE**



**ORDERING INFORMATION**

Vertical Height Inches	Dimensions Base Inches	Dealer Pkg. - 5 Cards 1 Pc. per Card	Screw Size	Ship Wt. Carton Lbs. Dealer Pkg.
3-1/4	1 x 2-5/8	1201 DP BLK	8	2.1

Spare Bi-Color Lens Set (1-Red & 1-Green), Cat. No. 268 DP LNS.  
Spare Bulbs (2 per card), Cat. No. 71 DP CLR.  
Spare White Lenses (2 per card), Cat. No. 278 DP WHT.  
Spare Top Cap with Screw, Cat. No. 1158 DP BLK.



**FIG. 1201**

Navigation Lights for Vessels Under 20 Meters

**FIG. 602 - CERTIFIED FOR USE ON POWER DRIVEN VESSELS UNDER 20 METERS (65.6 FT.) IN LENGTH**



**CONSTRUCTION OPTIONS:**

- \* CHROME PLATED BRONZE
- \* WHITE EPOXY COATED BRONZE
- \* VERTICAL MOUNT
- \* LOW PROFILE - SMALL SIZE
- \* USES 10% OF THE ENERGY DRAW OF STANDARD LIGHTS
- \* LOW HEAT
- \* LONG LIFE
- \* WATER RESISTANT



**FIG. 602 WHITE**

L.E.D.'S

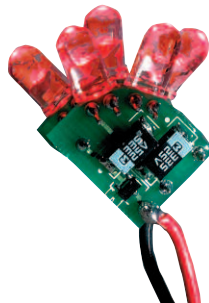

**FIG. 602 CHROME**



**ORDERING INFORMATION**

Finish	Voltage	Length Inches	Width Inches	Projection Overall Inches	Dealer Pkg. 1 Card 1 Pair per Card	OEM Bulk Package 1 Pair	Screw Size	Ship Wt. Carton Lbs. DP/OEM Bulk
Chrome	12	3-1/4	2	1-1/8	602 DP1 CHR	602 001 CHR	8	1.0/0.6
White	12	3-1/4	2	1-1/8	602 DP1 WHT	602 001 WHT	8	1.0/0.6
Chrome	24	3-1/4	2	1-1/8	602 DP2 CHR	602 002 CHR	8	1.0/0.6
White	24	3-1/4	2	1-1/8	602 DP2 WHT	602 002 WHT	8	1.0/0.6



## VERTICAL MOUNT SIDE LIGHTS

**RED AND GREEN LENSES, 12 VOLT BULBS INCLUDED**

**FIG. 254 - CERTIFIED FOR USE ON POWER DRIVEN VESSELS  
UNDER 20 METERS (65.6 FT.) IN LENGTH**

**CONSTRUCTION OPTIONS:**

- \* **CHROME PLATED BRONZE WITH BLACK PLASTIC BASE**
- \* **ALL BLACK PLASTIC**
- \* **ALL WHITE PLASTIC**



**FIG. 254  
CHROME**



**FIG. 254  
BLACK**

**FIG. 254  
WHITE**



**ORDERING INFORMATION**

Finish	Length Inches	Width Inches	Projection Overall Inches	Dealer Pkg. 5 Cards 1 Pair per Card	OEM Bulk Pkg. 10 Pair	Screw Size	Ship Wt. Carton Lbs. DP/OEM Bulk
Chrome	3-1/2	2-1/4	7/8	254 M DP1	254 M 12V	8	3.4/5.6
Black	3-1/2	2-1/4	7/8	254 B DP1	254 B 12V	8	2.4/3.5
White	3-1/2	2-1/4	7/8	254 W DP1	254 W 12V	8	2.4/3.5

Green Spare Lens Only, Cat. No. 277 DPG LNS.  
Red Spare Lens Only, Cat. No. 277 DPR LNS.  
Spare Base with Socket Assembly, Cat. No. 254 BLK/WHT 99A.  
12 Volt Spare Bulbs (2 per card), Cat. No. 71 DP8 CLR.  
24 Volt Spare Bulbs (2 per card), Cat. No. 72 DP8 CLR.

**FIG. 955 - CERTIFIED FOR USE ON SAIL OR POWER DRIVEN VESSELS  
UNDER 12 METERS (39.4 FT.) IN LENGTH**

**CONSTRUCTION:**

- \* **CHROME PLATED BRASS TOP WITH BLACK PLASTIC BASE**



**FIG. 955**



**ORDERING INFORMATION**

Length Inches	Width Inches	Projection Overall Inches	Dealer Pkg. 5 Cards 1 Pair per Card	OEM Bulk Pkg. 10 Pair	Screw Size	Ship Wt. Carton Lbs. DP/OEM Bulk
4-1/4	2-3/8	5/8	955 DP CHR	955 000 CHR	4	2.8/4.7

Green Side Light Only, Cat. No. 955 G00 CHR. Spare Lens Set (1-Red & 1-Green), Cat. No. 260 DP LNS.  
Red Side Light Only, Cat. No. 955 R00 CHR. Spare Base with Socket Assembly, Cat. No. 955 000 99A.  
Spare Bulbs (2 per card), Cat. No. 71 DP CLR.

**FIG. 1264 - CERTIFIED FOR REPLACEMENT USE ONLY POWER DRIVEN  
VESSELS UNDER 12 METERS (39.4 FT.) IN LENGTH**

**CONSTRUCTION:**

- \* **CHROME PLATED ZINC ALLOY  
WITH BLACK VINYL MOUNTING GASKET**

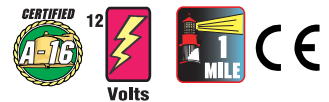

**FIG. 1264**



**ORDERING INFORMATION**

Length Inches	Width Inches	Projection Overall Inches	Dealer Pkg. 5 Cards 1 Pair per Card	Screw Size	Ship Wt. Carton Lbs. Dealer Pkg.
5-1/2	3-1/8	1-3/4	1264 DP CHR	8	6.6

Green Side Light Only, Cat. No. 1264 G00 CHR. Spare Lens Set (1-Red & 1-Green), Cat. No. 1264 DP LNS.  
Red Side Light Only, Cat. No. 1264 R00 CHR. Spare Socket Assembly, Cat. No. 1264 DP 99A.  
Spare Bulbs (2 per card), Cat. No. 71 DP CLR.

Navigation Lights for Vessels Under 20 Meters

## VERTICAL MOUNT SIDE LIGHTS

RED AND GREEN LENSES, 12 VOLT OR 24 VOLT BULBS INCLUDED

**FIG. 120 - CERTIFIED FOR USE ON SAIL OR POWER DRIVEN VESSELS UNDER 12 METERS (39.4 FT.) IN LENGTH (12 VOLTS)**

**FIG. 170 - CERTIFIED FOR USE ON SAIL OR POWER DRIVEN VESSELS UNDER 20 METERS (65.6 FT.) IN LENGTH (12 OR 24 VOLTS)**

**L.E.D.'S**  
Available  
See Page 31

**CONSTRUCTION OPTIONS:**

- \* CHROME PLATED BRASS TOP WITH BLACK PLASTIC BASE
- \* ALL BLACK PLASTIC
- \* ALL WHITE PLASTIC



**DIMENSIONS**

Ht. Overall Inches	Proj. Overall Inches	Width Inches	Screw Size
3-5/8	2-1/2	4-1/8	10



**Figs. 120 MSD & 170 MSD**



**Figs. 120 MP & 170 MP**

**FIG. 120**



**FIG. 120 ORDERING INFORMATION - 12 VOLT**

Description	Dealer Pkg.		Ship Wt.
	5 - Cards	OEM Bulk Pkg	Carton Lbs.
<b>Chrome</b>	1 Pc. per Card	5 Pcs.	Std Pkg/DP/OEM Bulk
Red Side Light	120 MP DP1	120 MP 12V	--/2.5/2.5
Green Side Light	120 MSD DP1	120 MSD 12V	--/2.5/2.5
<b>Black Plastic</b>			
Red Side Light	120 BP DP1	120 BP 12V*	0.5/2.3/--
Green Side Light	120 BSD DP1	120 BSD 12V	--/2.3/2.3
<b>White Plastic</b>			
Red Side Light	120 WP DP1	120 WP 12V	--/2.3/2.3
Green Side Light	120 WSD DP1	120 WSD 12V	--/2.3/2.3



**Figs. 120 BSD & 170 BSD**



**Figs. 120 BP & 170 BP**

**FIG. 170**



**Figs. 120 WSD & 170 WSD**



**Figs. 120 WP & 170 WP**

**FIG. 170 ORDERING INFO - 12 VOLT**

Description	Dealer Pkg.		Ship Wt.
	1 Pc. per Card	OEM Bulk Pkg	Carton Lbs.
<b>Chrome</b>		5 Pcs	Std Pkg/DP/OEM Bulk
Red Side Light	170 MP DP1	170 MP 12V*	0.6/2.5/--
Green Side Light	170 MSD DP1	170 MSD 12V	--/2.5/2.5
<b>Black Plastic</b>			
Red Side Light	170 BP DP1	170 BP 12V	--/2.3/2.3
Green Side Light	170 BSD DP1	170 BSD 12V	--/2.3/2.3
<b>White Plastic</b>			
Red Side Light	170 WP DP1	170 WP 12V	--/2.3/2.3
Green Side Light	170 WSD DP1	170 WSD 12V	--/2.3/2.3

**FIG. 170 ORDERING INFO - 24 VOLT**

Description	Dealer Pkg.		Ship Wt.
	1 Pc. per Card	Std Pkg 1 Pc.	Carton Lbs.
<b>Chrome</b>			
Red Side Light	170 MP DP2	170 MP 24V	0.6/2.5
Green Side Light	170 MSD DP2	170 MSD 24V	0.6/2.5
<b>Black Plastic</b>			
Red Side Light	170 BP DP2	170 BP 24V	0.5/2.3
Green Side Light	170 BSD DP2	170 BSD 24V	0.5/2.3
<b>White Plastic</b>			
Red Side Light	170 WP DP2	170 WP 24V	0.5/2.3
Green Side Light	170 WSD DP2	170 WSD 24V	0.5/2.3

\* Available Std Pkg 1 Pc Only.

Navigation Lights for Vessels Under 20 Meters

## HORIZONTAL MOUNT SIDE LIGHTS

**RED AND GREEN LENSES, 12 VOLT BULBS INCLUDED**

**FIG. 232 - CERTIFIED FOR USE ON POWER DRIVEN VESSELS  
UNDER 20 METERS (65.6 FT.) IN LENGTH**



**CONSTRUCTION:**

**\* CHROME PLATED BRONZE TOP  
WITH BLACK PLASTIC BASE**



**FIG. 232**



**ORDERING INFORMATION**

Finish	Length Inches	Width Inches	Vertical Height Inches	Dealer Pkg. 5 Cards 1 Pair per Card	OEM Bulk Pkg. 25 Pair	Screw Size	Ship Wt. Carton Lbs. DP/OEM Bulk
Chrome-12V	4	3	7/8	232 DP CHR	232 000 CHR	8	4.8/19.3

Spare Bulbs (2 per card), Cat. No. 71 DP CLR.  
Spare Lens (1-Red), Cat. No. 232 DPR LNS.

Spare Lens (1-Green), Cat. No. 232 DPG LNS.  
Spare Black Base with Socket Assembly, Cat. No. 229 000 99A.

**FIG. 228 - CERTIFIED FOR USE ON POWER DRIVEN VESSELS  
UNDER 20 METERS (65.6 FT.) IN LENGTH**



**CONSTRUCTION:**

**\* CHROME PLATED ZINC ALLOY TOP  
WITH BLACK PLASTIC BASE**



**FIG. 228**

**ORDERING INFORMATION**

Length Inches	Width Inches	Vertical Height Inches	Dealer Pkg. 5 Cards 1 Pair per Card	OEM Bulk Pkg. 25 Pairs	Screw Size	Ship Wt. Carton Lbs. DP/OEM Bulk
3-1/4	2-5/16	5/8	228 DP CHR	228 000 CHR	8	3.7/15.1

Spare Red Lens, Cat. No. 228 DPR LNS.

Spare Green Lens, Cat. No. 228 DPG LNS.

Spare Black Base with Socket Assembly, Cat. No. 227 000 99A.

Spare Bulbs (2 per card), Cat. No. 71 DP CLR.



Navigation Lights for  
Vessels Under 20 Meters

## HORIZONTAL MOUNT SIDE LIGHTS

RED AND GREEN LENSES, 12 VOLT BULBS INCLUDED

Navigation Lights for Vessels Under 20 Meters



**FIG. 253 - CERTIFIED FOR USE ON POWER DRIVEN VESSELS UNDER 20 METERS (65.6 FT.) IN LENGTH**

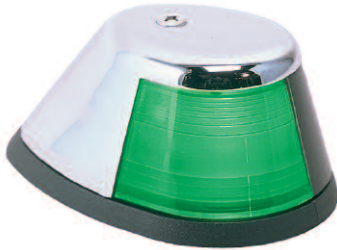

**FIG. 253 CHROME**



**CONSTRUCTION OPTIONS:**

- \* CHROME PLATED BRONZE TOP WITH BLACK PLASTIC BASE
- \* ALL BLACK PLASTIC
- \* ALL WHITE PLASTIC



**FIG. 253 WHITE**

**FIG. 253 BLACK**

**ORDERING INFORMATION**

Length Finish	Width Inches	Height Inches	Vertical 5 Cards Inches	Dealer Pkg. Bulk Pkg. 1 Pair per Card	OEM Screw 10 Pair	Carton Lbs. Size	Ship Wt.	
							DP/OEM	Bulk
Chrome	3-1/2	2-1/4	13/16	253 M DP1	253 M 12V	8	3.8	6.4
Black	3-1/2	2-1/4	13/16	253 B DP1	253 B 12V	8	2.2	3.2
White	3-1/2	2-1/4	13/16	253 W DP1	253 W 12V	8	2.2	3.3

Green Spare Lens Only, Cat. No. 273 DPG LNS.  
 Red Spare Lens Only, Cat. No. 273 DPR LNS.  
 Spare Base with Socket Assembly, Cat. No. 114 000 BLK/WHT.  
 Spare Bulbs (2 per card), Cat. No. 71 DP CLR.



**FIG. 963 - CERTIFIED FOR USE ON SAIL OR POWER DRIVEN VESSELS UNDER 12 METERS (39.4 FT.) IN LENGTH**



**CONSTRUCTION:**

- \* CHROME PLATED BRASS TOP WITH BLACK PLASTIC BASE



**FIG. 963**

**ORDERING INFORMATION**

O.D. Base Inches	Vertical Height Inches	Dealer Pkg. 5 Cards 1 Pair per Card	OEM Bulk Pkg. 10 Pair	Screw Size	Ship Wt. Carton Lbs. DP/OEM Bulk
2-3/8	7/8	963 DP CHR	963 000 CHR	4	2.5/3.9

Green Side Light Only, Cat. No. 963 G00 CHR. Spare Lens Set, Old Style Open Top (1-Red & 1-Grn), Cat. No. 281 DPA LNS.  
 Red Side Light Only, Cat. No. 963 R00 CHR. Spare Lens Set, New Style Closed Top (1-Red & 1-Grn), Cat. No. 295 DP LNS.  
 Spare Bulbs (2 per card), Cat. No. 71 DP CLR. Spare Base with Socket Assembly, Cat. No. 135.



## HORIZONTAL MOUNT SIDE LIGHTS

RED AND GREEN LENSES, 12 VOLT BULBS INCLUDED

**FIGS. 1601/1602 - CERTIFIED FOR USE ON SAIL OR POWER DRIVEN VESSELS UNDER 12 METERS (39.4 FT.) IN LENGTH**



**CONSTRUCTION:**

\* **BLACK PLASTIC**

**FIG. 1601 - NORMAL "BASE-DOWN" MOUNT**

**FIG. 1602 - INVERTED "BASE-UP" MOUNT**

**GREAT FOR PONTOON BOATS**



**FIG. 1601**



**FIG. 1602**



**ORDERING INFORMATION**

Vertical Height Inches	Height Overall Inches	Dimensions Base Inches	Dealer Pkg. 5 Cards 1 Pair per Card	OEM Bulk Pkg. 25 Pair	Screw Size	Ship Wt. Carton Lbs. DP/OEM Bulk
1-1/4	1-7/8	1-1/8 x 3	1601 DP BLK	1601 000 BLK	8	2.7/10.2
1-1/4	1-7/8	1-1/8 x 3	1602 DP BLK	1602 000 BLK	8	2.6/10.2

Spare Bulbs (2 per card), Cat No. 71 DP CLR.

Red Spare Lens Only, Cat. No. 298 DPR LNS.

Spare Base with Socket Assembly, Cat. No. 139 000 BLK.

Green Spare Lens Only, Cat. No. 298 DPG LNS.

**FIG. 915 - CERTIFIED FOR REPLACEMENT USE ONLY ON SAIL OR POWER DRIVEN VESSELS UNDER 12 METERS (39.4 FT.) IN LENGTH**



**CONSTRUCTION:**

\* **CHROME PLATED BRASS TOP WITH BLACK PLASTIC BASE**



**FIG. 915**



**ORDERING INFORMATION**

Length Inches	Width Inches	Vertical Height Inches	Dealer Pkg. 5 Cards 1 Pair per Card	Screw Size	Ship Wt. Carton Lbs. Dealer Pkg.
4-1/4	2-3/8	7/8	915 DP CHR	4	3.0

Green Side Light Only, Cat. No. 915 G00 CHR.

Spare Lens Set, Old Style Open Top (1-Red & 1-Green), Cat. No. 281 DPA LNS.

Red Side Light Only, Cat. No. 915 R00 CHR.

Spare Lens Set, New Style Closed Top (1-Red & 1-Green), Cat. No. 295 DP LNS.

Spare Bulbs (2 per card), Cat. No. 71 DP CLR.

Spare Base with Socket Assembly, Cat. No. 107.

## HORIZONTAL & VERTICAL MOUNT STERN LIGHTS

CLEAR LENSES, 12 VOLT BULB INCLUDED

Navigation Lights for Vessels Under 20 Meters



**FIG. 945 - CERTIFIED FOR REPLACEMENT USE ONLY ON SAIL OR POWER DRIVEN VESSELS UNDER 20 METERS (65.6 FT.) IN LENGTH**

**FIG. 965 - CERTIFIED FOR USE ON SAIL OR POWER DRIVEN VESSELS UNDER 20 METERS (65.6 FT.) IN LENGTH**

**FIG. 945**  
Vertical Mt.



**FIG. 965**  
Horizontal Mount

**CONSTRUCTION:**  
\* CHROME PLATED BRASS TOP WITH BLACK PLASTIC BASE



### ORDERING INFORMATION

	O.D. Base	Vertical Height	Dealer Pkg. 5 Cards	OEM Bulk Pkg. 25 Pcs.	Screw Size	Ship Wt. Carton Lbs. DP/OEM Bulk
Mount	Inches	Inches	1 Pc. per Card	25 Pcs.	Size	DP/OEM Bulk
Vertical	2-3/8	7/8	945 DP CHR	-----	4	1.4/--
Horizontal	2-3/8	3/4	965 DP CHR	965 000 CHR	4	1.4/4.9

Spare Bulbs (2 per card), Cat. No. 71 DP CLR. Spare Lens For Fig. No. 945, Cat. No. 74 DP WHT. Spare Base and Socket Assembly For Fig. 945, Cat. No. 945 DP 99A. Spare Old Style (Open Top) Lens For Fig. No. 965, Cat. No. 281 DPA WHT. Spare Base and Socket Assembly For Fig. 965, Cat. No. 135. Spare New Style (Closed Top) Lens For Fig. No. 965, Cat. No. 295 DP WHT.



**FIG. 939 - CERTIFIED FOR USE ON SAIL OR POWER DRIVEN VESSELS UNDER 20 METERS (65.6 FT.) IN LENGTH**

**CONSTRUCTION:**

\* CHROME PLATED BRASS TOP WITH BLACK PLASTIC BASE  
\* FLUSH MOUNT



**FIG. 939**  
Vertical Mt.

### ORDERING INFORMATION

Dimensions	Depth	Dealer Pkg. 5 Cards	OEM Bulk Pkg. 20 Pcs.	Screw Size	Ship Wt. Carton Lbs. DP/OEM Bulk
Inches	Inches	1 Pc. per Card	20 Pcs.	Size	DP/OEM Bulk
5-3/16 x 3-3/8	1-1/2	939 DP1 12V	939 001 12V	8	2.5/7.1

Spare Bulbs (2 per card), Cat. No. 70 DP0 CLR. Spare Socket Assembly, Cat. No. 939 DP1 99A. Spare Lens with Gasket, Cat. No. 284 DP CLR. Spare Mounting Flange, Cat. No. 939 000 99C.



**FIG. 946 - FOR USE ON SAIL OR POWER DRIVEN VESSELS UNDER 20 METERS (65.6 FT.) IN LENGTH**

**CONSTRUCTION:**

\* FLUSH MOUNT  
\* CHROME PLATED BRASS BEZEL WITH BLACK PLASTIC BASE  
\* WHITE PLASTIC BEZEL WITH BLACK PLASTIC BASE



**FIG. 946**  
CHROME  
Vertical Mount



**FIG. 946**  
WHITE  
Vertical Mount

### ORDERING INFORMATION

Finish	O.D. Inches	Depth Inches	Dealer Pkg. 5 Cards	OEM Bulk Pkg. 25 Pcs.	Screw Size	Ship Wt. Carton Lbs. DP/OEM Bulk
	Inches	Inches	1 Pc. per Card	25 Pcs.	Size	DP/OEM Bulk
Chrome	3	1	946 DP1 12V	946 001 12V	8	1.5/5.2
White	3	1	946 DP1 WHT	946 001 WHT	8	1.5/5.2

Spare Bulbs (2 per card), Cat. No. 70 DP0 CLR. Spare Lens with Gasket, Cat. No. 946 DP 99A. Spare Socket Assembly, Cat. No. 946 DP1 99B. Spare Mounting Flange, Cat. No. 946 000 99C.

## VERTICAL MOUNT STERN LIGHTS

CLEAR LENS, COMPLETE WITH 12 VOLT OR 24 VOLT BULB WHERE SPECIFIED

Navigation Lights for Vessels Under 20 Meters

**FIG. 120 - CERTIFIED FOR USE ON SAIL OR POWER DRIVEN VESSELS UNDER 12 METERS (39.4 FT.) IN LENGTH (12 VOLTS)**

**FIG. 120**

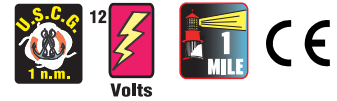

**FIG. 170 - CERTIFIED FOR USE ON SAIL OR POWER DRIVEN VESSELS UNDER 20 METERS (65.6 FT.) IN LENGTH (12 OR 24 VOLTS)**

**FIG. 170**



**L.E.D.'S**  
Available  
See Page 31

**CONSTRUCTION OPTIONS:**

- \* CHROME PLATED BRASS TOP WITH BLACK PLASTIC BASE
- \* ALL BLACK PLASTIC
- \* ALL WHITE PLASTIC



**ORDERING INFORMATION - FOR 12 VOLT LIGHTS**

Finish	Height Overall Inches	Projection Overall Inches	Width Inches	Dealer Pkg.		Screw Size	Ship Wt. Carton Lbs.
				5 Cards 1 Pc. per Card	OEM Bulk Pkg 5 Pcs.		
<b>Fig. 120</b>							
Chrome	3-5/8	2-1/2	4-1/8	120 MSN DP1	120 MSN 12V*	10	0.6/2.5/--
Black	3-5/8	2-1/2	4-1/8	120 BSN DP1	120 BSN 12V*	10	0.5/2.3/--
White	3-5/8	2-1/2	4-1/8	120 WSN DP1	120 WSN 12V	10	--/2.3/2.3
<b>Fig. 170</b>							
Chrome	3-5/8	2-1/2	4-1/8	170 MSN DP1	170 MSN 12V	10	--/2.5/2.5
Black	3-5/8	2-1/2	4-1/8	170 BSN DP1	170 BSN 12V*	10	0.5/2.3/--
White	3-5/8	2-1/2	4-1/8	170 WSN DP1	170 WSN 12V*	10	0.5/2.3/--



**Figs. 120 MSN & 170 MSN**



**Figs. 120 BSN & 170 BSN**



**ORDERING INFORMATION - FOR 24 VOLT LIGHTS**

Finish	Height Overall Inches	Projection Overall Inches	Width Inches	Dealer Pkg.		Screw Size	Ship Wt. Carton Lbs.
				5 Cards 1 Pc. per Card	Std Pkg. 1 Pc.		
Chrome	3-5/8	2-1/2	4-1/8	170 MSN DP2	170 MSN 24V	10	0.6/2.5
Black	3-5/8	2-1/2	4-1/8	170 BSN DP2	170 BSN 24V	10	0.5/2.3
White	3-5/8	2-1/2	4-1/8	170 WSN DP2	170 WSN 24V	10	0.5/2.3



**Figs. 120 WSN & 170 WSN**

\* Available Std Pkg 1 Pc Only.

Note: See Pages 32 & 33 for Complete Series, 24 Volt Options & Spare Parts Ordering Information.

**FIG. 1332 - CERTIFIED FOR REPLACEMENT USE ONLY ON SAIL OR POWER DRIVEN VESSELS UNDER 20 METERS (65.6 FT.) IN LENGTH**



**CONSTRUCTION:**

- \* CHROME PLATED ZINC ALLOY WITH BLACK PLASTIC BASE



**ORDERING INFORMATION - FOR 12V LIGHTS**

Length Inches	Width Inches	Dealer Pkg. 5 Cards 1 Pc. per Card	Screw Size	Ship Wt. Carton Lbs. Dealer Pkg
3-3/4	1-1/2	1332 DP CHR	4	1.8



**FIG. 1332**

Spare 12V Bulbs (2 per card), Cat. No. 71 DP CLR. Spare Lenses (2 per card) Cat. No. 278 DP WHT.

**NOTE: To Use This Light in a A-16 CERTIFIED 24 VOLT SYSTEM, ORDER REPLACEMENT BULBS (2 PER CARD) CAT. NO. 72 DP1 CLR**

## VERTICAL SURFACE MOUNT MASTHEAD LIGHTS

CLEAR LENS, COMPLETE WITH 12 VOLT OR 24 VOLT BULB WHERE SPECIFIED

Navigation Lights for Vessels Under 20 Meters

**FIG. 120**



**FIG. 120 - CERTIFIED FOR USE ON SAIL OR POWER DRIVEN VESSELS UNDER 12 METERS (39.4 FT.) IN LENGTH**

**FIG. 170 - CERTIFIED FOR USE ON SAIL OR POWER DRIVEN VESSELS UNDER 20 METERS (65.6 FT.) IN LENGTH**

**FIG. 170**



**CONSTRUCTION OPTIONS:**

- \* CHROME PLATED BRASS TOP WITH BLACK PLASTIC BASE
- \* ALL BLACK PLASTIC
- \* ALL WHITE PLASTIC

**L.E.D.'s Available**  
See Page 31



**Figs. 120 MM & 170 MM**



**Figs. 120 BM & 170 BM**



**Figs. 120 WM & 170 WM**

**ORDERING INFORMATION - FOR 12 VOLT LIGHTS**

Finish	Height Overall Inches	Projection Overall Inches	Width Inches	Dealer Pkg.		Screw Size	Ship Wt. Carton Lbs.
				5 Cards 1 Pc. per Card	OEM Bulk Pkg 5 Pcs.		
<b>Fig. 120</b>							
Chrome	3-5/8	2-1/2	4-1/8	120 MM DP1	120 MM 12V*	10	0.6/2.5/--
Black	3-5/8	2-1/2	4-1/8	120 BM DP1	120 BM 12V*	10	0.5/2.3/--
White	3-5/8	2-1/2	4-1/8	120 WM DP1	120 WM 12V	10	--/2.3/2.3
<b>Fig. 170</b>							
Chrome	3-5/8	2-1/2	4-1/8	170 MM DP1	170 MM 12V	10	-- /2.5/2.5
Black	3-5/8	2-1/2	4-1/8	170 BM DP1	170 BM 12V*	10	0.5/2.3/--
White	3-5/8	2-1/2	4-1/8	170 WM DP1	170 WM 12V*	10	0.5/2.3/--

**ORDERING INFORMATION - FOR 24 VOLT LIGHTS**

Finish	Height Overall Inches	Projection Overall Inches	Width Inches	Dealer Pkg.		Screw Size	Ship Wt. Carton Lbs.
				5 Cards 1 Pc. per Card	Std. Pkg. 1 Pc.		
Chrome	3-5/8	2-1/2	4-1/8	170 MM DP2	170 MM 24V	10	0.6/2.5/--
Black	3-5/8	2-1/2	4-1/8	170 BM DP2	170 BM 24V	10	0.5/2.3/--
White	3-5/8	2-1/2	4-1/8	170 WM DP2	170 WM 24V	10	0.5/2.3/--

\* Available Std Pkg 1 Pc Only.

NOTE: See Pages 32 & 33 for Complete Series, 24 Volt Options and Spare Parts Ordering Information.

## COMBINATION MASTHEAD DECK SPREADER LIGHT

**FIG. 120 BMD**



**FIG. 120 BMD - CERTIFIED FOR USE ON SAIL OR POWER DRIVEN VESSELS UNDER 12 METERS (39.4 FT.) IN LENGTH**

**FIG. 170 BMD - CERTIFIED FOR USE ON SAIL OR POWER DRIVEN VESSELS UNDER 20 METERS (65.6 FT.) IN LENGTH**

**FIG. 170 BMD**



**CONSTRUCTION:**

- \* BLACK PLASTIC



**ORDERING INFORMATION - 12 VOLT**

Vertical Height Inches	Projection Overall Inches	Overall Height Inches	Width Inches	Dealer Pkg.		Screw Size	Ship Wt. Carton Lbs.
				5 Cards 1 Pc. per Card	Std Pkg 1 Pc.		
4-1/2	4-3/4	7	4-1/8	120 BMD DP1	120 BMD 12V	10	0.9/5.4
4-1/2	4-3/4	7	4-1/8	170 BMD DP1	170 BMD 12V	10	0.9/5.4

NOTE: See Page 32 for Spare Parts Ordering Information





## HORIZONTAL & VERTICAL MOUNT MASTHEAD LIGHTS

CLEAR LENS, 12 VOLT BULB INCLUDED

**FIG. 964 - CERTIFIED FOR REPLACEMENT USE ONLY ON SAIL OR POWER DRIVEN VESSELS UNDER 12 METERS (39.4 FT.) IN LENGTH**



**CONSTRUCTION:**

\* **CHROME PLATED BRASS TOP WITH BLACK PLASTIC BASE**



**ORDERING INFORMATION**

O.D. Base Inches	Vertical Height Inches	Dealer Pkg. - 5 Cards 1 Pc. per Card	Screw Size	Ship Wt. Carton Lbs. Dealer Pkg
2-3/8	7/8	964 DP CHR	4	1.3



**FIG. 964**  
HORIZONTAL MOUNT

Spare Old Style (Open Top) Lens, Cat. No. 281 DPA WHT.  
Spare New Style (Closed Top) Lens, Cat. No. 295 DP WHT.

Spare Base with Socket Assembly, Cat. No. 135.  
Spare Bulbs (2 per card), Cat. No. 71 DP CLR.

**FIG. 1331 - CERTIFIED FOR USE ON SAIL OR POWER DRIVEN VESSELS UNDER 20 METERS (65.6 FT.) IN LENGTH**



**CONSTRUCTION:**

\* **CHROME PLATED ZINC ALLOY WITH BLACK PLASTIC BASE**



**ORDERING INFORMATION**

Length Inches	Width Inches	Dealer Pkg. 5 Cards 1 Pc. per Card	OEM Bulk Pkg. 50 Pcs.	Screw Size	Ship Wt. Carton Lbs. DP/OEM Bulk
3-3/4	1-1/2	1331 DP CHR	1331 000 CHR	4	1.7/13.8



**FIG. 1331**  
VERTICAL MOUNT

Spare Bulbs (2 per card), Cat. No. 71 DP CLR.

Spare Lenses (2 per card), Cat. No. 278 DP WHT.

**FIG. 1178 - CERTIFIED FOR USE ON VESSELS UNDER 20 METERS (65.6 FT.) IN LENGTH**



**CONSTRUCTION:**

\* **BLACK PLASTIC AND CHROME PLATED ZINC ALLOY TOP WITH BLACK PLASTIC BASE**



**ORDERING INFORMATION**

Vertical Height Inches	Dimensions Base Inches	Dealer Pkg. 5 Cards 1 Pc. per Card	OEM Bulk Pkg. 50 Pcs.	Screw Size	Ship Wt. Carton Lbs. DP/OEM Bulk
3-1/4	1 x 2-5/8	1178 DP CHR	1178 000 CHR	8	1.7/13.5



**FIG. 1178**

Spare Bulbs (2 per card), Cat. No. 71 DP CLR.  
Spare Top Cap and Screw, Cat. No. 1158 DP BLK.

Spare Lenses (2 per card), Cat. No. 278 DP WHT.

Navigation Lights for Vessels Under 20 Meters

## COMBINATION MASTHEAD AND WHITE ALL-ROUND LIGHTS

CLEAR LENSES, TWO 12 VOLT BULBS INCLUDED

Navigation Lights for Vessels Under 20 Meters



**FIGS. 1181/1184 - CERTIFIED FOR USE ON SAIL OR POWER DRIVEN VESSELS UNDER 20 METERS (65.6 FT.) IN LENGTH**

**CONSTRUCTION:**

- \* BLACK PLASTIC AND CHROME PLATED ZINC ALLOY TOP
- \* BLACK PLASTIC BASE
- \* 3/4 INCH DIAMETER ANODIZED ALUMINUM TUBES
- \* PLASTIC ADAPTERS FOR FLAT OR "V" TYPE MOUNT, CONTAINS NOTCH FOR THROUGH-BASE WIRING
- \* FOLD-DOWN, ADJUSTABLE ANGLE

**IMPROVED ADJUSTABILITY**



**FIG. 1181 - HORIZONTAL MOUNT**  
**FIG. 1184 - VERTICAL MOUNT**



**ORDERING INFORMATION**

Vertical Height Inches	Dimensions Base Inches	Dealer Pkg. 5 Cards 1 Pc. per Card	OEM Bulk Pkg. 50 Pcs.	Screw Size	Ship Wt. Carton Lbs. DP/OEM Bulk
12-13/16	2 x 1-1/2	1181 DP CHR	1181 000 CHR	8	4.9/40.9
12-13/16	2-1/4 x 5/8	1184 DP CHR	1184 000 CHR	8	4.7/39.8

Fig. 1181, Old Style Zinc Spare Bracket with Knob and End Plug, Cat. No. 1052 DPA CHR.  
 Fig. 1184, Old Style Zinc Spare Bracket with Knob and End Plug, Cat. No. 1054 DPA CHR.  
 Fig. 1181, New Style Plastic Spare Bracket with Knob and End Plug, Cat. No. 1052 DPB BLK.  
 Fig. 1184, New Style Plastic Spare Bracket with Knob and End Plug, Cat. No. 1054 DPB BLK.  
 Spare Knob for Old Style Bases Only, Cat. No. 1144 A00 BLK.



**FIGS. 1281/1284 - CERTIFIED FOR USE ON POWER DRIVEN VESSELS UNDER 12 METERS (39.4 FT.) IN LENGTH**

**CONSTRUCTION:**

- \* REDUCED GLARE DESIGN
- \* BLACK PLASTIC TOP WITH CLEAR PLASTIC LENS
- \* BLACK PLASTIC BASE
- \* 3/4 INCH DIAMETER ANODIZED ALUMINUM TUBE
- \* PLASTIC ADAPTERS FOR FLAT OR "V" TYPE MOUNT, CONTAINS NOTCH FOR THROUGH-BASE WIRING
- \* FOLD-DOWN, ADJUSTABLE ANGLE

**IMPROVED ADJUSTABILITY**

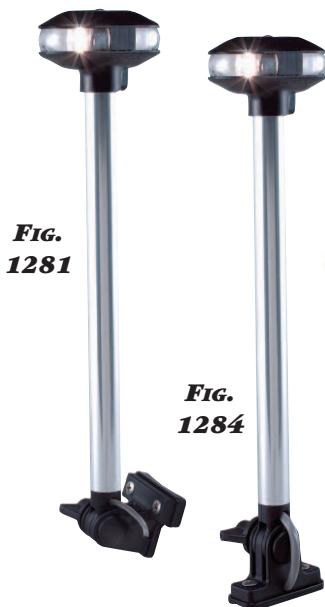

**FIG. 1281 - HORIZONTAL MOUNT**  
**FIG. 1284 - VERTICAL MOUNT**



**ORDERING INFORMATION**

Vertical Height Inches	Dimensions Base Inches	Dealer Pkg. 5 Cards 1 Pc. per Card	OEM Bulk Pkg. 50 Pcs.	Screw Size	Ship Wt. Carton Lbs. DP/OEM Bulk
12-3/16	2 x 1-1/2	1281 DP CHR	1281 000 CHR	8	4.1/32.4
12-3/16	2-1/4 x 5/8	1284 DP CHR	1284 000 CHR	8	4.0/30.8

Fig. 1281, Old Style Zinc Spare Bracket with Knob and End Plug, Cat. No. 1052 DPA CHR.  
 Fig. 1284, Old Style Zinc Spare Bracket with Knob and End Plug, Cat. No. 1054 DPA CHR.  
 Fig. 1281, New Style Plastic Spare Bracket with Knob and End Plug, Cat. No. 1052 DPB BLK.  
 Fig. 1284, New Style Plastic Spare Bracket with Knob and End Plug, Cat. No. 1054 DPB BLK.  
 Spare Knob for Old Style Bases Only, Cat. No. 1144 A00 BLK.

**SPARE PARTS ORDERING INFORMATION**

**FOR FIGS. 1181 & 1184**  
 Spare Bulbs (2 per card), Cat. No. 71 DP CLR.  
 Spare Lenses (2 per card), Cat. No. 278 DP WHT.  
 Spare Top Cap with Screw, Cat. No. 1158 DP BLK.

**FOR FIGS. 1281 & 1284**  
 Spare Bulbs (2 per card), Cat. No. 338 DP1 CLR.  
 Spare Lens Assembly, Cat. No. 240 DP LNS.

## COMBINATION MASTHEAD AND WHITE ALL-ROUND LIGHTS

CLEAR LENSES, TWO 12 VOLT BULBS INCLUDED

**FIGS. 1183, 1196 & 1197 - CERTIFIED FOR USE ON SAIL OR POWER DRIVEN VESSELS UNDER 20 METERS (65.6 FT.) IN LENGTH**

**CONSTRUCTION:**

- \* **BLACK PLASTIC AND CHROME PLATED ZINC ALLOY TOP**
- \* **BLACK PLASTIC BASE (FIGS. 1183 & 1196)**
- \* **3/4 INCH DIAMETER ANODIZED ALUMINUM TUBE**
- \* **FIGS. 1183 & 1196 - FIXED MOUNT**
- \* **FIG. 1197 - PLUG-IN MOUNT**



**ORDERING INFORMATION**

Vertical Height Inches	Dimensions Base Inches	Dealer Pkg. 5 Cards 1 Pc. per Card	OEM Bulk Pkg. 50 Pcs.	Screw Size	Ship Wt. Carton Lbs. DP/OEM Bulk
3-3/16	1 x 2-5/8	1183 DP CHR	1183 000 CHR	8	2.1/18.7
5-1/16	1 x 2-5/8	1196 DP1 CHR	1196 001 CHR	8	2.5/19.5
11-1/4	1 x 2-5/8	1196 DP2 CHR	1196 002 CHR	8	3.5/26.0



**ORDERING INFORMATION**

Vertical Height Inches	Length Tubing Inches	Dealer Pkg. - 5 Cards 1 Pc. per Card	OEM Bulk Pkg. 50 Pcs.	Ship Wt. Carton Lbs. DP/OEM Bulk
4	1	1197 DP CHR	1197 000 CHR	2.1/18.1



**FIG. 1183**



**FIG. 1196**



**FIG. 1197**

Navigation Lights for Vessels Under 20 Meters

**FIGS. 1236 & 1283 - CERTIFIED FOR USE ON POWER DRIVEN VESSELS UNDER 12 METERS (39.4 FT.) IN LENGTH**

**CONSTRUCTION:**

- \* **"REDUCED GLARE" DESIGN**
- \* **BLACK PLASTIC TOPS WITH BLACK PLASTIC BASE**
- \* **3/4 INCH DIAMETER ANODIZED ALUMINUM TUBE**
- \* **FIXED MOUNT**



**ORDERING INFORMATION**

Vertical Height Inches	Dimensions Base Inches	Dealer Pkg. 5 Cards 1 Pc. per Card	OEM Bulk Pkg. 50 Pcs.	Screw Size	Ship Wt. Carton Lbs. DP/OEM Bulk
4-1/4	1 x 2-5/8	1236 DP1 BLK	1236 001 BLK	8	1.8/10.8
10-1/2	1 x 2-5/8	1236 DP2 BLK	1236 002 BLK	8	2.5/17.2



**ORDERING INFORMATION**

Vertical Height Inches	Dimensions Base Inches	Dealer Pkg. 5 Cards 1 Pc. per Card	OEM Bulk Pkg. 50 Pcs.	Screw Size	Ship Wt. Carton Lbs. DP/OEM Bulk
2-1/4	1 x 2-5/8	1283 DP BLK	1283 000 BLK	8	1.6/10.0



**FIG. 1236**



**FIG. 1283**

**SPARE PARTS ORDERING INFORMATION**

**FOR FIGS. 1183, 1196 & 1197**  
 Spare Bulbs (2 per card), Cat. No. 71 DP CLR.  
 Spare Lenses (2 per card), Cat. No. 278 DP WHT.  
 Spare Top Cap with Screw, Cat. No. 1158 DP BLK.

**FOR FIGS. 1236 & 1283**  
 Spare Bulbs (2 per card), Cat. No. 338 DP1 CLR.  
 Spare Lens Assembly, Cat. No. 240 DP LNS.

## COMBINATION MASTHEAD AND WHITE ALL-ROUND LIGHTS

CLEAR LENSES, TWO 12 VOLT BULBS INCLUDED

Navigation Lights for Vessels Under 20 Meters



**FIGS. 1123 & 1124 - CERTIFIED FOR USE ON SAIL OR POWER DRIVEN VESSELS UNDER 20 METERS (65.6 FT.) IN LENGTH**

**CONSTRUCTION:**

- \* BLACK PLASTIC AND CHROME PLATED ZINC ALLOY TOP
- \* CHROME PLATED ZINC ALLOY MOUNTING BRACKET
- \* WATERPROOF COVER FOR MOUNTING BRACKET
- \* 3/4 INCH DIAMETER ANODIZED ALUMINUM TUBE
- \* STOW-A-WAY PLUG-IN TYPE
- \* PLASTIC ADAPTERS FOR FLAT OR "V" TYPE 45 DEGREE WINDSHIELDS



**FIG. 1123**

**FIG. 1123 - HORIZONTAL MOUNT**

**FIG. 1124 - VERTICAL MOUNT**

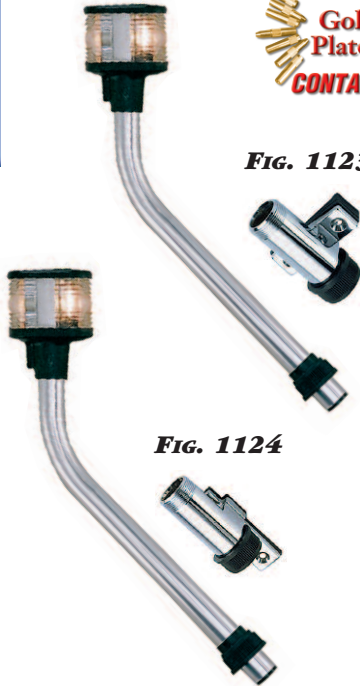

**FIG. 1124**

**ORDERING INFORMATION**



Vertical Height Inches	Dealer Pkg. - 5 Cards 1 Pc. per Card	OEM Bulk Pkg. 50 Pcs.	Screw Size	Ship Wt. Carton Lbs. DP/OEM Bulk
11-1/4	1123 DP1 CHR	1123 001 CHR	8	5.6/26.3
12-1/2	1124 DP1 CHR	1124 001 CHR	8	5.4/25.4
20-1/2	1123 DP2 CHR	1123 002 CHR	8	6.8/31.9
22	1124 DP2 CHR	1124 002 CHR	8	6.9/32.4

Spare Bulb (2 per card), Cat. No. 71 DP CLR.  
Spare Lenses (2 per card), Cat. No.278 DP WHT.  
Spare Top Cap with Screw, Cat. No. 1158 DP BLK.  
Spare Replacement Pole for Size No. 1, Cat. No. 1123 DP1 99A  
Spare Replacement Pole for Size No. 2, Cat. No. 1123 DP2 99A.

Spare Cap for Base, Cat No. 125 DP BLK.  
Fig. 1123 Spare Base with Socket Assembly, Cat No. 1123 DP 99A.  
Fig. 1124 Spare Base with Socket Assembly, Cat No. 1124 DP 99A.



**FIGS. 1273 & 1274 - CERTIFIED FOR USE ON POWER DRIVEN VESSELS UNDER 12 METERS (39.4 FT.) IN LENGTH**

**CONSTRUCTION:**

- \* "REDUCED GLARE" DESIGN
- \* BLACK PLASTIC TOP
- \* CHROME PLATED ZINC ALLOY MOUNTING BRACKET
- \* WATERPROOF COVER FOR BASE
- \* 3/4 INCH DIAMETER ANODIZED ALUMINUM TUBES
- \* STOW-A-WAY PLUG-IN TYPE
- \* PLASTIC ADAPTERS FOR FLAT OR "V" TYPE 45 DEGREE WINDSHIELDS



**FIG. 1273**



**FIG. 1274**

**ORDERING INFORMATION**



Vertical Height Inches	Dealer Pkg. - 5 Cards 1 Pc. per Card	OEM Bulk Pkg. 50 Pcs.	Screw Size	Ship Wt. Carton Lbs. DP/OEM Bulk
10-5/8	1273 DP1 CHR	1273 001 CHR	8	4.7/22.1
11-7/8	1274 DP1 CHR	1274 001 CHR	8	4.6/21.2
20	1273 DP2 CHR	1273 002 CHR	8	6.0/28.2
21-5/8	1274 DP2 CHR	1274 002 CHR	8	6.2/29.1

Spare Bulb (2 per card), Cat. No. 338 DP1 CLR. Fig. 1123 Spare Base with Socket Assembly, Cat No. 1123 DP 99A.  
Spare Lens Assembly, Cat. No. 240 DP LNS. Fig. 1124 Spare Base with Socket Assembly, Cat No. 1124 DP 99A.  
Spare Cap for Base, Cat No. 125 DP BLK.  
Spare Replacement Pole for Size No. 1, Cat. No.1273 DP1 99A  
Spare Replacement Pole for Size No. 2, Cat. No. 1273 DP2 99A

## COMBINATION MASTHEAD AND WHITE ALL-ROUND LIGHTS

CLEAR LENSES, TWO 12 VOLT BULBS INCLUDED

**FIG. 1125 - CERTIFIED FOR USE ON SAIL OR POWER DRIVEN VESSELS UNDER 20 METERS (65.6 FT.) IN LENGTH**



**CONSTRUCTION:**

- \* **DECK MOUNT**
- \* **BLACK PLASTIC AND CHROME PLATED ZINC ALLOY TOP**
- \* **CHROME PLATED BRASS BASE**
- \* **WATERPROOF COVER FOR BASE THAT ATTACHES TO DECK MOUNTED RETAINER WHEN LIGHT IS IN PLACE**
- \* **3/4 INCH DIAMETER ANODIZED ALUMINUM TUBE**
- \* **STOW-A-WAY PLUG-IN TYPE**



**Fig. 1125**



**ORDERING INFORMATION**

Vertical Height Inches	Dimensions Base Inches	Dealer Pkg. - 5 Cards 1 Pc. per Card	OEM Bulk Pkg. 50 Pcs.	Screw Size	Ship Wt. Carton Lbs. DP/OEM Bulk
33-7/8	3-3/8 x 2-1/4	1125 DP4 CHR	1125 004 CHR	8	7.6/40.9

Spare Bulb (2 per card), Cat. No. 71 DP CLR.  
Spare Lenses (2 per card), Cat. No. 278 DP WHT.  
Spare Top Cap with Screw, Cat. No. 1158 DP BLK.

Spare Cover for Base, Cat No. 125 DP BLK.  
Spare Base with Socket Assembly, Cat No. 1125 DP 99A.  
Spare Replacement Pole Light, Cat. No. 1125 DP4 99A.



## WHITE ALL-ROUND LIGHTS

12 VOLT BULBS INCLUDED

**FIG. 455 - CERTIFIED FOR USE ON POWER DRIVEN VESSELS UNDER 20 METERS (65.6 FT.) IN LENGTH**

**FIG. 466 - CERTIFIED FOR USE ON SAIL OR POWER DRIVEN VESSELS UNDER 20 METERS (65.6 FT.) IN LENGTH**



**CONSTRUCTION:**

- \* **FIG. 455 CLEAR FRESNEL GLOBE**
- \* **FIG. 466 FROSTED FRESNEL GLOBE**
- \* **BLACK PLASTIC BASE**
- \* **FIXED MOUNT**
- \* **SIZE #2 HAS 3/4 INCH ANODIZED ALUMINUM TUBES**



**Fig. 455 #1**

**Fig. 466 #2**



**ORDERING INFORMATION**

Vertical Height Inches	O.D. Base Inches	Dealer Pkg. - 5 Cards 1 Pc. per Card	OEM Bulk Pkg. 50 Pcs.	Screw Size	Ship Wt. Carton Lbs. DP/OEM Bulk
4-1/2	2-1/8	455 DP1 CHR	455 001 CHR	8	2.4/16.9
11-7/8	2-1/8	455 DP2 CHR	455 002 CHR	8	3.0/18.2
4-1/2	2-1/8	466 DP1 CHR*	466 001 CHR*	8	2.3/12.8
11-7/8	2-1/8	466 DP2 CHR*	466 002 CHR*	8	2.8/17.8

\* New Item  
Spare Bulb (2 per card), Cat. No. 337 011 DP.  
Fig. 455 Spare Globe, Cat. No. 248 DP CLR.  
Fig. 466 Spare Globe, Cat. No. 248 000 FRD.

Navigation Lights for Vessels Under 20 Meters

## WHITE ALL-ROUND POLE LIGHT & BASE COMBINATIONS

Navigation Lights for Vessels Under 20 Meters



### GLOBE STYLE



FIG. 239

The New Clear Globe allows for improved visibility when in rough water and from above. Advanced globe design reduces glare and helps preserve night vision.



For Specific Pole Light & Base Combination  
Ordering Information See Page 25

**FIGS. 1650/1655 - CERTIFIED FOR USE ON POWER DRIVEN VESSELS UNDER 20 METERS (65.6 FT.) IN LENGTH**

**CONSTRUCTION:**

- \* CONTEMPORARY STYLING
- \* BLACK PLASTIC, CLEAR FLUTED LENS AND FROSTED GLOBE
- \* 3/4 INCH DIAMETER ANODIZED TUBE WITH LOCKING COLLAR
- \* 12 VOLT BULB INCLUDED
- \* STOW-A-WAY PLUG-IN TYPE POLE
- \* WATER PROOF COVER FOR BASE

**FIG. 1650 - STRAIGHT TOP**

- \* BLACK PLASTIC AND CHROME PLATED BRASS BASE.

**FIG. 1655 - 5° ANGLED TOP**

- \* BLACK PLASTIC AND CHROME PLATED BRASS BASE
- \* THREADED COLLAR ON POLE

**FIG. 1651 - STRAIGHT TOP**

- \* BLACK SANTOPRENE CAP AND CHROME PLATED BRASS INSERT WITH BLACK PLASTIC MINI MOUNT BASE OR PLAIN BLACK SANTOPRENE CAP WITH BLACK PLASTIC MINI MOUNT BASE
- \* THREADED COLLAR ON POLE

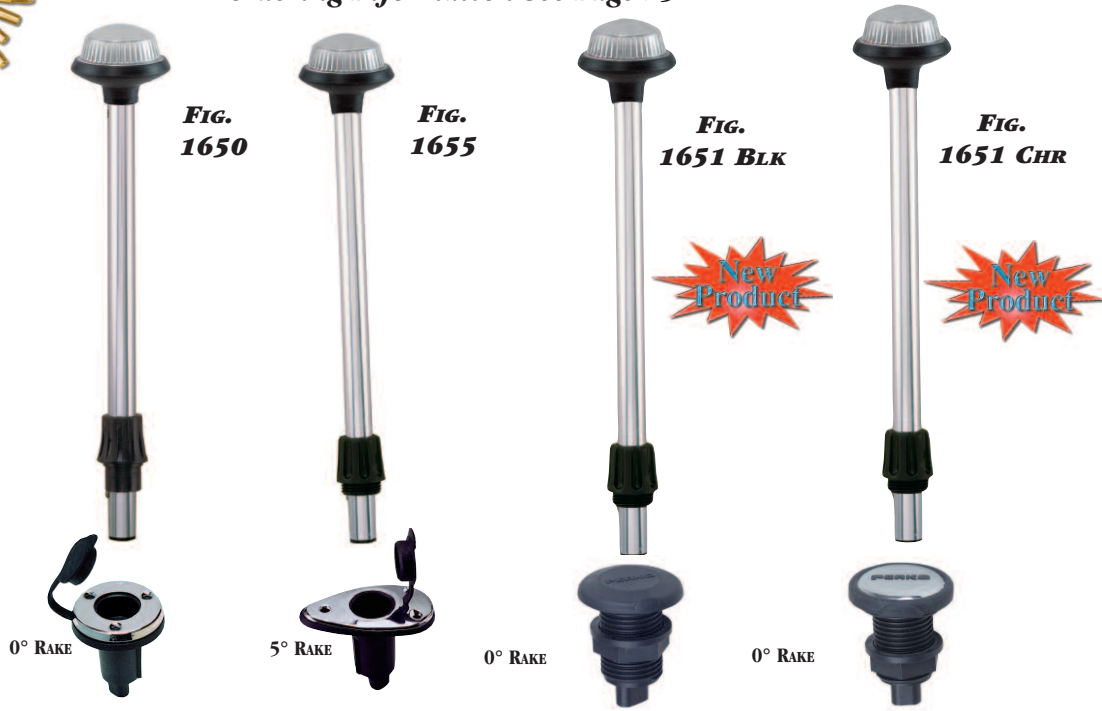

Replacement Base:	Fig. 1045	Fig. 1048	Fig. 1049 Blk	Fig. 1049 CHR
Replacement Pole:	Fig. 1460	Fig. 1655-99A	Fig. 1461	Fig. 1461

Fig. 30-DP-001

**SPARE PARTS FOR POLE LIGHTS ON THIS PAGE**

For Replacement Poles on this Page Except Fig 1651 & 1655, See Page 42.  
For Spare Bases with Socket Assemblies on this Page, See Page 43.  
Spare Bulbs For Lights on this Page (2 per card), Cat. No. 338 DP2 CLR.  
Spare Lens Assembly, Cat. No. 239 DP BLK.  
3 Globe Assortment has 1 ea. 238, 239 & 239 CLR Globes, Cat No. 30-DP-001.  
Replacement Pole for Fig. 1651 DP4 CHR, Cat. No. 1461 DP4 CHR.  
Replacement Pole for Fig. 1651 DP5 CHR, Cat. No. 1461 DP5 CHR.

Replacement Pole for Fig. 1651 DP6 CHR, Cat. No. 1461 DP6 CHR.  
Replacement Pole for Fig. 1651 DP7 CHR, Cat. No. 1461 DP7 CHR.  
Replacement Pole for Fig. 1655 DP4 CHR, Cat. No. 1655 DP4 99A.  
Replacement Pole for Fig. 1655 DP5 CHR, Cat. No. 1655 DP5 99A.  
Replacement Pole for Fig. 1655 DP6 CHR, Cat. No. 1655 DP6 99A.  
Replacement Pole for Fig. 1655 DP7 CHR, Cat. No. 1655 DP7 99A.



## WHITE ALL-ROUND POLE LIGHT & BASE COMBINATIONS

**CERTIFIED FOR USE ON POWER DRIVEN VESSELS UNDER  
20 METERS (65.6 FT.) IN LENGTH**



**CONSTRUCTION:**

- \* **“REDUCED GLARE DESIGN”**
- \* **CLEAR FLUTED GLOBE WITH BLACK PLASTIC TOP**
- \* **3/4 INCH DIAMETER ANODIZED TUBE WITH LOCKING COLLAR**
- \* **12 VOLT BULB INCLUDED**
- \* **STOW-A-WAY PLUG-IN TYPE POLE**
- \* **WATER RESISTANT SLIDE COVER OR WATER PROOF COVER FOR BASES.**

### GLOBE STYLE



Fig. 238

*The original “Reduced Glare” light. This design helps preserve night vision. In addition, since the amount of light wasted outside of the visibility zone is greatly reduced, this light does not attract as many bugs.*

**FIG. 1431 - 5° ANGLED TOP**

- \* **BLACK PLASTIC AND CHROME PLATED ZINC ALLOY BASE**

**FIG. 1621 - 5° ANGLED TOP**

- \* **BLACK PLASTIC AND CHROME PLATED BRASS BASE**
- \* **THREADED COLLAR ON POLE**

**FIG. 1632 - STRAIGHT TOP**

- \* **BLACK PLASTIC AND CHROME PLATED BRASS BASE**

**FIG. 1641 - 5° ANGLED TOP**

- \* **CHROME PLATED BRASS BASE WITH BLACK PLASTIC INSERT**

*For Specific Pole Light & Base Combination  
Ordering Information See Page 25*



5° RAKE



5° RAKE



5° RAKE



0° RAKE

Replacement Base: Fig. 1060

Replacement Pole: Fig. 1445

Fig. 1048

Fig. 1621-99A

Fig. 1046

Fig. 1445

Fig. 1045

Fig. 1440

Fig. 30-DP-001

**SPARE PARTS FOR POLE LIGHTS ON THIS PAGE**

For Replacement Poles on this Page Except Fig 1621, See Page 42

For Spare Bases with Socket Assemblies on this Page, See Page 43.

Spare Lens Assembly, Cat. No. 238 DP BLK.

Spare Bulbs For Lights on this Page (2 per card), Cat. No. 338 DP2 CLR.

3 Globe Assortment has 1 ea. 238, 239 & 239 CLR Globes, Cat No. 30-DP-001.

Fig 1621 Replacement Poles Size No. 4, Cat. No. 1621 DP4 99A.

Fig 1621 Replacement Poles Size No. 5, Cat. No. 1621 DP5 99A.

Fig 1621 Replacement Poles Size No. 6, Cat. No. 1621 DP6 99A.

Fig 1621 Replacement Poles Size No. 7, Cat. No. 1621 DP7 99A.



## WHITE ALL-ROUND POLE LIGHT & BASE COMBINATIONS

Navigation Lights for Vessels Under 20 Meters



### GLOBE STYLE



FIG. 201

Traditional frosted globe allows for all round visibility even when globe orientation is not horizontally aligned. In addition, this design also provides limited cockpit illumination



For Specific Pole Light & Base Combination  
Ordering Information See Page 25



**CERTIFIED FOR USE ON SAIL OR POWER DRIVEN VESSELS  
UNDER 20 METERS (65.6 FT.) IN LENGTH**

**CONSTRUCTION:**

- \* WHITE TRANSLUCENT GLOBE WITH BLACK PLASTIC TOP
- \* 3/4 INCH DIAMETER ANODIZED TUBE WITH LOCKING COLLAR
- \* WATER RESISTANT SLIDE COVER OR WATER PROOF COVER FOR BASES
- \* 12 VOLT BULB INCLUDED

**FIG. 1430 - STOW-A-WAY PLUG-IN TYPE**

- \* CHROME PLATED ZINC ALLOY BASE WITH BLACK PLASTIC INSERT

**FIG. 1630 - STOW-A-WAY PLUG-IN TYPE**

- \* CHROME PLATED ZINC ALLOY BASE

**FIGS. 1631, 1640 & 1660 - STOW-A-WAY PLUG-IN TYPE**

- \* BLACK PLASTIC AND CHROME PLATED BRASS BASE

**FIG. 1633 - STOW-A-WAY PLUG-IN TYPE**

- \* BLACK SANTOPRENE CAP AND CHROME PLATED BRASS INSERT WITH BLACK PLASTIC MINI MOUNT BASE OR PLAIN BLACK SANTOPRENE CAP WITH BLACK PLASTIC MINI MOUNT BASE
- \* THREADED COLLAR ON POLE



Replacement Base: Fig. 1059  
Replacement Pole: Fig. 1400

Fig. 1045  
Fig. 1400

Fig. 1047  
Fig. 1400

Fig. 1060  
Fig. 1400

Fig. 1046  
Fig. 1400

Fig. 1049 Blk  
Fig. 1401

Fig. 1049 Chr  
Fig. 1401

**SPARE PARTS FOR POLE LIGHTS ON THIS PAGE**

Replacement Poles for Fig 1633 DP4 CHR, Cat. No. 1401 DP4 CHR.  
Replacement Poles for Fig 1633 DP5 CHR, Cat. No. 1401 DP5 CHR.  
Replacement Poles for Fig 1633 DP6 CHR, Cat. No. 1401 DP6 CHR.  
Replacement Poles for Fig 1633 DP7 CHR, Cat. No. 1401 DP7 CHR.



For Replacement Poles on this Page, Except Fig 1633, See Page 41.  
Spare Bulbs For Lights on this Page (2 per card), Cat. No. 337 012 DP.  
Spare Globe, Cat. No. 201 DP WHT.  
For Spare Bases with Socket Assemblies on this Page, See Page 43.



## WHITE ALL-ROUND POLE LIGHT & BASE ORDERING INFORMATION



### ORDERING INFORMATION

Nominal Height Inches	239 Globe Style 		238 Globe Style 		201 Globe Style 		Approx. Ship Wt. Carton Lbs. DP/OEM Bulk
	Dealer Pkg. 5 Cards 1 Pc. per Card	OEM Bulk Pkg. 50 Pcs.	Dealer Pkg. 5 Cards 1 Pc. per Card	OEM Bulk Pkg. 50 Pcs.	Dealer Pkg. 5 Cards 1 Pc. per Card	OEM Bulk Pkg. 50 Pcs.	

**STOW-A-WAY PLUG-IN POLE LIGHT AND BASE COMBINATIONS FOR FIG. 1045 STYLE BASE (DIMENSIONS 2-1/4" O.D.) BLACK PLASTIC AND CHROME PLATED BRASS BASE WITH WATERPROOF SNAP-ON COVER. (SCREW SIZE #8)**

36	1650 DP4 CHR	1650 004 CHR	1632 DP4 CHR	1632 004 CHR	-----	-----	5.3/30.4
42	1650 DP5 CHR	1650 005 CHR	1632 DP5 CHR	1632 005 CHR	1631 DP5 CHR	1631 005 CHR	6.8/39.5
48	1650 DP6 CHR	1650 006 CHR	1632 DP6 CHR	1632 006 CHR	1631 DP6 CHR	1631 006 CHR	7.6/42.0
54	1650 DP7 CHR	1650 007 CHR	1632 DP7 CHR	1632 007 CHR	1631 DP7 CHR	1631 007 CHR	7.9/39.2



**FIG. 1045**  
0° RAKE

**STOW-A-WAY PLUG-IN POLE LIGHT AND BASE COMBINATIONS FOR FIG. 1046 STYLE BASE (DIMENSIONS 3-1/2" x 1-1/2") BLACK PLASTIC AND CHROME PLATED BRASS BASE WITH WATER RESISTANT SLIDE COVER. (SCREW SIZE #8)**

24	-----	-----	-----	-----	1640 DP2 CHR	1640 002 CHR	4.6/26.5
30	-----	-----	-----	-----	1640 DP3 CHR	1640 003 CHR	5.0/28.8
36	-----	-----	1641 DP4 CHR	1641 004 CHR	1640 DP4 CHR	1640 004 CHR	5.4/31.0
42	-----	-----	1641 DP5 CHR	1641 005 CHR	1640 DP5 CHR	1640 005 CHR	6.2/33.2
48	-----	-----	1641 DP6 CHR	1641 006 CHR	1640 DP6 CHR	1640 006 CHR	7.4/36.3
54	-----	-----	1641 DP7 CHR	1641 007 CHR	1640 DP7 CHR	1640 007 CHR	8.2/39.3



**FIG. 1046**  
5° RAKE

**STOW-A-WAY PLUG-IN POLE LIGHT AND BASE COMBINATIONS FOR FIG. 1047 STYLE BASE (DIMENSIONS 3-1/2" x 1-1/2") BLACK PLASTIC AND CHROME PLATED BRASS BASE WITH WATER RESISTANT SLIDE COVER (SCREW SIZE #8)**

42	-----	-----	-----	-----	1660 DP5 CHR	1660 005 CHR	6.9/39.7
48	-----	-----	-----	-----	1660 DP6 CHR	1660 006 CHR	7.7/44.3
54	-----	-----	-----	-----	1660 DP7 CHR	1660 007 CHR	8.0/39.3



**FIG. 1047**  
0° RAKE

**STOW-A-WAY PLUG-IN POLE LIGHT AND BASE COMBINATIONS FOR FIG. 1048 STYLE BASE (DIMENSIONS 3-1/2" x 2") BLACK PLASTIC AND CHROME PLATED BRASS BASE WITH WATERPROOF SNAP-ON COVER. (SCREW SIZE #8) FOR POLES WITH THEADED COLLARS.**

36	1655 DP4 CHR	1655 004 CHR	1621 DP4 CHR	1621 004 CHR	-----	-----	5.2/31.3
42	1655 DP5 CHR	1655 005 CHR	1621 DP5 CHR	1621 005 CHR	-----	-----	5.7/32.3
48	1655 DP6 CHR	1655 006 CHR	1621 DP6 CHR	1621 006 CHR	-----	-----	6.3/41.9
54	1655 DP7 CHR	1655 007 CHR	1621 DP7 CHR	1621 007 CHR	-----	-----	6.8/43.8



**FIG. 1048**  
5° RAKE

**STOW-A-WAY PLUG-IN POLE LIGHT AND BASE COMBINATIONS FOR FIG. 1059 STYLE BASE (DIMENSIONS 3-3/4" x 1-3/4") BLACK PLASTIC AND CHROME PLATED ZINC ALLOY BASE WITH WATERPROOF SNAP-ON COVER. (SCREW SIZE #8)**

24	-----	-----	-----	-----	1630 DP2 CHR	1630 002 CHR	5.6/27.1
30	-----	-----	-----	-----	1630 DP3 CHR	1630 003 CHR	6.4/31.3
36	-----	-----	-----	-----	1630 DP4 CHR	1630 004 CHR	6.6/32.3
42	-----	-----	-----	-----	1630 DP5 CHR	1630 005 CHR	7.7/34.2
48	-----	-----	-----	-----	1630 DP6 CHR	1630 006 CHR	8.0/36.7
54	-----	-----	-----	-----	1630 DP7 CHR	1630 007 CHR	8.1/46.5



**FIG. 1059**  
16° RAKE

**STOW-A-WAY PLUG-IN POLE LIGHT AND BASE COMBINATIONS FOR FIG. 1060 STYLE BASE (DIMENSIONS 3-3/4" x 1-3/4") BLACK PLASTIC AND CHROME PLATED ZINC ALLOY BASE WITH WATERPROOF SNAP-ON COVER. (SCREW SIZE #8)**

24	-----	-----	-----	-----	1430 DP2 CHR	1430 002 CHR	5.4/23.2
30	-----	-----	-----	-----	1430 DP3 CHR	1430 003 CHR	6.1/26.2
36	-----	-----	1431 DP4 CHR	1431 004 CHR	1430 DP4 CHR	1430 004 CHR	6.1/26.2
42	-----	-----	1431 DP5 CHR	1431 005 CHR	1430 DP5 CHR	1430 005 CHR	7.4/31.6
48	-----	-----	1431 DP6 CHR	1431 006 CHR	1430 DP6 CHR	1430 006 CHR	7.5/39.1
54	-----	-----	1430 DP7 CHR	1431 007 CHR	1430 DP7 CHR	1430 007 CHR	7.6/36.9



**FIG. 1060**  
5° RAKE

**STOW-A-WAY PLUG-IN POLE LIGHT AND BASE COMBINATIONS FOR FIG. 1049 MINI MOUNT STYLE BASE (DIMENSIONS 1-15/16 O.D.) PLAIN BLACK SANTOPRENE CAP WITH BLACK PLASTIC BASE. (REQUIRES NO SCREWS) FOR POLES WITH THEADED COLLARS.**

36	1651 DP4 BLK	1651 004 BLK	-----	-----	1633 DP4 BLK	1633 004 BLK	5.3/30.4
42	1651 DP5 BLK	1651 005 BLK	-----	-----	1633 DP5 BLK	1633 005 BLK	6.8/39.5
48	1651 DP6 BLK	1651 006 BLK	-----	-----	1633 DP6 BLK	1633 006 BLK	7.6/42.0
54	1651 DP7 BLK	1651 007 BLK	-----	-----	1633 DP7 BLK	1633 007 BLK	7.9/39.2



**FIG. 1049**  
w/BLK TOP  
BASE  
0° RAKE

**STOW-A-WAY PLUG-IN POLE LIGHT AND BASE COMBINATIONS FOR FIG. 1049 MINI MOUNT STYLE BASE (DIMENSIONS 1-15/16 O.D.) PLAIN BLACK SANTOPRENE CAP AND CHROME PLATED BRASS INSERT WITH BLACK PLASTIC BASE. (REQUIRES NO SCREWS) FOR POLES WITH THEADED COLLARS.**

36	1651 DP4 CHR	1651 004 CHR	-----	-----	1633 DP4 CHR	1633 004 CHR	5.3/30.4
42	1651 DP5 CHR	1651 005 CHR	-----	-----	1633 DP5 CHR	1633 005 CHR	6.8/39.5
48	1651 DP6 CHR	1651 006 CHR	-----	-----	1633 DP6 CHR	1633 006 CHR	7.6/42.0
54	1651 DP7 CHR	1651 007 CHR	-----	-----	1633 DP7 CHR	1633 007 CHR	7.9/39.2



**FIG. 1049**  
w/CHR TOP  
BASE  
0° RAKE

Navigation Lights for Vessels Under 20 Meters

## MINI-MOUNT BASE FOR WHITE ALL-ROUND POLE LIGHTS

Navigation Lights for Vessels Under 20 Meters



**FIG. 1633**  
**POLE & BASE**

**FIG. 1651**  
**POLE & BASE**

**FIG. 1049**  
**BASE ONLY**  
**WITH CHROME BRASS INSERT**



**FIG. 1049**  
**BASE ONLY**  
**WITH BLACK TOP**

*Mini-Mount Base Shown with tool for easy installation 1049 ITL 99A*

**NOTE: REQUIRES ACCESS FROM UNDERNEATH FOR INSTALLATION AND SERVICE**

**FIG. 1049 MINI MOUNT BASE FOR FIGS. 1651 & 1633 POLELIGHT AND BASE COMBINATIONS**

**CONSTRUCTION:**

- \* **BLACK REINFORCED PLASTIC BODY**
- \* **SANTOPRENE CAP TO SEAL OUT MOISTURE**
- \* **OPTIONAL CHROME PLATED BRASS DECORATIVE INSERT ON CAP**

**FEATURES:**

- \* **NO VISIBLE SCREW FASTENERS RESULTING IN A CLEAN APPEARANCE**
- \* **EXTREMELY SMALL FOOTPRINT (1-15/16 INCH DIA. MOUNTING FLANGE)**
- \* **ALLOWS LIGHT TO BE MOUNTED IN TIGHT PLACES**
- \* **SPECIAL TOOL AVAILABLE FOR EASY INSTALLATION**
- \* **ACCEPTS STANDARD THREADED SCREW COLLAR POLE LIGHTS**
- \* **CAP RESTS ON SANTOPRENE RIM WHEN OPEN, PREVENTING RATTLING OR DAMAGE TO GELCOAT**
- \* **LOW PROFILE CAP REDUCES LINE SNAGS**



**ORDERING INFORMATION**

Nominal Height Inches	Base Dimensions Inches	Dealer Pkg. 5 Cards 1 Pc. per Card	OEM Bulk Pkg. 50 Pcs.	Ship Wt. Carton Lbs. DP/OEM Bulk
<b>Fig. 201 Style Globe Plain Black Base</b>				
36	1-15/16 O.D.	1633 DP4 BLK	1633 004 BLK	5.3/30.4
42	1-15/16 O.D.	1633 DP5 BLK	1633 005 BLK	6.8/39.5
48	1-15/16 O.D.	1633 DP6 BLK	1633 006 BLK	7.6/42.0
54	1-15/16 O.D.	1633 DP7 BLK	1633 007 BLK	7.9/39.2
<b>Chrome Insert Base</b>				
36	1-15/16 O.D.	1633 DP4 CHR	1633 004 CHR	5.3/30.4
42	1-15/16 O.D.	1633 DP5 CHR	1633 005 CHR	6.8/39.5
48	1-15/16 O.D.	1633 DP7 CHR	1633 006 CHR	7.6/42.0
54	1-15/16 O.D.	1633 DP7 CHR	1633 007 CHR	7.9/39.2
<b>Fig. 239 Style Globe Plain Black Base</b>				
36	1-15/16 O.D.	1651 DP4 BLK	1651 004 BLK	5.3/30.4
42	1-15/16 O.D.	1651 DP5 BLK	1651 005 BLK	6.8/39.5
48	1-15/16 O.D.	1651 DP6 BLK	1651 006 BLK	7.6/42.0
54	1-15/16 O.D.	1651 DP7 BLK	1651 007 BLK	7.9/39.2
<b>Chrome Insert Base</b>				
36	1-15/16 O.D.	1651 DP4 CHR	1651 004 CHR	5.3/30.4
42	1-15/16 O.D.	1651 DP5 CHR	1651 005 CHR	6.8/39.5
48	1-15/16 O.D.	1651 DP7 CHR	1651 006 CHR	7.6/42.0
54	1-15/16 O.D.	1651 DP7 CHR	1651 007 CHR	7.9/39.2

**SPARE PARTS FOR POLE LIGHTS ON THIS PAGE**

- For Replacement Poles for Fig. 1633, See Page 24
- For Replacement Poles for Fig. 1651, See Page 22
- Spare Cap for Base, All Black Cat. No. 1049 DPB 99A
- Spare Cap for Base for Base, All Black w/ Chrome Insert Cat. No. 1049 DPC 99A
- Spare Bulbs For Fig. 1633 Lights (2 per card), Cat. No. 337 012 DP.
- Spare Lens Assembly For Fig. 1651, Cat. No. 239 DP BLK.
- Spare Globe for Fig. 1633, Cat. No. 201 DP WHT.
- Installation Tool, Cat. No. 1049 ITL 99A
- Spare Bulbs For Fig. 1651 Lights (2 per card), Cat. No. 338 DP2 CLR.

## WHITE ALL-ROUND POLE LIGHT & BASE COMBINATIONS

**CERTIFIED FOR USE ON POWER DRIVEN VESSELS UNDER  
20 METERS (65.6 FT.) IN LENGTH**



Navigation Lights for Vessels Under 20 Meters

### CONSTRUCTION:

- \* 3/4 INCH DIAMETER ANODIZED TUBE WITH LOCKING COLLAR
- \* WATER PROOF COVER FOR BASE
- \* 12 VOLT BULB INCLUDED

#### FIG. 1209 - STOW-A-WAY PLUG-IN TYPE

- \* CLEAR FRESNEL GLOBE
- \* CHROME PLATED BRASS TOP AND BASE
- \* WATERPROOF CAP AND RETAINER



#### FIG. 1311 - TELESCOPING TYPE

- \* CLEAR FRESNEL GLOBE
- \* BLACK PLASTIC TOP, CHROME PLATED ZINC ALLOY BASE

#### FIG. 1330 - STOW-A-WAY PLUG-IN TYPE

- \* CLEAR FRESNEL GLOBE
- \* BLACK PLASTIC TOP, CHROME PLATED ZINC ALLOY BASE

#### FIG. 1611- TELESCOPING TYPE

- \* WHITE TRANSLUCENT GLOBE WITH BLACK PLASTIC TOP
- \* CHROME PLATED ZINC ALLOY BASE



FIG. 1209



FIG. 1311



FIG. 1330



FIG. 1611



### ORDERING INFORMATION

Vertical Height Inches	Base Dimensions Inches	Dealer Pkg. 5 Cards 1 Pc. per Card	OEM Bulk Pkg. 50 Pcs.	Screw Size	Ship Wt. Carton Lbs. DP/OEM Bulk
<b>Fig. 1209</b>					
21-7/8	3-3/8 x 2-1/4	1209 DP2 CHR	1209 002 CHR	8	7.0/32.2
28-1/2	3-3/8 x 2-1/4	1209 DP3 CHR	1209 003 CHR	8	7.7/35.4
34-1/8	3-3/8 x 2-1/4	1209 DP4 CHR	1209 004 CHR	8	8.0/36.8
<b>Fig. 1311</b>					
20-1/8	3-3/4 x 1-5/8	1311 DP2 CHR	1311 002 CHR	8	5.3/28.7
26-5/8	3-3/4 x 1-5/8	1311 DP3 CHR	1311 003 CHR	8	6.4/29.4
32-3/8	3-3/4 x 1-5/8	1311 DP4 CHR	1311 004 CHR	8	6.4/29.4
<b>Fig. 1330</b>					
20-11-1/6	3-3/4 x 1-5/8	1330 DP2 CHR	1330 002 CHR	8	5.6/25.8
27-1/4	3-3/4 x 1-5/8	1330 DP3 CHR	1330 003 CHR	8	6.4/29.4
33	3-3/4 x 1-5/8	1330 DP4 CHR	1330 004 CHR	8	6.6/30.4
<b>Fig. 1611</b>					
20-1/4	3-3/4 x 1-5/8	1611 DP2 CHR	1611 002 CHR	8	5.1/27.3
26-1/2	3-3/4 x 1-5/8	1611 DP3 CHR	1611 003 CHR	8	6.1/32.9
32-3/8	3-3/4 x 1-5/8	1611 DP4 CHR	1611 004 CHR	8	6.3/34.0

Fig. 1209: Spare Bulb Socket, Cat. No. 24 DP2.

Fig. 1209: Spare Cap for Base, Cat. No. 125 DP BLK.

Spare Bulbs For Fig. 1611 (2 per card), Cat. No. 337 012 DP.

Spare Bulbs for Figs. 1209, 1311, & 1330, (2 per card), Cat. No. 337 011 DP.

Spare Globe for Figs. 1209, 1311, & 1330, Cat. No. 248 DP CLR.

Fig. 1209: Replacement Pole Size No. 2, Cat. No. 1209 DP2 99A.

Fig. 1209: Replacement Pole Size No. 3, Cat. No. 1209 DP3 99A.

Fig. 1209: Replacement Pole Size No. 4, Cat. No. 1209 DP4 99A.

Fig. 1330: Replacement Pole Size No. 2, Cat. No. 1330 DP2 99A.

Fig. 1330: Replacement Pole Size No. 3, Cat. No. 1330 DP3 99A.

Fig. 1330: Replacement Pole Size No. 4, Cat. No. 1330 DP4 99A.

Spare Globe Fig 1611, Cat. No. 201 DP WHT

Spare Bases & Socket Assemblies See Page 43.

## WHITE ALL-ROUND POLE LIGHTS

Navigation Lights for Vessels Under 20 Meters



**FIG. 1134**    **FIG. 1137**

**IMPROVED ADJUSTABILITY**

**FIGS. 1134/1137 - CERTIFIED FOR USE ON SAIL OR POWER DRIVEN VESSELS UNDER 20 METERS (65.6 FT.) IN LENGTH**

**CONSTRUCTION:**

- \* **WHITE TRANSLUCENT GLOBE**
- \* **BLACK PLASTIC BASE**
- \* **3/4 INCH DIAMETER ANODIZED ALUMINUM TUBE**
- \* **PLASTIC ADAPTERS FOR FLAT OR "V" TYPE MOUNT, CONTAINS NOTCH FOR THROUGH-BASE WIRING**
- \* **FOLD-DOWN, ADJUSTABLE ANGLE**
- \* **12 VOLT BULB INCLUDED**

**FIG. 1134 - HORIZONTAL MOUNT**  
**FIG. 1137 - VERTICAL MOUNT**



**ORDERING INFORMATION**

Vertical Height Inches	Dimensions Base Inches	Dealer Pkg. 5 Cards 1 Pc. per Card	OEM Bulk Pkg. 50 Pcs.	Screw Size	Ship Wt. Carton Lbs. DP/OEM Bulk
14	2 x 1-1/2	1134 DP CHR	1134 000 CHR	8	4.0/31.6
14	2-1/4 x 5/8	1137 DP CHR	1137 000 CHR	8	3.9/30.0

Spare Bulb (2 per card), Cat. No. 337 012 DP.  
Spare Globe, Cat. No. 201 DP WHT.  
Old Style Zinc Spare Bracket with Knob and End Plug for Fig. No. 1134, Cat. No. 1052 DP CHR.  
Old Style Zinc Spare Bracket with Knob and End Plug for Fig. No. 1137, Cat. No. 1054 DP CHR.  
New Style Plastic Spare Bracket with Knob and End Plug for Fig. No. 1134, Cat. No. 1052 DPB BLK.  
New Style Plastic Spare Bracket with Knob and End Plug for Fig. No. 1137, Cat. No. 1054 DPB BLK.



**FIG. 1634**    **FIG. 1637**

**IMPROVED ADJUSTABILITY**

**FIGS. 1634/1637 - CERTIFIED FOR USE ON POWER DRIVEN VESSELS UNDER 20 METERS (65.6 FT.) IN LENGTH**

**CONSTRUCTION:**

- \* **REDUCED GLARE DESIGN**
- \* **BLACK PLASTIC TOP WITH CLEAR FLUTED LENS & FROSTED GLOBE**
- \* **BLACK PLASTIC BASE**
- \* **3/4 INCH DIAMETER ANODIZED ALUMINUM TUBE**
- \* **PLASTIC ADAPTERS FOR FLAT OR "V" TYPE MOUNT, CONTAINS NOTCH FOR THROUGH-BASE WIRING**
- \* **12 VOLT BULBS INCLUDED**

**FIG. 1634 - HORIZONTAL MOUNT**  
**FIG. 1637 - VERTICAL MOUNT**



**ORDERING INFORMATION**

Vertical Height Inches	Dimensions Base Inches	Dealer Pkg. 5 Cards 1 Pc. per Card	OEM Bulk Pkg. 50 Pcs.	Screw Size	Ship Wt. Carton Lbs. DP/OEM Bulk
13-3/8	2 x 1-1/2	1634 DP CHR	1634 000 CHR	8	3.7/29.2
13-3/8	2-1/4 x 5/8	1637 DP CHR	1637 000 CHR	8	3.7/28.2

Spare Bulb (2 per card), Cat. No. 338 DP2 CLR.  
Spare Lens Assembly, Cat. No. 239 DP BLK.  
Old Style Zinc Spare Bracket with Knob and End Plug for Fig. No. 1634, Cat. No. 1052 DP CHR.  
Old Style Zinc Spare Bracket with Knob and End Plug for Fig. No. 1637, Cat. No. 1054 DP CHR.  
New Style Plastic Spare Bracket with Knob and End Plug for Fig. No. 1634, Cat. No. 1052 DPB BLK.  
New Style Plastic Spare Bracket with Knob and End Plug for Fig. No. 1637, Cat. No. 1054 DPB BLK.

## WHITE ALL-ROUND LIGHTS

**FIG. 1340 - CERTIFIED FOR USE ON POWER DRIVEN VESSELS UNDER 20 METERS (65.6 FT.) IN LENGTH**

**FIG. 1341 - CERTIFIED FOR USE ON SAIL DRIVEN VESSELS UNDER 20 METERS (65.6 FT.) IN LENGTH**

**CONSTRUCTION:**

**"REDUCED GLARE" DESIGN.**

- \* **WHITE PLASTIC TOP WITH CLEAR FLUTED LENS & FROSTED GLOBE**
- \* **FIXED MOUNT WHITE PLASTIC BASE**
- \* **3/4 INCH DIAMETER ANODIZED ALUMINUM TUBE**

**\* L.E.D. FEATURES**

- \* **USES LESS THAN HALF THE ENERGY DRAW OF STANDARD LIGHTS**
- \* **LOW HEAT**
- \* **LONG LIFE**



**L.E.D.'S**



**ORDERING INFORMATION**

Vertical Height Inches	Dimensions Base Inches	Dealer Pkg. 1 Pc. per Card	OEM Bulk Pkg. 1 Pcs.	Screw Size	Ship Wt. Carton Lbs. DP/OEM Bulk
7-1/8	1 x 2-5/8	1340 DP1 WHT	1340 001 WHT	8	0.6/0.6
7-7/8	1 x 2-5/8	1341 DP1 WHT	1341 001 WHT	8	0.6/0.6



12



**FIG. 1340  
POWERBOAT  
VERSION**



**FIG. 1341  
SAILBOAT  
VERSION**

Navigation Lights for Vessels Under 20 Meters

**FIG. 1604 - CERTIFIED FOR USE ON POWER DRIVEN VESSELS UNDER 20 METERS (65.6 FT.) IN LENGTH**

**CONSTRUCTION:**

**"REDUCED GLARE" DESIGN.**

- \* **BLACK PLASTIC TOP WITH CLEAR FLUTED LENS & FROSTED GLOBE**
- \* **FIXED MOUNT BLACK PLASTIC BASE**
- \* **3/4 INCH DIAMETER ANODIZED ALUMINUM TUBE**
- \* **12 VOLT BULB INCLUDED**



**ORDERING INFORMATION**

Vertical Height Inches	Dimensions Base Inches	Dealer Pkg. 5 Cards 1 Pc. per Card	OEM Bulk Pkg. 50 Pcs.	Screw Size	Ship Wt. Carton Lbs. DP/OEM Bulk
7-1/8	1 x 2-5/8	1604 DP CHR	1604 000 CHR	8	2.0/9.5

Spare Bulb For Fig. 1604 (2 per card), Cat. No. 338 DP2 CLR.  
Spare Lens Assembly For Fig. 1604, Cat. No. 239 DP BLK.



12



**FIG. 1604**

## WHITE ALL-ROUND LIGHTS

Navigation Lights for Vessels Under 20 Meters

**Figs. 120 SWB & 1301**



**Fig. 170 SWB**



**Figs. 120/170 SWB & 1301 - CERTIFIED FOR USE ON SAIL OR POWER DRIVEN VESSELS UNDER 20 METERS (65.6 FT.) IN LENGTH**

**CONSTRUCTION:**

- \* WHITE TRANSLUCENT GLOBE AND BLACK PLASTIC TOP
- \* FIXED MOUNT BLACK PLASTIC BASE
- \* 3/4 INCH DIAMETER ANODIZED ALUMINUM TUBE (FIG. 1301)

**Figs. 120 SWB & 1301 - 12 VOLT BULB INCLUDED**

**Fig. 170 SWB - 24 VOLT BULB INCLUDED**



**Figs. 120 SWB & 170 SWB**

**Fig. 1301**



**ORDERING INFORMATION**

Vertical Height Inches	Dimensions Base Inches	Dealer Pkg. 5 Cards 1 Pc. per Card	OEM Bulk Pkg. 50 Pcs.	Screw Size	Ship Wt. Carton Lbs. DP/OEM Bulk
3-7/8	1 x 2-5/8	120 SWB DP1	120 SWB 12V	8	1.9/10.0
3-7/8	1 x 2-5/8	170 SWB DP2	170 SWB 24V	8	1.9/10.0
7-1/8	1 x 2-5/8	1301 DP CHR	1301 000 CHR	8	2.2/11.6

Spare 12 Volt Bulbs For Figs. 120 SWB & 1301 (2 per card), Cat. No. 337 012 DP.

For Fig. 120/170 SWB Spare Globe, Cat. No. 201 DP WHT.

Spare 24 Volt Bulb For Fig. 170 SWB, (1 per card), Cat. No. 337 014 DP.

## POLE STORAGE CLIPS & GLARE SHIELD

**Fig. 477 - POLE STORAGE CLIPS**

**CONSTRUCTION**

- \* SOFT BLACK PLASTIC, U.V. STABILIZED
- \* FITS 3/4 INCH DIAMETER TUBING



**Fig. 477**

**Fig. 1192**



**ORDERING INFORMATION**

For Pole O.D. Inches	Dimensions Inches	Dealer Pkg. 10 Cards 1 Pair per Card	OEM Bulk Pkg. 50 Pair	Screw Size	Ship Wt. Carton Lbs. DP/OEM Bulk
3/4	3/4 x 2-1/4 x 1-5/8	477 DP BLK	477 000 BLK	10 P.H.	1.5/4.3

**Fig. 1192 - GLARE SHIELD**

**CONSTRUCTION:**

- \* BLACK PLASTIC
- \* FOR 3/4 INCH O.D. TUBING
- \* CAN BE INSTALLED WITHOUT REMOVING LIGHT



**ORDERING INFORMATION**

Dimensions Inches	Dealer Pkg. - 5 Cards 1 Pc. per Card	OEM Bulk Pkg. 25 Pcs.	Ship Wt. Carton Lbs. DP/OEM Bulk
6 x 4-5/16	1192 DP BLK	1192 000 BLK	1.5/3.1



## EUROPEAN STYLE L.E.D. NAVIGATION LIGHTS

**FIG. 170 SERIES L.E.D. - CERTIFIED FOR USE ON SAIL OR POWER DRIVEN VESSELS UNDER 20 METERS (65.6 FT.) IN LENGTH (12 OR 24 VOLT)**

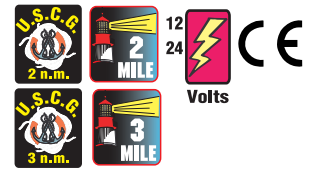

Navigation Lights for Vessels Under 20 Meters

**CONSTRUCTION OPTIONS:**

- \* **CHROME PLATED BRASS TOP WITH BLACK PLASTIC BASE**
- \* **ALL BLACK PLASTIC**
- \* **ALL WHITE PLASTIC**
- \* **12 VOLT OR 24 VOLT L.E.D.**

**L.E.D. FEATURES**

- \* **USES LESS THAN HALF THE ENERGY DRAW OF STANDARD LIGHTS**
- \* **LOW HEAT**
- \* **LONG LIFE**



# L.E.D.'s

Dimensions 170 Series L.E.D.'s

Ht. Overall Inches 3-5/8	Proj. Overall Inches 2-1/2	Width Inches 4-1/8	Screw Size 10
--------------------------------	----------------------------------	--------------------------	---------------------

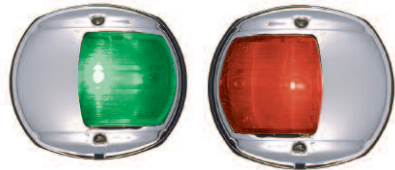

**FIG. 170 MSD    FIG. 170 MP**

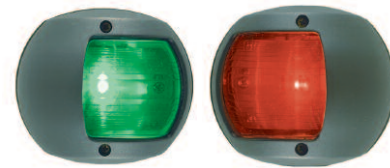

**FIG. 170 BSD    FIG. 170 BP**



**FIG. 170 WSD    FIG. 170 WP**



**FIG. 170 MSN    FIG. 170 MM**



**FIG. 170 BSN    FIG. 170 BM**



**FIG. 170 WSN    FIG. 170 WM**



### ORDERING INFORMATION - 170 L.E.D. SERIES 12 & 24 VOLT

Description	Visibility Arc	12 Volt		24 Volt		Visibility Miles	Ship Wt. Carton Lbs. Std Pkg/DP
		Dealer Pkg. 1 Card 1 Pc. per Card	Std. Pkg. 1 Pc.	Dealer Pkg. 1 Card 1 Pc. per Card	Std. Pkg. 1 Pc.		
<b>Black Plastic</b>							
Red Side Light	112-1/2°	170 BP DP3	170 BP 12L	170 BP DP4	170 BP 24L	2	0.5/0.6
Green Side Light	112-1/2°	170 BSD DP3	170 BSD 12L	170 BSD DP4	170 BSD 24L	2	0.5/0.6
White Masthead Lt	225°	170 BM DP3	170 BM 12L	170 BM DP4	170 BM 24L	3	0.5/0.6
White Stern Light	135°	170 BSN DP3	170 BSN 12L	170 BSN DP4	170 BSN 24L	2	0.5/0.6
<b>Chrome Plated Brass</b>							
Red Side Light	112-1/2°	170 MP DP3	170 MP 12L	170 MP DP4	170 MP 24L	2	0.6/0.7
Green Side Light	112-1/2°	170 MSD DP3	170 MSD 12L	170 MSD DP4	170 MSD 24L	2	0.6/0.7
White Masthead Lt	225°	170 MM DP3	170 MM 12L	170 MM DP4	170 MM 24L	3	0.6/0.7
White Stern Light	135°	170 MSN DP3	170 MSN 12L	170 MSN DP4	170 MSN 24L	2	0.6/0.7
<b>White Plastic</b>							
Red Side Light	112-1/2°	170 WP DP3	170 WP 12L	170 WP DP4	170 WP 24L	2	0.5/0.6
Green Side Light	112-1/2°	170 WSD DP3	170 WSD 12L	170 WSD DP4	170 WSD 24L	2	0.5/0.6
White Masthead Lt	225°	170 WM DP3	170 WM 12L	170 WM DP4	170 WM 24L	3	0.5/0.6
White Stern Light	135°	170 WSN DP3	170 WSN 12L	170 WSN DP4	170 WSN 24L	2	0.5/0.6

## EUROPEAN STYLE NAVIGATION LIGHTS

Navigation Lights for Vessels Under 20 Meters

**120 SERIES - CERTIFIED FOR USE ON SAIL OR POWER DRIVEN VESSELS UNDER 12 METERS (39.4 FT.) IN LENGTH (12 VOLT ONLY)**

**FIG. 170 - CERTIFIED FOR USE ON SAIL OR POWER DRIVEN VESSELS UNDER 20 METERS (65.6 FT.) IN LENGTH (12 OR 24 VOLT)**

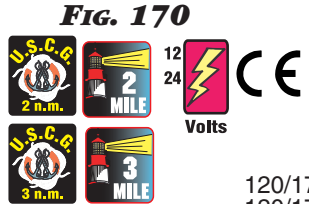
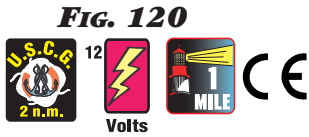

**CONSTRUCTION OPTIONS:**

- \* CHROME PLATED BRASS TOP WITH BLACK PLASTIC BASE
- \* ALL BLACK PLASTIC
- \* ALL WHITE PLASTIC
- \* 12 VOLT OR 24 VOLT BULB INCLUDED

	Ht. Overall Inches	Proj. Overall Inches	Width Inches	Screw Size	Ship Wt. Carton Lbs. Std Pkg/DP/OEM Bulk
120/170 Chrome Series	3-5/8	2-1/2	4-1/8	10	0.6/2.5/2.5
120/170 Black Plastic Series	3-5/8	2-1/2	4-1/8	10	0.5/2.3/2.3
120/170 White Plastic Series	3-5/8	2-1/2	4-1/8	10	0.5/2.3/2.3
120 & 170 BMD	7	4-3/4	4-1/8	10	0.9/5.4/5.4
120 SWB	5-1/8*	-----	2-1/2	8	--/1.9/10.0
170 SWB	5-1/8*	-----	2-1/2	8	--/1.9/10.0

\*Vertical Height - 3-3/4 Inches.

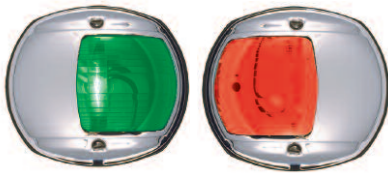

**FIG. 120 MSD 170 MSD**     **FIG. 120 MP 170 MP**



**FIG. 120 BSD 170 BSD**     **FIG. 120 BP 170 BP**

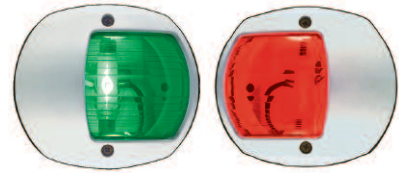

**FIG. 120 WSD 170 WSD**     **FIG. 120 WP 170 WP**



**FIG. 120 MB 170 MB**



**FIG. 120 BB 170 BB**

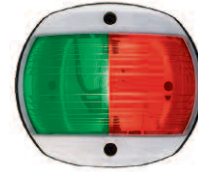

**FIG. 120 WB 170 WB**



**FIG. 120 MSN 170 MSN**     **FIG. 120 MM 170 MM**

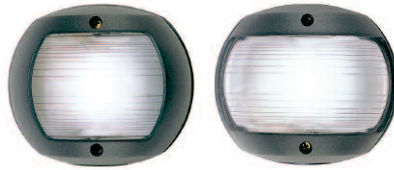

**FIG. 120 BSN 170 BSN**     **FIG. 120 BM 170 BM**

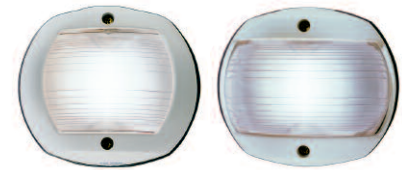

**FIG. 120 WSN 170 WSN**     **FIG. 120 WM 170 WM**



**FIG. 120 SWB & 170 SWB**



**FIG. 120 BMD & 170 BMD**

**170 BMD 12 VOLT ONLY**

**SPARE PARTS ORDERING INFORMATION**

Spare Halogen Bulb for Deck Spreader Light, Cat. No. 68 12V 20W.  
 Spare Bulbs (2 per card) for 120 SWB, Cat. No. 337 012 DP.  
 Spare Bulb for 170 SWB, (1 per card) (24 Volt), Cat. No. 337 014 DP.  
 Spare Bulbs (2 per card) for All Other 120's, Cat. No. 69 DP CLR.  
 Spare Bulbs (2 per card) for 170 BSN, MSN & WSN (24 Volt), Cat. No. 67 DP1 CLR.  
 Spare Bulbs (2 per card) for 170 BSN, MSN & WSN (12 Volt), Cat. No. 69 DP CLR.  
 Spare Bulbs (2 per card) for All Other 12 Volt 170's, Cat. No. 70 DP1 CLR.  
 Spare Bulbs (2 per card) for All Other 24 Volt 170's, Cat. No. 67 DP2 CLR.  
 For Spare Lens and Shield Assembly, Replace the Last Three Digits of the Catalog Number with the Letters "LNS" (e.g., 120 BB LNS, for a Black Shield and Bi-Color Lens).



## EUROPEAN STYLE NAVIGATION LIGHTS

### 120 SERIES & 170 SERIES LIGHTS



#### ORDERING INFORMATION - 120 SERIES 12 VOLT

Description	Visibility Arc	Dealer Pkg. - 5 Cards 1 Pc. per Card	OEM Bulk Pkg. 5 Pcs.	Visibility Miles
<b>Black Plastic</b>				
Bi-Color Light	225°	120 BB DP1	120 BB 12V*	1
Red Side Light	112-1/2°	120 BP DP1	120 BP 12V*	1
Green Side Light	112-1/2°	120 BSD DP1	120 BSD 12V	1
White Masthead Light	225°	120 BM DP1	120 BM 12V*	2
White Stern Light	135°	120 BSN DP1	120 BSN 12V*	2
<b>Chrome Plated Brass</b>				
Bi-Color Light	225°	120 MB DP1	120 MB 12V*	1
Red Side Light	112-1/2°	120 MP DP1	120 MP 12V	1
Green Side Light	112-1/2°	120 MSD DP1	120 MSD 12V	1
White Masthead Light	225°	120 MM DP1	120 MM 12V*	2
White Stern Light	135°	120 MSN DP1	120 MSN 12V*	2
<b>White Plastic</b>				
Bi-Color Light	225°	120 WB DP1	120 WB 12V*	1
Red Side Light	112-1/2°	120 WP DP1	120 WP 12V	1
Green Side Light	112-1/2°	120 WSD DP1	120 WSD 12V	1
White Masthead Light	225°	120 WM DP1	120 WM 12V	2
White Stern Light	135°	120 WSN DP1	120 WSN 12V	2
<b>Masthead/Deck Spreader Light</b>	225°	120 BMD DP1	120 BMD 12V*	2
<b>White All-Round Light</b>	360°	120 SWB DP1	120 SWB 12V***	2

Navigation Lights for Vessels Under 20 Meters



#### ORDERING INFORMATION - 170 SERIES 12 & 24 VOLT

Description	Visibility Arc	12 Volt		24 Volt		Visibility Miles
		Dealer Pkg. - 5 Cards 1 Pc. per Card	OEM Bulk Pkg. 5 Pcs	Dealer Pkg. - 5 Cards 1 Pc. per Card	Std. Pkg. 1 Pc.	
<b>Black Plastic</b>						
Bi-Color Light	225°	170 BB DP1	170 BB 12V*	170 BB DP2	170 BB 24V	2
Red Side Light	112-1/2°	170 BP DP1	170 BP 12V	170 BP DP2	170 BP 24V	2
Green Side Light	112-1/2°	170 BSD DP1	170 BSD 12V	170 BSD DP2	170 BSD 24V	2
White Masthead Light	225°	170 BM DP1	170 BM 12V*	170 BM DP2	170 BM 24V	3
White Stern Light	135°	170 BSN DP1	170 BSN 12V*	170 BSN DP2	170 BSN 24V	2
<b>Chrome Plated Brass</b>						
Bi-Color Light	225°	170 MB DP1	170 MB 12V*	170 MB DP2	170 MB 24V	2
Red Side Light	112-1/2°	170 MP DP1	170 MP 12V	170 MP DP2	170 MP 24V	2
Green Side Light	112-1/2°	170 MSD DP1	170 MSD 12V	170 MSD DP2	170 MSD 24V	2
White Masthead Light	225°	170 MM DP1	170 MM 12V	170 MM DP2	170 MM 24V	3
White Stern Light	135°	170 MSN DP1	170 MSN 12V	170 MSN DP2	170 MSN 24V	2
<b>White Plastic</b>						
Bi-Color Light	225°	170 WB DP1	170 WB 12V	170 WB DP2	170 WB 24V	2
Red Side Light	112-1/2°	170 WP DP1	170 WP 12V	170 WP DP2	170 WP 24V	2
Green Side Light	112-1/2°	170 WSD DP1	170 WSD 12V	170 WSD DP2	170 WSD 24V	2
White Masthead Light	225°	170 WM DP1	170 WM 12V*	170 WM DP2	170 WM 24V	3
White Stern Light	135°	170 WSN DP1	170 WSN 12V*	170 WSN DP2	170 WSN 24V	2
<b>White All-Round Light</b>	360°	(See 120 SWB Above)	(See 120 SWB Above)	170 SWB DP2	-----	2
<b>Mast/Dk Spreader Lt</b>	225°	170 BMD DP1	-----	-----	-----	3

\* Available Std Pkg 1 Pc Only.

\*\*\* OEM Bulk Pkg. - 50 pcs.

## EUROPEAN STYLE NAVIGATION LIGHTS

Navigation Lights for Vessels Under 20 Meters

**200 SERIES - CERTIFIED FOR USE ON SAIL OR POWER DRIVEN VESSELS UNDER 20 METERS (65.6 FT.) IN LENGTH**

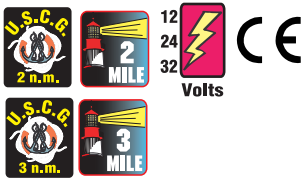

**CONSTRUCTION OPTIONS:**

\* **12, 24 OR 32 VOLT BULB INCLUDED**

**TOP MOUNT**

\* **BLACK PLASTIC WITH STAINLESS STEEL MOUNTING BRACKET**

**BASE MOUNT**

\* **BLACK PLASTIC**

**HALYARD MOUNT**

\* **BLACK PLASTIC WITH STAINLESS STEEL MOUNTING HARDWARE**

	Height Overall Inches	Projection Inches	O.D. Base Inches	Height Lens Inches	Screw Size
Top Mount	4-13/16	3-5/16	-----	2-3/4	8
Base Mount	4-7/8	-----	3-5/16	2-3/4	10
Halyard	7-1/8	-----	3-5/16	2-3/4	----
Double Base Mount	8-5/8	-----	3-5/16	2-3/4	10

**FIG. 200 SERIES TOP MOUNT**



**FIG. 200 SDT**

**FIG. 200 PT**



**FIG. 200 MT**

**FIG. 200 BT**



**FIG. 200 SNT**

**FIG. 200 TWT**

**FIG. 200 SERIES DOUBLE STACK BASE MOUNT**



**FIG. 200 TAB**   **FIG. 200 GRB**

**FIG. 200 SERIES HALYARD MOUNT**



**FIG. 200 SRH**

**FIG. 200 SERIES BASE MOUNT**



**FIG. 200 SGB**

**FIG. 200 SRB**



**FIG. 200 MB**

**FIG. 200 BB**



**FIG. 200 SNB**

**FIG. 200 TWB**

**SPARE PARTS ORDERING INFORMATION**

Spare Lens Assembly Part Numbers are Determined by Replacing the Last Three Digits of the Catalog Number with the Letters "LNS" (example: 200 BT LNS, for a Bi-Color Top Mount Lens Assembly).

Spare Replacement Bulb Sockets: (single and lower for double) Cat. No. 93, (upper for double), Cat No. 95.

## EUROPEAN STYLE NAVIGATION LIGHTS

Navigation Lights for Vessels Under 20 Meters

### 200 SERIES TOP MOUNT, BASE MOUNT, HALYARD MOUNT & DOUBLE STACK BASE MOUNT



#### ORDERING INFORMATION - FOR 12 VOLT LIGHTS

Description	Visibility Arc	Dealer Pkg. - 5 Cards 1 Pc. per Card	Visibility Miles	Replacement Bulb	Ship Wt. Carton Lbs. Dealer Package
<b><u>TOP MOUNT</u></b>					
Bi-Color Light	225°	200 BT DP1	2	375 12V 25W	4.3
Red Side Light	112-1/2°	200 PT DP1	2	375 12V 25W	4.5
Green Side Light	112-1/2°	200 SDT DP1	2	375 12V 25W	4.5
White Masthead Light	225°	200 MT DP1	3	375 12V 25W	4.3
White Stern Light	135°	200 SNT DP1	2	375 12V 10W	4.5
Yellow Towing Light	135°	200 TWT DP1	2	375 12V 10W	4.5
<b><u>BASE MOUNT</u></b>					
Bi-Color Light	225°	200 BB DP1	2	375 12V 25W	4.0
Red Side Light	112-1/2°	200 PB DP1	2	375 12V 25W	4.2
Green Side Light	112-1/2°	200 SDB DP1	2	375 12V 25W	4.2
White Masthead Light	225°	200 MB DP1	3	375 12V 25W	4.0
White Stern Light	135°	200 SNB DP1	2	375 12V 10W	4.2
Yellow Towing Light	135°	200 TWB DP1	2	375 12V 10W	4.0
White All-Round Light	360°	200 SWB DP1	2	375 12V 10W	3.8
Red All-Round Light	360°	200 SRB DP1	2	375 12V 25W	3.8
Green All-Round Light	360°	200 SGB DP1	2	375 12V 25W	3.8
Tri-Color Light*	360°	200 TB DP1	2	375 12V 25W	3.8
<b><u>HALYARD MOUNT</u></b>					
White All-Round Light	----	200 SWH DP1	2	375 12V 10W	5.0
Red All-Round Light	----	200 SRH DP1	2	375 12V 25W	5.0
Green All-Round Light	----	200 SGH DP1	2	375 12V 25W	5.0
<b><u>DOUBLE STACK BASE MOUNT</u></b>					
Tri-Color/White All-Round Light*	----	200 TAB DP1	2/2	375 12V 25W/10W	6.1
Masthead/White All-Round Light	----	200 MAB DP1	3/2	375 12V 25W/10W	6.2
Green/Red All-Round Light	----	200 GRB DP1	2/2	375 12V 25W/25W	6.0

\* For Use on Vessels Under Sail Alone.

#### ORDERING INFORMATION - FOR 24V LIGHTS

Replace the "DP1" with "DP2".  
For the Replacement Bulb,  
Replace the "12V" with "24V" (e.g., 375 24V 25W).

#### ORDERING INFORMATION - FOR 32V LIGHTS

Replace the "DP1" with "DP3".  
For the Replacement Bulb,  
Replace the "12V" with "32V" (e.g., 375 32V 25W).

#### FIG. 222 - PIPE MOUNTING BRACKET - FOR USE ON ALL 200 SERIES BASE MOUNT LIGHTS

##### CONSTRUCTION:

\* **BLACK PLASTIC**

\* **INCLUDES SCREWS AND SOFT BLACK MOUNTING GASKET FOR MOUNTING BRACKET TO LIGHT**



#### ORDERING INFORMATION

O.D. Overall Inches	Tapped Pipe Size Inches	Dealer Pkg. - 5 bags 1 Pc. per bag
3-5/16	1/2	222 DP BLK

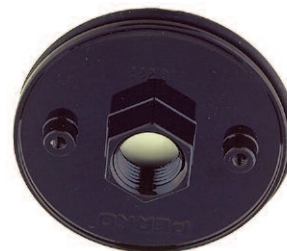
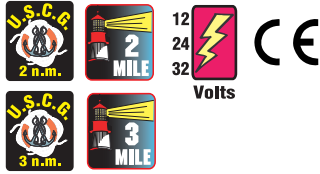

Fig. 222



## NAVIGATION LIGHTS

Navigation Lights for Vessels Under 20 Meters



**FIG. 108 - CERTIFIED FOR USE ON POWER DRIVEN VESSELS UNDER 20 METERS (65.6 FT.) IN LENGTH**  
**FIGS. 109, 110 & 111 - CERTIFIED FOR USE ON SAIL OR POWER DRIVEN VESSELS UNDER 20 METERS (65.6 FT.) IN LENGTH**

**CONSTRUCTION:**

- \* **BLACK PLASTIC**
- \* **FOR 12, 24 OR 32 VOLTS, BULB NOT INCLUDED**

Fig.	Ht. Overall Inches	Ht. Lens Inches	Tapped Pipe Size	Screw Size
108	6	5	1/2*	10
All Others	5-1/4	4-1/4	----	10

**ORDERING INFORMATION**

Description	Visibility Arc	Black Plastic Std Pkg. - 1 Pc.	Visibility Miles	Ship Wt. Carton Lbs. Std. Pkg
Red Side Light	112-1/2°	109 R00 BLK	2	1.0
Green Side Light	112-1/2°	109 G00 BLK	2	1.0
White Masthead Light	225°	110 000 BLK	3	1.0
White Stern Light	135°	111 000 BLK	2	1.0
Yellow Towing Light	135°	111 M00 BLK	2	1.0
White All-Round Light**	360°	108 000 BLK	2	1.0
Red All-Round Light	360°	108 R00 BLK	2	1.0
Green All-Round Light	360°	108 G00 BLK	2	1.0

\*Base Removable for Flush Mounting.  
 \*\*This Light is Supplied with a Gray Tinted Globe.



**FIG. 109**



**FIG. 110**



**FIG. 108**



**FIG. 111**



**FIG. 109**

**SPARE PARTS ORDERING INFORMATION**

**Spare Lenses:**  
 112-1/2° Fig. No. 259 H02, Specify Color.  
 135° Fig. No. 269 H02, Specify Color.  
 225° Cat. No. 256 H02 WHT.  
 360° Fig. No. 106 000, Specify Color.

**Required Bulbs:**  
 For 12 Volts (2 per card), Cat. No. 70 DP1 CLR.  
 For 24 Volts (2 per card), Cat. No. 67 DP2 CLR.  
 For 32 Volts (2 per card), Cat. No. 70 DP2 CLR.  
 Spare Base and Gasket for Fig. No. 108, Cat. No. 222 DP BLK.

**FIG. 329 - MEAL AND ABSENT LIGHT**

**CONSTRUCTION:**

- \* **CHROME PLATED BRONZE WITH BLUE & WHITE PLASTIC LENSES**
- \* **FOR 12 OR 32 VOLT, BULBS NOT INCLUDED**
- \* **DOUBLE CONTACT BAYONET SOCKETS**
- \* **BLUE OWNER ABSENT LIGHT AND WHITE MEALTIME LIGHT**
- \* **REPLACES BLUE AND WHITE FLAGS FOR USE AT NIGHT**
- \* **FOR MOUNTING ON MAIN STARBOARD YARDARM**



**FIG. 329**

**ORDERING INFORMATION**

Dimensions Base Inches	Length Overall Inches	O.D. Globe Inches	Standard Pkg. - 1 pc.	Screw Size	Ship Wt. Carton Lbs. Std. Pkg.
3-3/8 x 1-3/4	9	2-1/2	329 000 CHR	8	2.8

**SPARE PARTS ORDERING INFORMATION**

Required Bulbs (2 per card) For 12 Volt Use, Cat. No. 337 011 DP.  
 Required Bulbs (1 per card) For 32 Volt Use, Cat. No. 337 018 DP.  
 Spare Socket, Cat. No. 24 DP1.  
 Spare Blue Globe, Cat. No. 250 000 BLU.  
 Spare White Globe, Cat. No. 250 000 WHT.

## NAVIGATION LIGHTS

**CERTIFIED FOR REPLACEMENT USE ON POWER DRIVEN VESSELS  
UNDER 20 METERS (65.6 Ft.) IN LENGTH**

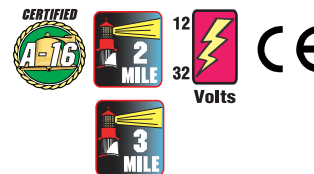

Navigation Lights for Vessels Under 20 Meters

### CONSTRUCTION:

- \* GALVANIZED STEEL SHEET METAL OR POLISHED BRASS
- \* BOTTOM OPENING, COMPLETE WITH MOUNTING BRACKET
- \* FOR 12 OR 32 VOLTS, BULB NOT INCLUDED

Height Overall Inches	Height Lens Inches	Screw Size
8-1/2	5-1/8	10

### ORDERING INFORMATION

Description	Visibility Arc	Galvanized Steel	Polished Brass	Visibility Miles	Ship Wt. Carton Lbs. Standard Pkg.
Side Lights (Pair)	112-1/2°	4 F03 GAL	4 F03 POL	2	5.4
Red Side Light	112-1/2°	4 RF3 GAL	4 RF3 POL	2	2.7
Green Side Light	112-1/2°	4 GF3 GAL	4 GF3 POL	2	2.7
White Masthead Light	225°	5 F03 GAL	5 F03 POL	3	2.9
White Stern Light	135°	7 F03 GAL	7 F03 POL	2	2.8
Yellow Towing Light	135°	7 MF3 GAL	7 MF3 POL	2	2.8



**FIG. 7F**



**FIG. 7MF**



**FIG. 5F**



**FIG. 4F**

### SPARE PARTS ORDERING INFORMATION

#### Spare Lenses:

112-1/2° Fig. No. 259 CL3, Specify Color.  
135° Fig. No. 269 CL3, Specify Color.  
225° Cat. No. 256 CL3 WHT.

Spare Mounting Bracket, Cat. No. 131 000 GAL or PLB.

Spare Electric Adapter, Cat. No. 290 F03.

#### Required Bulbs:

Bulbs (12 volts-2 per card), Cat. No. 70 DP1 CLR.  
Bulbs (32 volts-2 per card), Cat. No. 70 DP2 CLR.

## NAVIGATION LIGHT VERTICAL HEIGHTS

Navigation Lights for Vessels Under 20 Meters

NOTE: Vertical Height "H" is Measured from the Center of the Bulb Filament to the Mounting Surface and May be Used as a Generalized Guide for the Selection of Lights in Accordance with the '72 COLREGS and the 1 Meter Vertical Light Separation Requirements of Navigation Regulations.

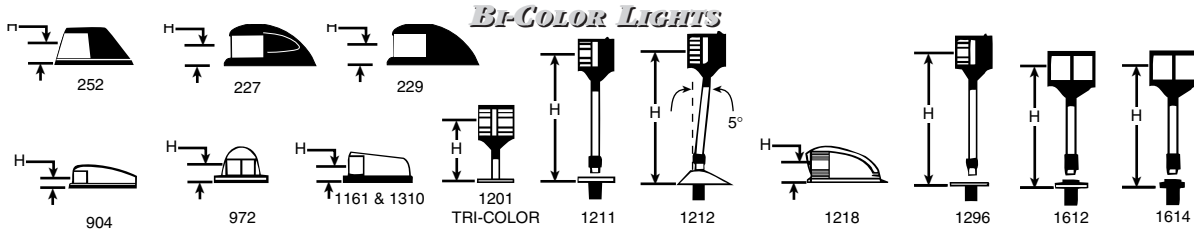

### Bi-COLOR LIGHTS

FIG.	227	229	252	904	972	1161	1201	1211	1212	1218	1296	1310	1612	1614
H	5/8	1	13/16	7/8	7/8	1	3-1/4	10	10-7/16	1-5/8	10	1	9-3/4	9-3/4

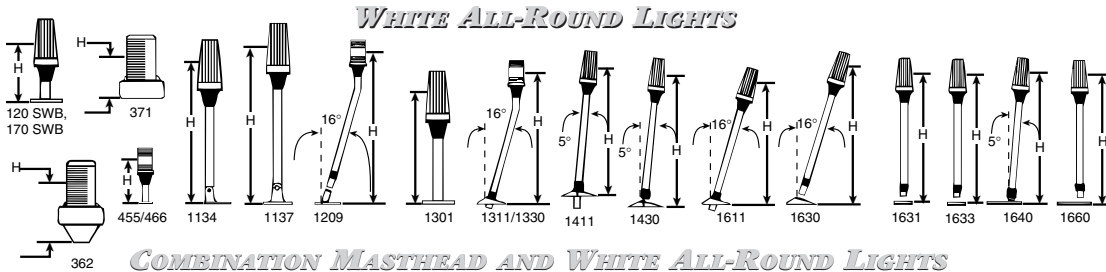

### WHITE ALL-ROUND LIGHTS

### COMBINATION MASTHEAD AND WHITE ALL-ROUND LIGHTS

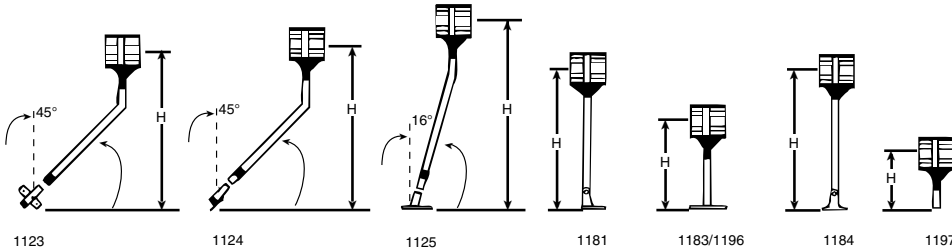

### DIMENSIONS

SIZE	1	2	3	4	5	6	7
FIG.	H	H	H	H	H	H	H
<b>WHITE ALL-ROUND LIGHTS</b>							
120 SWB	3-7/8						
170 SWB	3-7/8						
362	1-1/2						
371	1-1/2						
455		4-1/2	11-7/8				
466		4-1/2	11-7/8				
1134	14						
1137	14						
1209			21-7/8	28-1/2	34-1/8		
1301	7-1/8						
1311			20-1/8	26-5/8	32-3/8		
1330			20-11/16	27-1/4	33		
1411			22	27-5/8	33-5/8		
1430			22	27-5/8	33-5/8	41	46-7/8
1611			20-1/4	26-1/2	32-3/8		
1630			21-5/8	27-1/4	33	40-1/8	45-7/8
1631						40-3/4	46-7/8
1633						33-1/4	40-3/4
1640			21-5/8	27-1/4	33-1/4	40-5/8	46-1/2
1660						40-5/8	46-7/8
<b>COMBINATION MASTHEAD AND WHITE ALL-ROUND LIGHTS</b>							
1123			11-1/4	20-1/2			
1124			12-1/2	22			
1125					33-7/8		
1181	12-13/16						
1183	3-3/16						
1184	12-13/16						
1196		5-1/16	11-1/4				
1197	4						

### SIDE LIGHTS

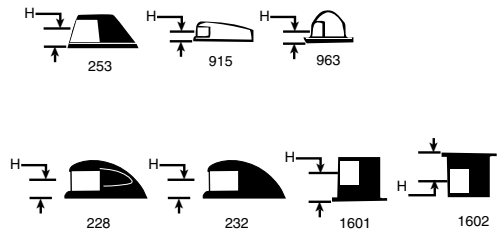

### SIDE LIGHTS

FIG.	228	232	253	915	963	1601	1602
H	5/8	1	13/16	7/8	7/8	1-1/4	1-1/4

### MASTHEAD LIGHTS

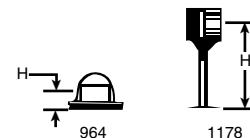

### MASTHEAD LIGHTS

FIG.	964	1178
H	7/8	3-1/4

## NAVIGATION LIGHT VERTICAL HEIGHTS

Navigation Lights for Vessels Under 20 Meters

NOTE: Vertical Height "H" is Measured from the Center of the Bulb Filament to the Mounting Surface and May be Used as a Generalized Guide for the Selection of Lights in Accordance with the '72 COLREGS and the 1 Meter Vertical Light Separation Requirements of Navigation Regulations.

### "REDUCED GLARE" DESIGN BI-COLOR LIGHTS

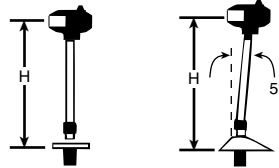

<b>"REDUCED GLARE" DESIGN BI-COLOR LIGHTS</b>			
FIG.	1421	1422	
H	9-9/16	9-7/8	

### "REDUCED GLARE" DESIGN WHITE ALL-ROUND LIGHTS

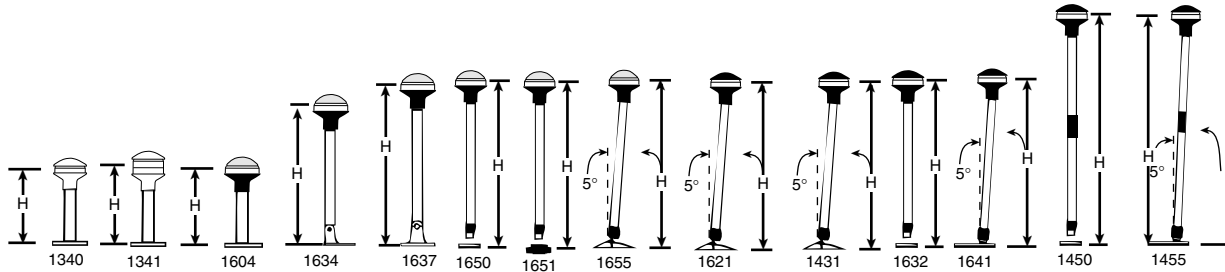

### "REDUCED GLARE" DESIGN COMBINATION MASTHEAD AND WHITE ALL-ROUND LIGHTS

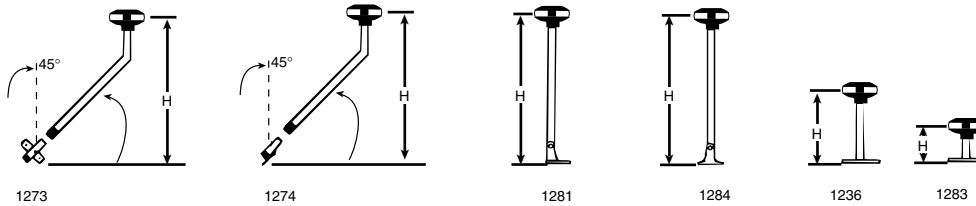

<b>DIMENSIONS</b>								
SIZE		1	2	3	4	5	6	7
FIG.	H	H	H	H	H	H	H	H
<b>"REDUCED GLARE" DESIGN WHITE ALL-ROUND LIGHTS</b>								
1340	7-1/8							
1341	7-7/8							
1431					33-3/16	40-11/16	46-1/4	51-7/16
1450								52-1/4
1455								52-1/4
1604	7-1/8							
1621					33-1/16	40-5/8	46-3/8	51-5/16
1634	13-3/8							
1632					33	40-5/8	46-3/8	51-7/16
1637	13-1/2							
1641					32-3/4	40-5/16	46-7/16	51-1/4
1650					33	40-5/8	46-3/8	51-3/8
1651					33	40-5/8	46-3/8	51-3/8
1655					33-1/16	40-5/8	46-3/8	51-5/16
<b>"REDUCED GLARE" DESIGN COMBINATION MASTHEAD AND WHITE ALL-ROUND LIGHTS</b>								
1236		4-1/2	11					
1273			10-5/8	20				
1274			11-7/8	21-5/8				
1281	12-3/16							
1283	2-1/4							
1284	12-3/16							

## ALL-ROUND LIGHTS

Navigation Lights for Vessels Under 20 Meters



**Fig. 108**

**FIG. 108 - CERTIFIED FOR USE ON POWER DRIVEN VESSELS UNDER 20 METERS (65.6 FT.) IN LENGTH**

**CONSTRUCTION:**

- \* **BLACK PLASTIC WITH FESTOON TYPE ELECTRICAL SOCKET**
- \* **FOR 12, 24 OR 32 VOLTS, BULB NOT INCLUDED**

**ORDERING INFORMATION**

Description	Height Overall Inches	O.D. Base Inches	Tapped Pipe Size Inches	Black Plastic Standard Pkg. - 1 Pc.	Screw Size	Ship Wt. Carton Lbs. Std. Pkg.
White All-Round	6	3-1/8	1/2*	108 000 BLK**	10	1.0
Red All-Round	6	3-1/8	1/2*	108 R00 BLK	10	1.0
Green All-Round	6	3-1/8	1/2*	108 G00 BLK	10	1.0

\*Base Removable for Surface Mounting.  
 \*\*This Light is Supplied with a Gray Tinted Globe.



**Fig. 112-B**



**Fig. 309-B**

**FIGS. 112 & 309 - CERTIFIED FOR REPLACEMENT USE ONLY ON POWER DRIVEN VESSELS UNDER 20 METERS (65.6 FT.) IN LENGTH.**

**CONSTRUCTION:**

- \* **CAST BRONZE**
- \* **MEDIUM SCREW BASE TYPE ELECTRICAL SOCKET**
- \* **FOR 12 OR 32 VOLTS, BULB NOT INCLUDED**

**ORDERING INFORMATION**

Description	Height Overall Inches	O.D. Base Inches	Tapped Pipe Size Inches	Plain Bronze Standard Pkg. - 1 Pc.	Screw Size	Ship Wt. Carton Lbs. Std. Pkg.
White All-Round	8-3/4	3-1/8	---	112 B00 PLB	8	2.5
Red All-Round	8-3/4	3-1/8	---	112 RB0 PLB	8	2.5
Green All-Round	8-3/4	3-1/8	---	112 GB0 PLB	8	2.5
Yellow All-Round	8-3/4	3-1/8	---	112 MB0 PLB	8	2.5
White All-Round	6-1/2	-----	1/2	309 B00 PLB	--	2.0
Red All-Round	6-1/2	-----	1/2	309 RB0 PLB	--	2.0
Green All-Round	6-1/2	-----	1/2	309 GB0 PLB	--	2.0
Yellow All-Round	6-1/2	-----	1/2	309 MB0 PLB	--	2.0

**SPARE PARTS ORDERING INFORMATION FOR FIGS. 108, 112 & 309**

**Spare Globes:**

White, Cat. No. 106 000 WHT.  
 Gray, Cat. No. 106 000 GRY.  
 Red, Cat. No. 106 000 RED.  
 Green, Cat. No. 106 000 GRN.  
 Yellow, Cat. No. 106 000 YLW.

Spare Medium Screw Base Socket, Cat. No. 226.  
 Spare Base and Gasket for Fig. 108, Cat. No. 222 DP BLK.

**Required Bulbs:**

12 Volts for Fig. 108 (2 Per card), Cat. No. 70 DP1 CLR.  
 12 Volts for White and Yellow Figs. 112 and 309, Cat. No. 340 005 FRD.  
 12 Volts for Red and Green Figs. 112 and 309, Cat. No. 340 006 FRD.  
 24 Volts for Fig. 108 (2 per Card), Cat. No. 67 DP2 CLR.  
 32 Volts for Fig. 108 (2 per Card), Cat. No. 70 DP2 CLR.  
 32 Volts for White and Yellow Figs. 112 and 309, Cat. No. 340 011 FRD.  
 32 Volts for Red and Green Figs. 112 and 309, Cat. No. 340 012 FRD.



## ALL-ROUND LIGHTS

**FIGS. 362 & 371 - CERTIFIED FOR USE ON SAIL OR POWER DRIVEN VESSELS UNDER 20 METERS (65.6 FT.) IN LENGTH**

**CONSTRUCTION:**

- \* FROSTED GLOBE, CAST BRONZE
- \* PLAIN OR CHROME PLATED
- \* DOUBLE CONTACT SOCKET, COMPLETE WITH 12 VOLT BULB



**FIG. 362**



**FIG. 371**



**ORDERING INFORMATION**

Vertical Height Inches	O.D. Base Inches	Plain Bronze Dealer Pkg.- 1 Pc. per Card	Chrome Plated Bronze Dealer Pkg.- 1 Pc. per Card	Tapped Screw Size	Pipe Size Inches	Ship Wt. Carton Lbs. Dealer Pkg.
1-1/2	-----	362 DP PLB	362 DP CHR	-----	1/2	3.0
1-1/2	2-1/2	371 DP PLB	371 DP CHR	8 F.H.	-----	2.5

Spare Bulbs (2 per card), Cat. No. 337 011 DP. Spare Globe, Cat. No. 248 000 FRD.  
Spare Socket, Cat. No. 24 DP1.

Navigation Lights for Vessels Under 20 Meters

## REPLACEMENT WHITE ALL-ROUND LIGHTS

**FIG. 1400 - CERTIFIED FOR USE ON SAIL OR POWER DRIVEN VESSELS UNDER 20 METERS (65.6 FT.) IN LENGTH.**

**UNIVERSAL REPLACEMENT WHITE ALL-ROUND LIGHT CONSTRUCTION**

- \* REPLACEMENT STOW-A-WAY PLUG-IN TYPE
- \* WHITE TRANSLUCENT GLOBE
- \* BLACK PLASTIC TOP
- \* 3/4 INCH DIAMETER ANODIZED ALUMINUM TUBE WITH LOCKING COLLAR
- \* BASES NOT INCLUDED
- \* 12 VOLT BULB INCLUDED
- \* SELECTIVE USE OF SCREW HOLES AND/OR COLLAR ALLOW FOR USE IN MULTIPLE APPLICATIONS



**ALL NEW Gold Plated CONTACTS**

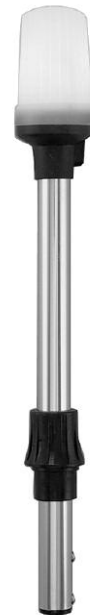

**FIG. 1400**



**ORDERING INFORMATION**

Approx. Length Inches	Dealer Pkg. 1 Pc. per Card	Cards Per Package	Ship Wt. Carton Lbs. Dealer Package
24	1400 DP2 CHR	10	5.5
30	1400 DP3 CHR	10	6.4
36	1400 DP4 CHR	10	7.0
42	1400 DP5 CHR	10	8.5
48	1400 DP6 CHR	10	9.0
54	1400 DP7 CHR	10	9.4

**USE FIG. 1400 WHITE ALL-ROUND AS A UNIVERSAL REPLACEMENT POLE LIGHT FOR COMBINATION POLE & BASE FIGS 1430, 1630, 1631, 1640 & 1660 FOR USE WITH THE FOLLOWING BASES:**



**Fig. 1059**  
16° RAKE



**Fig. 1060**  
5° RAKE



**Fig. 1046**  
5° RAKE



**Fig. 1047**  
0° RAKE



**Fig. 1045**  
0° RAKE

Bases Sold Separately

Note: The 1400 Series replaces the OLD 1400 and 1600 Series replacement lights.



## REPLACEMENT WHITE ALL-ROUND LIGHTS

**CERTIFIED FOR USE ON POWER DRIVEN VESSELS  
UNDER 20 METERS (65.6 FT.) IN LENGTH**

**"REDUCED GLARE" REPLACEMENT ALL-ROUND LIGHTS**  
**FIG. 1440, 1450 & 1460 - FITS PERKO STYLE VERTICAL BASES**  
**FIG. 1445, 1455 & 1465 - FITS PERKO STYLE BASES WITH 5° ANGLE**

### CONSTRUCTION:

- \* REPLACEMENT STOW-A-WAY PLUG-IN TYPE
- \* FIGS. 1440/1445 & 1450/1455 CLEAR FLUTED LENS WITH BLACK PLASTIC TOP
- \* FIGS. 1460/1465 CLEAR FLUTED LENS WITH FROSTED GLOBE & BLACK PLASTIC TOP
- \* FIGS. 1450 & 1455 FOLD IN HALF POLE
- \* 3/4 INCH DIAMETER ANODIZED ALUMINUM TUBE WITH LOCKING COLLAR
- \* BASES NOT INCLUDED
- \* 12 VOLT BULB INCLUDED



**ALL NEW**  
**Gold Plated**  
**CONTACTS**

See Page 22 & 23  
for Features



Fig. 1460



Fig. 1465



Fig. 1440



Fig. 1445

FIGS.  
1450/1455

### ORDERING INFORMATION

Approx. Length Inches	Closed Top Style Dealer Pkg. 1 Pc. per Card	Ship Wt. Carton Lbs. Dealer Pkg.	Clear Top Style Dealer Pkg. 1 Pc. per Card	Cards Per Package	Ship Wt. Carton Lbs. Dealer Pkg.
30	1440 DP3 CHR	6.6	1460 DP3 CHR	10	6.5
36	1440 DP4 CHR	7.4	1460 DP4 CHR	10	7.5
42	1440 DP5 CHR	8.1	1460 DP5 CHR	10	8.5
48	1440 DP6 CHR	4.9	1460 DP6 CHR	5	4.8
54	1440 DP7 CHR	5.3	1460 DP7 CHR	5	5.3
24	1445 DP2 CHR	5.6	1465 DP2 CHR	10	5.5
30	1445 DP3 CHR	6.2	1465 DP3 CHR	10	6.6
36	1445 DP4 CHR	7.4	1465 DP4 CHR	10	7.3
42	1445 DP5 CHR	8.0	1465 DP5 CHR	10	8.3
48	1445 DP6 CHR	4.9	1465 DP6 CHR	5	4.7
54	1445 DP7 CHR	5.0	1465 DP7 CHR	5	5.3

Approx. Length Inches	Closed Top Style Dealer Pkg. 5 Pcs 1 Pc. per Card	Closed Top Style OEM Bulk Pkg. 50 Pcs.	Ship Wt. Carton Lbs. DP/OEM Bulk
54	1455 DP7 CHR	1455 007 CHR	6.0/62.4

### FIGS. 1450/1455 FOLDING POLE

USE FIGS. 1440, 1450 & 1460 WHITE ALL-ROUND POLE LIGHTS AS A REPLACEMENT POLE LIGHT FOR THE FOLLOWING BASE(S)



0° RAKE  
Fig. 1045



0° RAKE  
Fig. 1047

REPLACEMENT BASES FOR FIG 1632 SERIES AND FIG 1660 SERIES.

USE FIGS. 1445, 1455 & 1465 WHITE ALL-ROUND POLE LIGHTS AS A REPLACEMENT POLE LIGHT FOR THE FOLLOWING BASE(S)



5° RAKE  
Fig. 1060



5° RAKE  
Fig. 1046

REPLACEMENT BASES FOR FIGS 1431 SERIES AND 1641 SERIES.

Bases Sold Separately



Navigation Lights for Vessels Under 20 Meters

## SPARE BASES FOR POLE LIGHTS

**FIGS. 1045, 1059-P & 1060-P - PLUG-IN TYPE, WATERPROOF SNAP-ON COVER**

**FIGS. 1045-300, & 1060-3B0 - 3 CONTACT PLUG-IN TYPE, WATERPROOF SNAP-ON COVER**

**FIG. 1045 P00 - FITS FIGS. 940, 970, 1612, 1631 & 1650 SERIES**

**FIG. 1045 300 - FITS FIGS. 1211 & 1421 SERIES**

**FIG. 1059 P00 - FITS FIGS. 1330 & 1630 SERIES**

**FIG. 1060 PB0 - FITS FIG. 1430 SERIES**

**FIG. 1060 3B0 - FITS FIGS. 1212 & 1422 SERIES**

**LOCKING COLLAR IS INCLUDED WITH BASE TO ALLOW INTERCHANGEABILITY WITH DISCONTINUED STYLE BASES**



### ORDERING INFORMATION

Length Overall Inches	Width Overall Inches	Insert Type	Replaces Cat. No.	Dealer Pkg. 5 Cards 1 Pc. per Card	Tube Angle Degrees	Ship Wt. Carton Lbs. Dealer Pkg.
2-1/4 O.D.	----	None	1023 P00 CHR	1045 P00 DP	0	1.9
2-1/4 O.D.	----	None	1023 300 CHR	1045 300 DP	0	1.9
3-3/4	1-5/8	None	1330 000 99A	1059 P00 DP	16	2.7
3-3/4	1-5/8	None	1026 P00 CHR	1059 P00 DP	16	2.7
3-3/4	1-3/4	Black	1027 PB0 CHR	1060 PB0 DP	5	2.2
3-3/4	1-3/4	Black	1027 3B0 CHR	1060 3B0 DP	5	2.2



**FIG. 1060 PB0 & 1060 3B0**



**FIG. 1059 P00**

**FIG. 1059-T & 1060-T - TELESCOPING TYPE**

**FIG. 1059 T00 - FITS FIG. 1311 & 1611 SERIES**

**FIG. 1060 TB0 - FITS FIG. 1411 SERIES**

**LOCKING COLLAR IS INCLUDED WITH BASE TO ALLOW INTERCHANGEABILITY WITH DISCONTINUED STYLE BASES**



### ORDERING INFORMATION

Length Overall Inches	Width Overall Inches	Insert Type	Replaces Cat. No.	Dealer Pkg. 5 Cards 1 Pc. per Card	Tube Angle Degrees	Ship Wt. Carton Lbs. Dealer Pkg.
3-3/4	1-5/8	None	1156 000 CHR	1059 T00 DP	16	2.4
3-3/4	1-5/8	None	1026 T00 CHR	1059 T00 DP	16	2.4
3-3/4	1-3/4	Black	1027 TB0 CHR	1060 TB0 DP	5	2.1



**FIG. 1059 T00**



**FIG. 1060 TB0**

**FIG. 1046 & 1047 - PLUG-IN TYPE, WATER RESISTANT SLIDE COVER**

**FIG. 1046 P00 - FITS FIG. 1640 SERIES**

**FIG. 1047 P00 - FITS FIG. 1296\* & 1660 SERIES**



### ORDERING INFORMATION

Length Overall Inches	Width Overall Inches	Dealer Pkg. - 5 Cards 1 Pc. per Card	Tube Angle Degrees	Ship Wt. Carton Lbs. Dealer Pkg.
3-1/2	1-1/2	1046 P00 DP	5	1.4
3-1/2	1-1/2	1047 P00 DP	0	1.5

\*Specify 3-Contact Base, Cat. No. 1047 3B0 DP.

**FIG. 1046**



**FIG. 1047**

**FIG. 1049 - MINI MOUNT BASE, WATER RESISTANT COVER**

**FIG. 1049 P00 - FITS FIGS. 1614, 1633 & 1651 SERIES**

**1049 3B0 - FITS 3 CONTACT POLE LIGHTS (IE FIGS 1211 & 1421)**

**REQUIRES POLES WITH THREADED COLLARS**



### ORDERING INFORMATION

Type of Top	Contacts	Width Overall Flange Inches	Dealer Pkg. - 5 Cards 1 Pc. per Card	Tube Angle Degrees	Ship Wt. Carton Lbs. Dealer Pkg.
Black	2	1-15/16 O.D.	1049 P00 DPB	0	1.3
Black	3	1-15/16 O.D.	1049 3B0 DPB	0	1.3
Chrome	2	1-15/16 O.D.	1049 P00 DPC	0	1.4
Chrome	3	1-15/16 O.D.	1049 3B0 DPC	0	1.4

Spare Cap for Base, All Black Cat. No. 1049 DPB 99A

Spare Cap for Base for Base, All Black w/ Chrome Insert Cat. No. 1049 DPC 99A



**CHR TOP**



**BLK TOP**



**FIG. 1125-99A & 1209-99A - PLUG-IN TYPE, WATERPROOF SCREW-ON CAP**

**FIG. 1125-99A - FITS FIG. 1125 AND FIG. 1209-99A - FITS FIG. 1209 SERIES**



### ORDERING INFORMATION

Length Overall Inches	Width Overall Inches	Dealer Pkg. - 5 Cards 1 Pc. per Card	Tube Angle Degrees	Ship Wt. Carton Lbs. Dealer Pkg.
3-3/8	2-1/4	1125 DP 99A	16	2.5
3-3/8	2-1/4	1209 DP 99A	16	2.5



**FIG. 1125-99A & 1209-99A**



Navigation Lights for Vessels Under 20 Meters

## SPARE BASES, BRACKETS FOR WINDSHIELD MOUNT LIGHTS

Navigation Lights for Vessels Under 20 Meters



**Fig. 1048**

**ALL NEW**  
Gold Plated  
CONTACTS

**FIG. 1048 - PLUG-IN TYPE WITH WATERPROOF SNAP-ON COVER  
FOR POLES WITH THREADED COLLARS  
FITS FIGS. 1621 & 1655 SERIES**



**ORDERING INFORMATION**

Length Overall Inches	Width Overall Inches	Dealer Pkg. 5 Cards 1 Pc. per Card	Tube Angle Degrees	Ship Wt. Carton Lbs. Dealer Pkg.
3-1/2	2	1048 P00 DP	5	1.5

**FIGS. 1052/1052A & 1054/1054A - FOLD-DOWN, ADJUSTABLE ANGLE BASE WITH PLASTIC ADAPTERS FOR "V" OR FLAT MOUNTING SURFACES COMPLETE WITH KNOB AND END PLUG**

**FIGS. 1052, 1052A, 1054 & 1054A**

**CONSTRUCTION:**

**\* CHROME PLATED ZINC ALLOY**



**Fig. 1052**



**Fig. 1054**

**FIGS. 1052/1054 - DOES NOT CONTAIN NOTCH FOR THROUGH BASE WIRING  
FIG. 1052 - HORIZONTAL MOUNT, FITS FIGS. 1134 & 1634  
FIG. 1054 - VERTICAL MOUNT, FITS FIGS. 1137 & 1637**



**Fig. 1052A**



**Fig. 1054A**

**FIGS. 1052A/1054A - CONTAINS NOTCH FOR THROUGH BASE WIRING  
FIG. 1052A - HORIZONTAL MOUNT, FITS FIGS. 1181 & 1281  
FIG. 1054A - VERTICAL MOUNT, FITS FIGS. 1184 & 1284**

**FIGS. 1052B & 1054B**

**CONSTRUCTION:**

**\* BLACK PLASTIC**

**FIGS. 1052B/1054B - CONTAINS NOTCH FOR THROUGH BASE WIRING  
UNIVERSAL MOUNTING BASE FITS ALL FOLD DOWN SERIES POLES  
FIGS. 1052B - HORIZONTAL MOUNT  
FIGS. 1054B - VERTICAL MOUNT**



**ORDERING INFORMATION**

Construction	Length Overall Inches	Width Overall Inches	Replaces Cat. No.	Dealer Pkg. 5 Cards 1 Pc. per Card	Ship Wt. Carton Lbs. Dealer Pkg.
Chr. Plated Zinc Alloy	2	1-1/2	1120 000 CHR	1052 DP CHR	2.0
Chr. Plated Zinc Alloy	2-1/4	5/8	1122 000 CHR	1054 DP CHR	1.8
Chr. Plated Zinc Alloy	2	1-1/2	1120 000 CHR	1052 DPA CHR	2.0
Chr. Plated Zinc Alloy	2-1/4	5/8	1122 000 CHR	1054 DPA CHR	1.8
Black Plastic	2	1-1/2	1120 000 CHR	1052 DPB BLK	1.1
Black Plastic	2-1/4	5/8	1122 000 CHR	1054 DPB BLK	1.1



**Fig. 1052B**

**IMPROVED ADJUSTABILITY**



**Fig. 1054B**

**FIGS. 1123-99A & 1124-99A - PLUG-IN TYPE, WATERPROOF SCREW-ON CAP WITH PLASTIC ADAPTERS FOR "V" OR FLAT MOUNT**

**FIG. 1123 - HORIZONTAL MOUNT, FITS FIGS. 1123 & 1273 SERIES  
FIG. 1124 - VERTICAL MOUNT, FITS FIGS. 1124 & 1274 SERIES**



**Fig. 1123-99A**

**ALL NEW**  
Gold Plated  
CONTACTS



**Fig. 1124-99A**



**ORDERING INFORMATION**

Dimensions Bracket Inches	Dealer Pkg. - 5 Cards 1 Pc. per Card	Ship Wt. Carton Lbs. Dealer Pkg.
2-1/4 x 3/4	1123 DP 99A	2.3
3/4 x 2-1/4	1124 DP 99A	2.5

## SPARE PARTS - LENSES

FOR NAVIGATION LIGHTS ON VESSELS UNDER 20 METERS (65.6 FT.) IN LENGTH

### 112-1/2° LENSES FOR BI-COLOR/TRI-COLOR LIGHTS

#### ORDERING INFORMATION

Color	Height Inches	Width Inches	Dealer Pkg. - 5 Cards 1 Set per Card
Red/Green	1-5/16	2-1/8	247 DP LNS*
Red/Green	1	1-3/4	283 DPA LNS*
Red/Green	1-1/4	1-3/8	296 DP LNS*
Red/Green	1-1/4	1-3/8	297 DP LNS*
Red/Green	2-1/2	2	259 DPA LNS
Red/Green	1-1/2	1	268 DP LNS
Red/Green	7/8	1-5/8 x 13/16	227 DP LNS*
Red/Green	1-1/8	3 x 1-5/8	241 DP LNS*
Red/Green	1-1/2	2-3/8	229 DP LNS*

\*One Piece Lens



### 112-1/2° LENSES FOR SIDE LIGHTS

#### ORDERING INFORMATION

Color	Height Inches	Width Inches	Dealer Pkg. - 5 Cards 1 Pc. per Card
Red	1-5/16	2-1/8	273 DPR LNS
Green	1-5/16	2-1/8	273 DPG LNS
Red	1-3/4	1-1/16	277 DPR LNS
Green	1-3/4	1-1/16	277 DPG LNS
Red	1	1-3/4	298 DPR LNS
Green	1	1-3/4	298 DPG LNS
Red	7/8	1-5/8	228 DPR LNS
Green	7/8	1-5/8	228 DPG LNS
Red	1-1/2	2-3/8	232 DPR LNS
Green	1-1/2	2-3/8	232 DPG LNS
Red/Green	1	1-9/16	281 DPA LNS*
Red/Green	1	1-9/16	295 DP LNS*
Red/Green	1-1/4	----	260 DP LNS*

\*Set of 1 Red and 1 Green Lens.



### 225° LENSES FOR MASTHEAD LIGHTS

#### ORDERING INFORMATION

Color	Height Inches	I.D. Inches	O.D. Inches	Dealer Pkg. - 5 Cards 1 Pc. per Card
White	1	1-9/16	2-3/16	281 DPA WHT
White	1-1/2	1	1-1/4	278 DP WHT*
White	1-1/2	1	1-1/4	295 DP WHT

\*Dealer Pkg., 5 cards - 2 Pcs. per card.



### 135° LENSES FOR STERN LIGHTS

#### ORDERING INFORMATION

Color	Height Inches	I.D. Inches	O.D. Inches	Dealer Pkg. - 5 Cards 1 Pc. per Card
Clear	1-1/4	1-9/16	2-3/16	74 DP WHT
Clear	1-1/2	1	1-1/4	278 DP WHT*
Clear	1-1/4	1-9/16	2-3/16	281 DPA WHT
Clear	-----	-----	2	284 DP CLR**
Clear	-----	-----	2	295 DP WHT

\*Dealer Pkg., 5 cards - 2 Pcs. per card. \*\*Includes Gasket.



### 360° LENSES FOR ALL-ROUND LIGHTS

#### ORDERING INFORMATION

Color	Height Inches	I.D. Inches	O.D. Inches	Dealer Pkg. - 5 Cards 1 Pc. per Card
White	3	1-1/2	1-9/16	201 DP WHT
Clear	2-1/2	1-11/16	2	248 DP CLR
Frosted	2-1/2	1-11/16	2	248 000 FRD*
Clear	3-5/16	3-3/16	----	261 JRO CLR*
Black/Clear	2	-----	2-1/4	238 DP BLK
Black/Clear	2	-----	2-1/4	239 DP BLK
Black/Clear	1-1/8	-----	3 x 1-5/8	240 DP LNS

\*Std Pkg., - 1 Pc. per card.



Navigation Lights for Vessels Under 20 Meters

FOR NAVIGATION LIGHTS ON VESSELS UNDER 20 METERS (65.6 FT.) IN LENGTH

Navigation Lights for Vessels Under 20 Meters



**FIG. 138**



**FIG. 290**

**FIGS. 138 & 290 - ELECTRIC ADAPTERS  
BRASS SPRING TYPE FOR DOUBLE ENDED BULBS**

**ORDERING INFORMATION**

O.D. Overall Inches	I.D. Light Opening Inches	Height Overall Inches	Standard Pkg. - 1 Pc.	Used With Light Series
2-3/16	1-7/8	3-3/4	138 F03	91, 98 & 99
4-1/2	3-3/16	4-3/4	290 F02	4, 5, 7, F02
4-1/2	3-3/16	5-1/4	290 F03	4, 5, 7, F03



**FIG. 52**



**FIG. 276**

**FIGS. 52 & 276 - DOUBLE CONTACT BAYONET SOCKETS  
BRASS, WITH 6 INCH WIRE LEADS - FIG. 276 TAPPED FOR 1/8 INCH PIPE**



**ORDERING INFORMATION**

Length Overall Inches	Standard Pkg. - 5 Pcs.	Dealer Pkg. - 10 Cards 1 Pc. per Card
1	-----	52 DP
1-1/2	276 000	
2	276 002	
2-3/8	276 003	



**FIG. 24 - DOUBLE CONTACT BAYONET SOCKET**

**BLACK PLASTIC BODY**



**FIG. 24**



**ORDERING INFORMATION**

Length Pigtail Inches	O.D. Inches	Dealer Pkg. - 10 Cards 1 Pc. per Card
10	3/4	24 DP1
60	3/4	24 DP2



**FIG. 1109 - SINGLE CONTACT BAYONET SOCKET - BRASS**



**FIG. 1109**



**ORDERING INFORMATION**

Length Pigtail Inches	Length Socket Inches	O.D. Inches	Dealer Pkg. - 10 Cards 1 Pc. per Card
6	5/8	3/8	1109 DP



## SPARE BULBS FOR NAVIGATION LIGHTS

FOR NAVIGATION LIGHTS ON VESSELS UNDER 20 METERS (65.6 FT.) IN LENGTH

**FIG. 337 - DOUBLE CONTACT BAYONET BASE BULB**

**ORDERING INFORMATION**

Nominal Voltage	Wattage	Amps	Dealer Pkg. 5 cards	Bulbs per card	Bulb Diameter Inches	Mfr. Lamp No.
12	7	.58	337 011 DP	2	3/4	90
12	11	.94	337 012 DP	2	3/4	1004
24	15	.63	337 014 DP	1	1	306
32	13	.40	337 018 DP	1	3/4	624



**FIG. 337**



Navigation Lights for Vessels Under 20 Meters

**FIG. 375 - DOUBLE CONTACT BAYONET INDEXING BASE BULB**

**ORDERING INFORMATION**

Nominal Voltage	Wattage	Amps	Standard Pkg. - 1 bulb
12	10	.83	375 12V 10W
12	25	2.08	375 12V 25W
24	10	.42	375 24V 10W
24	25	1.04	375 24V 25W
32	10	.31	375 32V 10W
32	25	.78	375 32V 25W

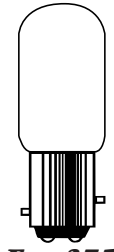

**FIG. 375**

**FIG. 340 - MEDIUM SCREW BASE BULB**

**ORDERING INFORMATION**

Nominal Voltage	Wattage	Amps	Standard Pkg. - 6 bulbs	Type	L.C.L. Inches	Mfr. Lamp No.
12	15	1.25	340 005 FRD	A-17	2-3/8	15-A
12	25	2.08	340 006 FRD	A-19	2-9/16	25-A
32	15	.47	340 011 FRD	A-17	2-3/8	15-A
32	25	.78	340 012 FRD*	A-19	2-9/16	25-A

\*Standard Pkg. - 2 bulbs



**FIG. 340**



**FIG. 338 WEDGE BASE BULBS**

**ORDERING INFORMATION**

Nominal Voltage	Wattage	Amps	Dealer Pkg. - 5 cards 2 Bulbs per card	Bulb Diameter Inches	Bulb Length Inches
12	5	.35	338 DP1 CLR	13/32	1-1/16
12	9	.69	338 DP2 CLR	5/8	1-1/2

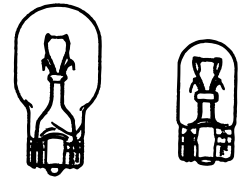

**FIG. 338 #2 FIG. 338 #1**



**FIGS. 67, 69, 70, 71 & 72 FESTOON BULBS - DOUBLE ENDED**

**ORDERING INFORMATION**

Nominal Voltage	Wattage	Amps	Dealer Pkg. - 5 cards 2 Bulbs per card	Bulb Diameter Inches	Bulb Length Inches
12	8	.70	71 DP8 CLR	3/8	1-1/8
12	10	.83	69 DP CLR	3/8	1-5/8
12	10	.74	70 DP0 CLR	3/8	1-11/16
12	15	.97	70 DP1 CLR	9/16	1-11/16
12	10	.80	71 DP CLR	3/8	1-1/8
24	8	.35	72 DP8 CLR	3/8	1-1/8
24	10	.42	67 DP1 CLR	3/8	1-11/16
24	18	.75	67 DP2 CLR	9/16	1-11/16
24	10	.40	72 DP1 CLR	3/8	1-1/8
32	12	.40	70 DP2 CLR	3/8	1-5/8



**FIG. 67  
FIG. 69  
FIG. 70  
FIG. 71  
FIG. 72**



### FOR NAVIGATION LIGHTS ON VESSELS OVER 20 METERS (65.6 FT.) IN LENGTH

On March 31, 1977, the U.S. Coast Guard published in the Federal Register, an amendment to the navigation and navigable water regulations, which added a new subchapter DD, (33CFR87). This subchapter contains rules implementing and interpreting the International Regulations for Preventing Collisions at Sea, 1972 ('72 COLREGS). The International Regulations for Preventing Collisions at Sea, 1960, were replaced by the '72 COLREGS at 1200 hours, zone time on July 15, 1977. Therefore, all vessels on the high seas must comply with the '72 COLREGS at this time. In addition, with the enactment of the U.S. Inland Navigation Rules Act of 1980, the Inland Rules, Western Rules, and Great Lakes Rules were unified into a single set of requirements. The effective date for this legislation was December 24, 1981 (March 1, 1983 for Great Lakes). Therefore, all vessels must comply with these rules at this time.

Rules 21 and 22 of the '72 COLREGS and the U.S. Inland Navigation Rules give the color and range requirements for various navigation lights. Annex 1 to the '72 COLREGS and the U.S. Inland Navigation Rules gives positioning and technical details for these lights.

### U.S. COAST GUARD ACCEPTANCE OF NAVIGATION LIGHTS

All U.S. Registered vessels are subject to either the '72 COLREGS or the U.S. Inland Rules. The U.S. Coast Guard is accepting lights that have passed the U.L. tests (U.L. Standard 1104) as meeting the '72 COLREGS and the U.S. Inland Rules for vessels over 20 meters (65.6 ft.) in length. U.S. requirements for smaller vessels are less strict. As the first domestic manufacturer to pass U.L.1104, PERKO's lights can be installed on vessels over 20 meters (65.6 ft.) in length. Some models are designed for use on vessels over 20 meters (65.6 ft.) in length, while others are designed for use on vessels 20 meters (65.6 ft.) to 50 meters (164.0 ft.) in length.

A brass tag is permanently affixed to the light indicating the type of light, catalog no., voltage and bulb type to install to meet the visibility requirements. It also states that the light is classified by U.L. in accordance with the '72 COLREGS. This is the only documentation needed by a vessel for navigation lights to certify light construction compliance with the '72 COLREGS and the Inland Navigation Rules, and eliminates the former "Certificate of Compliance".



### EACH LIGHT HAS ITS OWN SERIAL NO. FOR IDENTIFICATION.

The lights indicated for use on vessels over 20 meters (65.6 ft.) in length have passed U.L.1104. The facsimile of the tag shown above is used on our cast bronze lights. Similar rectangular tags are used on other style lights.

Please note that any changes made to PERKO Navigation lights, including substitution of bulbs other than those shown in our catalog, instruction sheets, or metal tags (affixed to some lights) will void all certifications and U.S. Coast Guard acceptance.

For the present, the U.S. Coast Guard will not publish a list of U.L. classified lights. However, field offices have been notified. For more detailed information, consult the complete '72 COLREGS, the U.S. Inland Navigation Rules, and your local U.S. Coast Guard office.

### SPECIAL PURPOSE LIGHTS

Other lights (not shown) for use where the vessel is subject to special local requirements are available. Contact PERKO for further information.



## NAVIGATION LIGHTS

**FIGS. 1127 - 1130 SERIES - CERTIFIED FOR USE ON VESSELS 20 METERS (65.6 FT.) TO 50 METERS (164.0 FT.) IN LENGTH**

**CONSTRUCTION:**

- \* **BLACK PLASTIC**
- \* **PRE-WIRED DOUBLE CONTACT SOCKET AND 3 FEET OF 16/3-SO CABLE**
- \* **FOR 12, 24, 32 OR 120 VOLTS. BULB NOT INCLUDED**
- \* **WATERTIGHT ACCESS CAP FOR REBULBING AND CLEANING**



Height Overall Inches	Height Lens Inches	Screw Size
7-1/2	4-1/2	1/4

**ORDERING INFORMATION**

Description	Visibility Arc	Visibility Miles	Catalog Number Std Pkg. 1 Pc.	Ship Wt. Carton Lbs. Standard Pkg.
Red Side Light	112-1/2°	2	1127 RA0 BLK	2.7
Green Side Light	112-1/2°	2	1127 GA0 BLK	2.7
White Masthead Light	225°	5	1128 A00 BLK	2.6
White Stern Light*	135°	2	1129 A00 BLK	2.7
Yellow Towing Light	135°	2	1129 MA0 BLK	2.7
White All-Round Light*	360°	2	1130 A00 BLK	2.5
White All-Round Light**	360°	5	1130 HA0 BLK	2.5
Red All-Round Light	360°	2	1130 RA0 BLK	2.5
Green All-Round Light	360°	2	1130 GA0 BLK	2.5
Yellow All-Round Light	360°	2	1130 MA0 BLK	2.5

\*These lights are supplied with a Gray Tinted Lens.  
 \*\*For Great Lakes use.



**FIG. 1127  
RED & GREEN SIDE LIGHTS  
112-1/2 DEGREES**



**FIG. 1128  
MASTHEAD LIGHT  
225 DEGREES**



**FIG. 1129  
STERN OR  
TOWING LIGHT  
135 DEGREES**



**FIG. 1130  
ALL-ROUND  
LIGHT  
360 DEGREES**

**IMPORTANT BULB DATA**

To comply with U.L. Standard 1104, the lights listed on this page must use a PERKO Cat. No. 374 bulb.

**SPARE PARTS ORDERING INFORMATION**

Spare Lens Assemblies:

- Red, Cat. No. 249 000 RED.
- Green, Cat. No. 249 000 GRN.
- White, Cat. No. 249 000 CLR.
- Gray, Cat. No. 249 000 GRY.
- Yellow, Cat. No. 249 000 YLW.

- Spare Double Contact Socket, Cat. No. 134.
- Spare Access Cap, O-Ring and Retainer, Cat. No. 1105 000 BLK.
- Spare O-Ring for Cap, Cat. No. 1119.

Required Bulbs:

- 12 Volts, Cat. No. 374 001 CLR.
- 24 Volts, Cat. No. 374 002 CLR.
- 32 Volts, Cat. No. 374 003 CLR.
- 120 Volts, Cat. No. 374 004 CLR.

Navigation Lights for Vessels Over 20 Meters

## SINGLE LENS NAVIGATION LIGHTS



**FIGS. 1369 - 1372 SERIES - CERTIFIED FOR USE ON VESSELS OVER 20 METERS (65.6 FT.) IN LENGTH**

### CONSTRUCTION:

- \* **LIGHTWEIGHT BUT DURABLE, FIBER-FILLED POLYCARBONATE BLACK PLASTIC**
- \* **COMPLETE WITH A PRE-WIRED MEDIUM PREFOCUS SOCKET**
- \* **INCLUDES ONE 3 FOOT LENGTH OF 16/3-SO CABLE THROUGH WATERTIGHT TERMINAL TUBES**
- \* **WATERTIGHT ACCESS CAP FOR REBULBING AND CLEANING**
- \* **24, 120 & 220 VOLT OPTIONS, BULB NOT INCLUDED**
- \* **ROUGH SERVICE BULBS ARE AVAILABLE**

### ORDERING INFORMATION

Description	Height Overall Inches	Height Lens Inches	Visibility Arc	Visibility Miles	Single Stack Cat No. Std. Pkg. 1 Pc	Mounting Bolt Size Inches	Ship Wt. Carton Lbs. Standard Pkg.
Red Side Light	9-1/4	6-3/4	112-1/2°	3	1372 RE0 BLK	3/8	4.4
Green Side Light	9-1/4	6-3/4	112-1/2°	3	1372 GE0 BLK	3/8	4.4
White Masthead Light	9-1/4	6-3/4	225°	6	1373 E00 BLK	3/8	4.1
White Stern Light**	9-1/4	6-3/4	135°	3	1374 E00 BLK	3/8	4.4
Yellow Towing Light	9-1/4	6-3/4	135°	3	1374 ME0 BLK	3/8	4.4
White All-Round Light**	9-1/4	6-3/4	360°	3	1369 E00 BLK	3/8	4.1
White All-Round Light***	9-1/4	6-3/4	360°	6	1369 HE0 BLK	3/8	4.1
Red All-Round Light	9-1/4	6-3/4	360°	3	1370 RE0 BLK	3/8	4.1
Green All-Round Light	9-1/4	6-3/4	360°	3	1370 GE0 BLK	3/8	4.1
Yellow All-Round Light	9-1/4	6-3/4	360°	3	1370 ME0 BLK	3/8	4.1

Special lights to meet local requirements are available upon request.

\*\*These lights are supplied with a Gray Tinted Lens.

\*\*\*For Great Lakes use.



**Fig. 1372  
Green Side Light**

**Fig. 1370  
Green  
All-Round**



**Fig. 1370  
Red  
All-Round**



**Fig. 1372  
Red Side Light**



**Fig. 1373  
White Masthead**



**Fig. 1370  
Yellow All-Round**



**Fig. 1374  
White Stern**

### IMPORTANT BULB DATA

**TO COMPLY WITH THE U.L. STANDARD 1104, THE LIGHTS LISTED ON THIS PAGE MUST BE USED WITH THE FOLLOWING PERKO CATALOG NUMBERS: 24 VOLT USE CAT. No. 342 024 CLR, 120 VOLT USE CAT. No. 342 004 CLR BULB OR 342 RS4 CLR BULB WHEN A "ROUGH SERVICE" BULB IS REQUIRED AND 220 VOLT USE CAT. No. 342 220 CLR.**

### SPARE PARTS ORDERING INFORMATION

- 1) Access Cap Assembly, Cat. No. 1363 SGL BLK.
- 2) Medium Prefocus Socket, Cat. No. 367.
- 3) Spare Bulb Information: 24V = 342 024 CLR, 120V = 342 004 CLR & 342 RS4 CLR, 220V = 342 220 CLR

For Spare Parts, Technical Information and Illustrations, See Page 54.

## DOUBLE LENS NAVIGATION LIGHTS

**FIGS. 1364 - 1368 SERIES - CERTIFIED FOR USE ON VESSELS OVER 20 METERS (65.6 FT.) IN LENGTH**



### CONSTRUCTION:

- \* **LIGHTWEIGHT BUT DURABLE, FIBER-FILLED POLYCARBONATE BLACK PLASTIC**
- \* **COMPLETE WITH A PRE-WIRED MEDIUM PREFOCUS SOCKET**
- \* **INCLUDES TWO 3 FOOT LENGTHS OF 16/3-SO CABLE THROUGH WATERTIGHT TERMINAL TUBES**
- \* **WATERTIGHT ACCESS CAP FOR REBULBING AND CLEANING**
- \* **24, 120 & 220 VOLT OPTIONS, BULBS NOT INCLUDED**
- \* **ROUGH SERVICE BULBS ARE AVAILABLE**

### ORDERING INFORMATION

Description	Height Overall Inches	Height Lens Inches	Visibility Arc	Visibility Miles	Double Stack Cat. No. Std. Pkg. 1 Pc	Mounting Bolt Size Inches	Ship Wt. Carton Lbs. Standard Pkg.
Red Side Light	17-1/4	6-3/4	112-1/2°	3	1364 RE0 BLK	3/8	6.9
Green Side Light	17-1/4	6-3/4	112-1/2°	3	1364 GE0 BLK	3/8	6.9
White Masthead Light	17-1/4	6-3/4	225°	6	1365 E00 BLK	3/8	6.5
White Stern Light*	17-1/4	6-3/4	135°	3	1366 E00 BLK	3/8	6.8
Yellow Towing Light	17-1/4	6-3/4	135°	3	1366 ME0 BLK	3/8	6.8
White All-Round Light**	17-1/4	6-3/4	360°	3	1367 E00 BLK	3/8	6.0
White All-Round Light***	17-1/4	6-3/4	360°	6	1367 HE0 BLK	3/8	6.0
Red All-Round Light	17-1/4	6-3/4	360°	3	1368 RE0 BLK	3/8	6.0
Green All-Round Light	17-1/4	6-3/4	360°	3	1368 GE0 BLK	3/8	6.0
Yellow All-Round Light	17-1/4	6-3/4	360°	3	1368 ME0 BLK	3/8	6.0

Special lights to meet local requirements are available upon request.

\*\*These lights are supplied with a Gray Tinted Lens.

\*\*\*For Great Lakes use.



**Fig. 1364  
Green Side Light**



**Fig. 1368  
Red All-Round**



**Fig. 1366  
Yellow Towing**



**Fig. 1367  
White All-Round**



**Fig. 1364  
Red Side Light**

### IMPORTANT BULB DATA

**TO COMPLY WITH THE U.L. STANDARD 1104, THE LIGHTS LISTED ON THIS PAGE MUST BE USED WITH THE FOLLOWING PERKO CATALOG NUMBERS: 24 VOLT USE CAT. No. 342 024 CLR, 120 VOLT USE CAT. No. 342 004 CLR BULB OR 342 RS4 CLR BULB WHEN A "ROUGH SERVICE" BULB IS REQUIRED AND 220 VOLT USE CAT. No. 342 220 CLR.**

### SPARE PARTS ORDERING INFORMATION

- 1) Access Cap Assembly Including Top Socket, Cat. No. 1363 DBL BLK.
- 2) Medium Prefocus Socket, Cat. No. 367
- 3) Spare Bulb Information: 24V = 342 024 CLR, 120V= 342 004 CLR & 342 RS4 CLR, 220V= 342 220 CLR

For Spare Parts, Technical Information and Illustrations, See Page 54.

Navigation Lights for Vessels Over 20 Meters

## SINGLE LENS NAVIGATION LIGHTS

**FIGS. 1169 - 1172 SERIES - CERTIFIED FOR USE ON VESSELS OVER 20 METERS (65.6 FT.) IN LENGTH**



### CONSTRUCTION:

- \* HEAVY DUTY CAST BRONZE
- \* PRE-WIRED MEDIUM PREFOCUS SOCKET
- \* 3 FEET OF 16/3-SO CABLE THROUGH A WATERTIGHT TERMINAL TUBE
- \* WATERTIGHT ACCESS CAP FOR REBULBING AND CLEANING
- \* 120 VOLT BULB NOT INCLUDED
- \* ROUGH SERVICE BULBS ARE AVAILABLE

### ORDERING INFORMATION

Description	Height Overall Inches	Height Lens Inches	Visibility Arc	Visibility Miles	Single Stack Cat. No. Std. Pkg. 1 Pc	Mounting Bolt Size Inches	Ship Wt. Carton Lbs. Standard Pkg.
Red Side Light	9-1/4	6-3/4	112-1/2°	3	1172 RE0 PLB	3/8	12.4
Green Side Light	9-1/4	6-3/4	112-1/2°	3	1172 GE0 PLB	3/8	12.4
White Masthead Light	9-1/4	6-3/4	225°	6	1173 E00 PLB	3/8	12.4
White Stern Light**	9-1/4	6-3/4	135°	3	1174 E00 PLB	3/8	12.3
Yellow Towing Light	9-1/4	6-3/4	135°	3	1174 ME0 PLB	3/8	12.3
White All-Round Light**	9-1/4	6-3/4	360°	3	1169 E00 PLB	3/8	11.2
White All-Round Light***	9-1/4	6-3/4	360°	6	1169 HE0 PLB	3/8	11.2
Red All-Round Light	9-1/4	6-3/4	360°	3	1170 RE0 PLB	3/8	11.2
Green All-Round Light	9-1/4	6-3/4	360°	3	1170 GE0 PLB	3/8	11.2
Yellow All-Round Light	9-1/4	6-3/4	360°	3	1170 ME0 PLB	3/8	11.2

Special lights to meet local requirements are available upon request.

\*\*These lights are supplied with a Gray Tinted Lens.

\*\*\*For Great Lakes use.



**Fig. 1172  
Green Side Light**

**Fig. 1170  
Green  
All-Round**



**Fig. 1170  
Red  
All-Round**



**Fig. 1172  
Red Side Light**



**Fig. 1173  
White Masthead**



**Fig. 1170  
Yellow All-Round**



**Fig. 1174  
White Stern**

### IMPORTANT BULB DATA

**To comply with U.L. STANDARD 1104, THE LIGHTS LISTED ON THIS PAGE MUST USE A PERKO CAT. No. 342 004 CLR BULB OR 342 RS4 CLR BULB WHEN A "ROUGH SERVICE" BULB IS REQUIRED**

### SPARE PARTS ORDERING INFORMATION

#### Spare Lenses:

Red, Cat. No. 261 001 RED  
Green, Cat. No. 261 001 GRN  
White, Cat. No. 261 001 CLR  
Gray, Cat. No. 261 001 GRY  
Yellow, Cat. No. 261 001 YLW

Spare Lens Gasket, Cat. No. 1143.  
Spare O-Ring for Cap, Cat. No. 1119.  
Spare Medium Prefocus Socket, Cat. No. 367.  
Spare Lens Retaining Clip with Bolt, Cat. No. 1133.  
Spare Access Cap, O-Ring and Retainer, Cat. No. 1105 000 BLK.

See Technical Information and Illustrations on Page 55.

## DOUBLE LENS NAVIGATION LIGHTS

**FIGS. 1164 - 1168 SERIES - CERTIFIED FOR USE ON VESSELS OVER 20 METERS (65.6 FT.) IN LENGTH**



### CONSTRUCTION:

- \* **HEAVY DUTY CAST BRONZE**
- \* **PRE-WIRED MEDIUM PREFOCUS SOCKET IN EACH COMPARTMENT**
- \* **TWO 3 FOOT LENGTHS OF 16/3-SO CABLE THROUGH A WATERTIGHT TERMINAL TUBE**
- \* **WATERTIGHT ACCESS CAP FOR REBULBING AND CLEANING**
- \* **120 VOLT BULB NOT INCLUDED**
- \* **ROUGH SERVICE BULBS ARE AVAILABLE**

### ORDERING INFORMATION

Description	Height Overall Inches	Height Lens Inches	Visibility Arc	Visibility Miles	Double Stack Cat. No. Std. Pkg. 1 Pc	Mounting Bolt Size Inches	Ship Wt. Carton Lbs. Standard Pkg.
Red Side Light	17-1/4	6-3/4	112-1/2°	3	1164 RE0 PLB	3/8	22.8
Green Side Light	17-1/4	6-3/4	112-1/2°	3	1164 GE0 PLB	3/8	22.8
White Masthead Light	17-1/4	6-3/4	225°	6	1165 E00 PLB	3/8	21.5
White Stern Light**	17-1/4	6-3/4	135°	3	1166 E00 PLB	3/8	22.8
Yellow Towing Light	17-1/4	6-3/4	135°	3	1166 ME0 PLB	3/8	22.8
White All-Round Light**	17-1/4	6-3/4	360°	3	1167 E00 PLB	3/8	20.1
White All-Round Light***	17-1/4	6-3/4	360°	6	1167 HE0 PLB	3/8	20.1
Red All-Round Light	17-1/4	6-3/4	360°	3	1168 RE0 PLB	3/8	20.1
Green All-Round Light	17-1/4	6-3/4	360°	3	1168 GE0 PLB	3/8	20.1
Yellow All-Round Light	17-1/4	6-3/4	360°	3	1168 ME0 PLB	3/8	20.1

Special lights to meet local requirements are available upon request.

\*\*These lights are supplied with a Gray Tinted Lens.

\*\*\*For Great Lakes use.



**Fig. 1164**  
**Green Side Light**



**Fig. 1168**  
**Red All-Round**



**Fig. 1166**  
**Yellow Towing**



**Fig. 1167**  
**White All-Round**



**Fig. 1164**  
**Red Side Light**

### IMPORTANT BULB DATA

**TO COMPLY WITH U.L. STANDARD 1104, THE LIGHTS LISTED ON THIS PAGE MUST USE A PERKO CAT. NO. 342 004 CLR BULB OR 342 RS4 CLR BULB WHEN A "ROUGH SERVICE" BULB IS REQUIRED**

#### Spare Lenses:

- Red, Cat. No. 261 001 RED
- Green, Cat. No. 261 001 GRN
- White, Cat. No. 261 001 CLR
- Gray, Cat. No. 261 001 GRY
- Yellow, Cat. No. 261 001 YLW

#### SPARE PARTS ORDERING INFORMATION

- Spare Lens Gasket, Cat. No. 1143.
- Spare O-Ring for Cap, Cat. No. 1119.
- Spare Dual Medium Prefocus Socket Assembly, Cat. No. 303.
- Spare Lens Retaining Clip with Bolt, Cat. No. 1133.
- Spare Plastic Cap, O-Ring and Retainer, Cat. No. 1105 000 BLK.

See Technical Information and Illustrations on Page 55.

Navigation Lights for Vessels Over 20 Meters

Fig. Nos. 1364 to 1374 Series Single & Double Lens Navigation Light Technical Information (See Lights on Page 50 & 51)

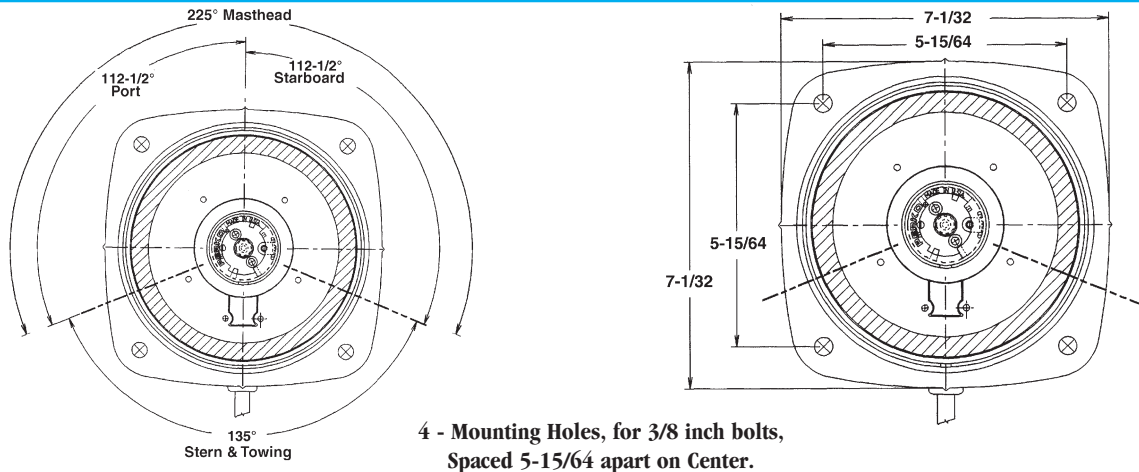

Fig. Nos. 1369 to 1374 Series Single Lens Navigation Light Technical Information (See Lights on Page 50)

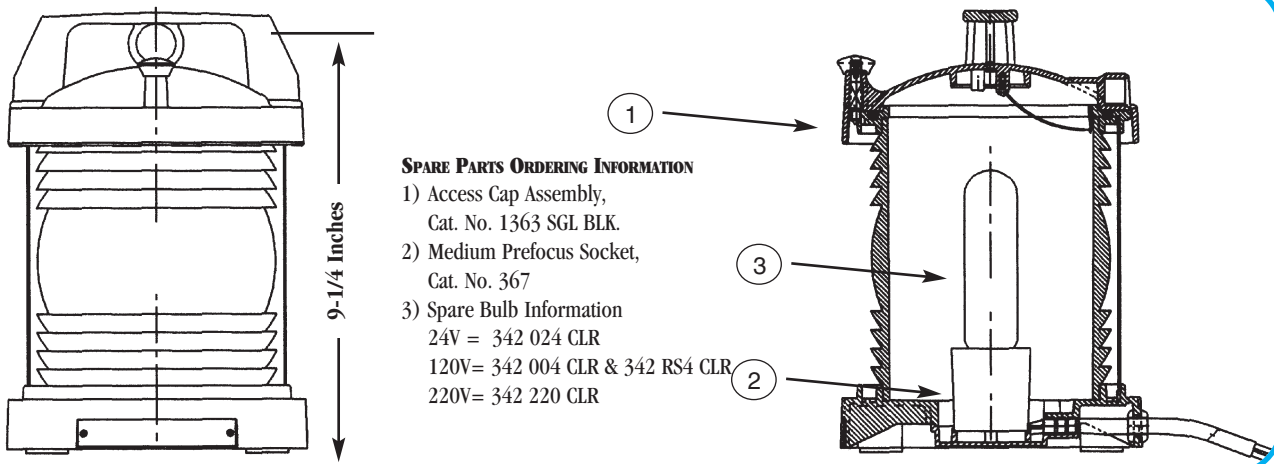
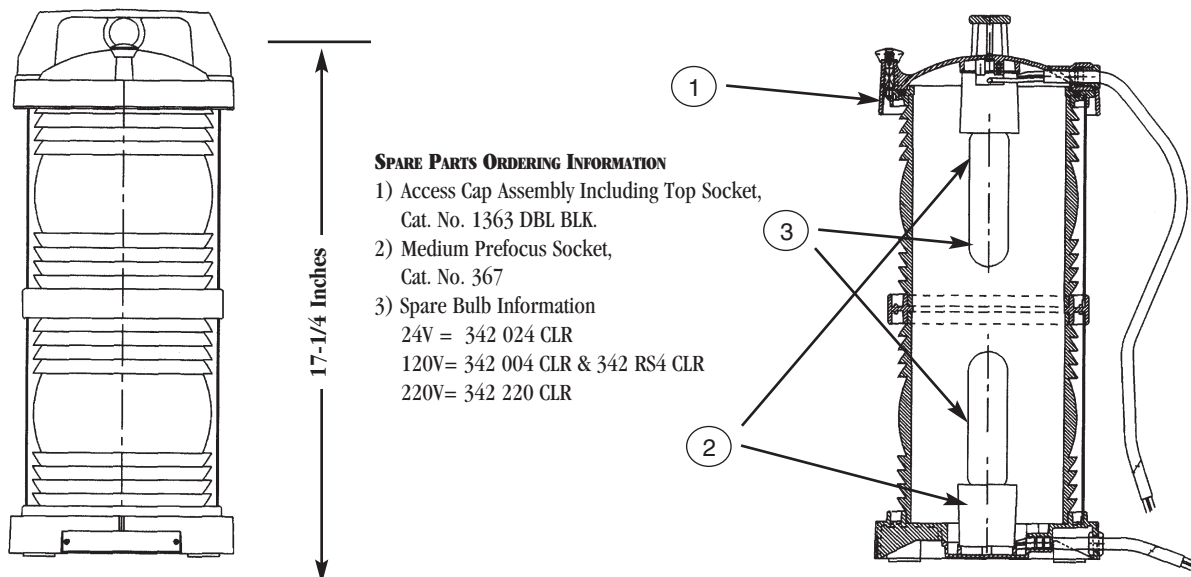

Fig. Nos. 1364 to 1368 Series Double Lens Navigation Light Technical Information (See Lights on Page 51)



Navigation Lights for Vessels Over 20 Meters

## NAVIGATION LIGHTS - TECHNICAL INFORMATION

Fig. Nos. 1127 to 1130 Series Navigation Light Technical Information (See Lights on Page 49)

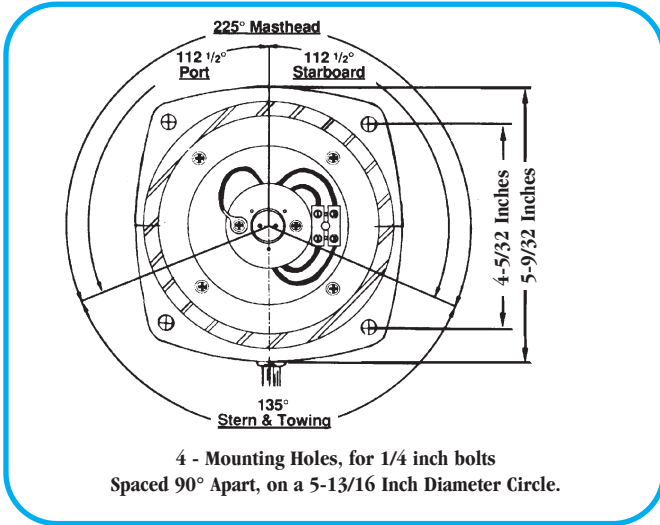

### SPARE PARTS ORDERING INFORMATION

- 1) Access Cap, O-Ring and Retainer, Cat. No. 1105 000 BLK.
- 2) O-Ring for Cap, Cat. No. 1119.
- 3) Lens Assembly:  
Red, Cat. No. 249 000 RED.  
Green, Cat. No. 249 000 GRN.  
White, Cat. No. 249 000 CLR.  
Gray, Cat. No. 249 000 GRY.  
Yellow, Cat. No. 249 000 YLW.
- 4) Double Contact Socket, Cat. No. 134.

Required Bulbs:  
12 Volts, Cat. No. 374 001 CLR.  
24 Volts, Cat. No. 374 002 CLR.  
32 Volts, Cat. No. 374 003 CLR.  
120 Volts, Cat. No. 374 004 CLR.

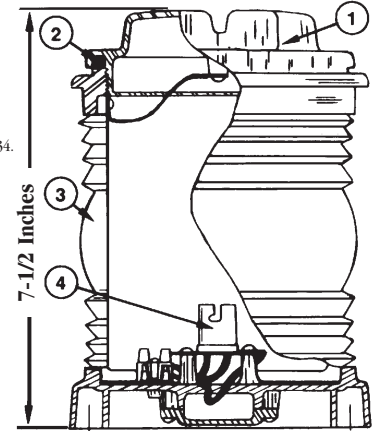

Navigation Lights for  
Vessels Over 20 Meters

Fig. Nos. 1169 to 1174 Series Single Lens Navigation Light Technical Information (See Lights on Page 52)

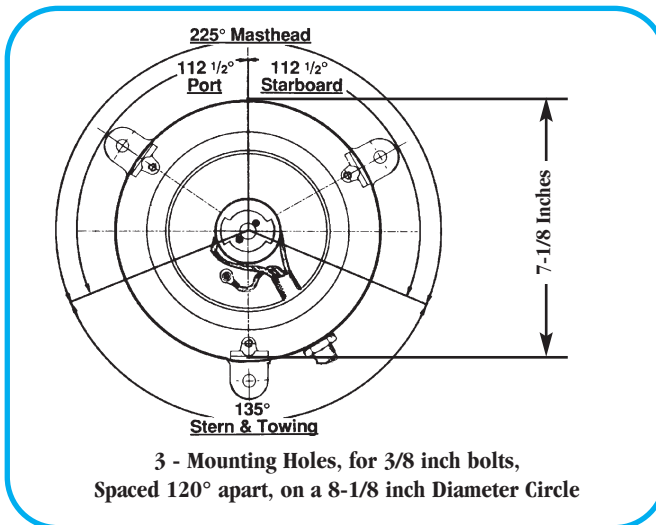

### SPARE PARTS ORDERING INFORMATION

- 1) Access Cap, O-Ring and Retainer, Cat. No. 1105 000 BLK.
- 2) O-Ring for Cap, Cat. No. 1119.
- 3) Lens Gasket, Cat. No. 1143.
- 4) Spare Lenses:  
Red, Cat. No. 261 001 RED  
Green, Cat. No. 261 001 GRN  
White, Cat. No. 261 001 CLR  
Gray, Cat. No. 261 001 GRY  
Yellow, Cat. No. 261 001 YLW
- 5) Lens Retaining Clip with Bolt, Cat. No. 1133.
- 6) Medium Prefocus Socket, Cat. No. 367. (Replaces Cat. No. 347)

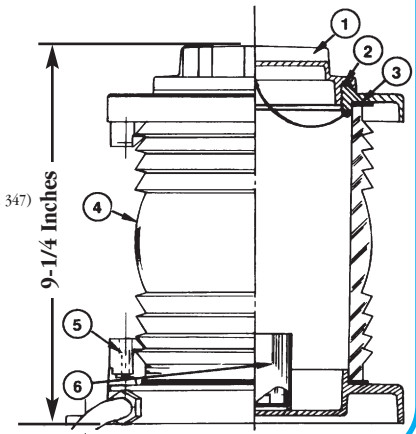
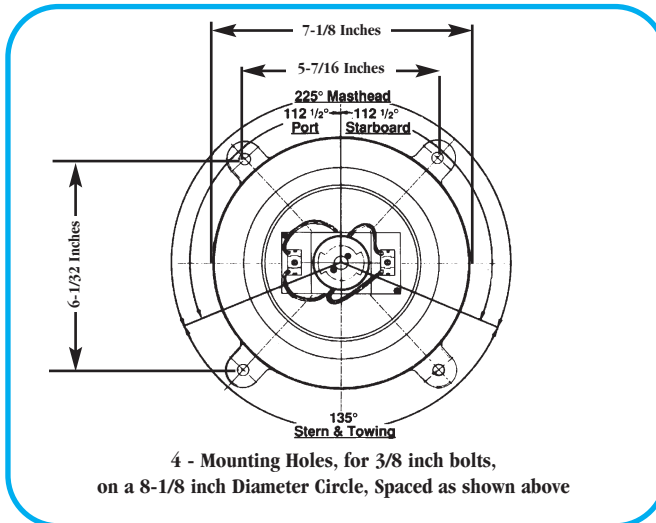
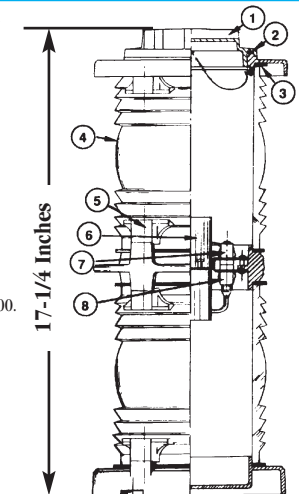

Fig. Nos. 1164 to 1168 Series Double Lens Navigation Light Technical Information (See Lights on Page 53)



### SPARE PARTS ORDERING INFORMATION

- 1) Access Cap, O-Ring and Retainer, Cat. No. 1105 000 BLK.
- 2) O-Ring for Cap, Cat. No. 1119.
- 3) Lens Gasket, Cat. No. 1143.
- 4) Spare Lenses:  
Red, Cat. No. 261 001 RED  
Green, Cat. No. 261 001 GRN  
White, Cat. No. 261 001 CLR  
Gray, Cat. No. 261 001 GRY  
Yellow, Cat. No. 261 001 YLW
- 5) Lens Retaining Clip with Bolt, Cat. No. 1133.
- 6) Dual Medium Prefocus Socket Assembly, Cat. No. 303.
- 7) Male Electrical Plug, Cat. No. 303 A00.
- 8) Female Electrical Receptacle, Cat. No. 303 B00.



## NAVIGATION LIGHTS

**FIGS. 1150 - 1154 SERIES - CERTIFIED FOR USE ON VESSEL LENGTHS AS SPECIFIED BELOW**



- CONSTRUCTION:**
- \* SHEET METAL, PREPRIMED GALVANIZED STEEL
  - \* MEDIUM PREFOCUS SOCKET
  - \* WATERTIGHT TERMINAL TUBE FOR 16/3-SO CABLE
  - \* WATERTIGHT ACCESS CAP FOR REBULBING AND CLEANING
  - \* 120 VOLT BULB NOT INCLUDED



Navigation Lights for Vessels Over 20 Meters

Size No.	Height Overall Inches	Height Lens Inches
1	11-1/2	6-3/4
2	13-1/2	7-1/2

### ORDERING INFORMATION

**CERTIFIED FOR USE ON VESSELS 20 METERS (65.6 FT.) TO 50 METERS (164.0 FT.) IN LENGTH.**

Description	Catalog No. Standard Pkg. 1 Pc.	Visibility Arc	Visibility Miles	Required Bulb	Ship Wt. Carton Lbs. Std. Pkg.
Red Side Light	1150 RE1 GAL	112-1/2°	2	342 002 CLR	6.3
Green Side Light	1150 GE1 GAL	112-1/2°	2	342 002 CLR	6.3
White Masthead Light	1151 E01 GAL	225°	5	342 003 CLR	6.3
White Stern Light	1152 E01 GAL	135°	2	342 000 CLR	6.1
Yellow Towing Light	1152 ME1 GAL	135°	2	342 000 CLR	6.1
White All-Round Light	1153 E01 GAL	360°	2	342 001 CLR	6.7
Red All-Round Light	1154 RE1 GAL	360°	2	342 004 CLR*	6.7
Green All-Round Light	1154 GE1 GAL	360°	2	342 003 CLR	6.7
Yellow All-Round Light	1154 ME1 GAL	360°	2	342 002 CLR	6.7

**CERTIFIED FOR USE ON VESSELS OVER 20 METERS (65.6 FT.) IN LENGTH.**

Red Side Light	1150 RE2 GAL	112-1/2°	3	342 004 CLR*	10.9
Green Side Light	1150 GE2 GAL	112-1/2°	3	342 004 CLR*	10.9
White Masthead Light	1151 E02 GAL	225°	6	342 004 CLR*	10.0
White Stern Light	1152 E02 GAL	135°	3	342 002 CLR	9.5
White All-Round Light	1153 E02 GAL	360°	3	342 003 CLR	10.6
Red All-Round Light	1154 RE2 GAL	360°	3	342 006 CLR	10.6
Green All-Round Light	1154 GE2 GAL	360°	3	342 004 CLR*	10.6

\*342 RS4 CLR Bulbs can be substituted for 342 004 CLR where "Rough Service" bulbs are required



**FIG. 1150**



**FIG. 1151**



**FIG. 1152**



**FIG. 1153**



**FIG. 1154**

#### IMPORTANT BULB DATA

To comply with U.L. Standard 1104, the lights listed on this page must use a PERKO Cat. No. 342 bulb. (See Page 60)

#### Spare Lenses:

112-1/2°	Cat. No. 259 No. 1 or 2, Specify Color.
135°	Cat. No. 269 No. 1 or 2, Specify Color.
225°	Cat. No. 256 No. 1 or 2, Specify Color.
360°	Cat. No. 261F No. 1 or 2, Specify Color.

#### SPARE PARTS ORDERING INFORMATION

Spare Medium Prefocus Socket, Cat. No. 347 A00.
Spare Access Cap, O-Ring and Retainer, Cat. No. 1105 000 BLK.
Spare O-Ring for Cap, Cat. No. 1119.
Spare Socket Supports, Cat. Nos. 341 001 PLB & 341 01A PLB.



## NAVIGATION LIGHTS

**FIGS. 4, 5 & 7 - CERTIFIED FOR USE ON VESSELS  
20 METERS (65.6 FT.) TO 50 METERS (164.0 FT.) IN LENGTH**



### CONSTRUCTION:

- \* SHEET METAL, PREPRIMED GALVANIZED STEEL, POLISHED OR CHROME PLATED BRASS
- \* BOTTOM OPENING, COMPLETE WITH MOUNTING BRACKET
- \* SINGLE CONTACT PREFOCUS SOCKET FOR 12 VOLT USE ONLY
- \* 12 VOLT BULB NOT INCLUDED

Height Overall Inches	Height Lens Inches
8-1/2	5-3/16

### ORDERING INFORMATION

Description	Galvanized Steel	Polished Brass	Chrome Plated Brass	Visibility Arc	Visibility Miles	Required Bulb	Ship Wt. Carton Lbs. Std. Pkg.
Red Side Light	4 RD3 GAL	4 RD3 POL	4 RD3 CHR	112-1/2°	2	373 003 CLR	2.7
Green Side Light	4 GD3 GAL	4 GD3 POL	4 GD3 CHR	112-1/2°	2	373 002 CLR	2.7
White Masthead Light	5 D03 GAL	5 D03 POL	5 D03 CHR	225°	5	373 005 CLR	2.9
White Stern Light	7 D03 GAL	7 D03 POL	7 D03 CHR	135°	2	373 001 CLR	2.8
Yellow Towing Light	7 MD3 GAL	7 MD3 POL	7 MD3 CHR	135°	2	373 002 CLR	2.8

Navigation Lights for Vessels Over 20 Meters



**FIG. 4**



**FIG. 5**



**FIG. 7 & 7M**



### IMPORTANT BULB DATA

To comply with U.L. Standard 1104, the lights listed on this page must use a PERKO Cat. No. 373 bulb. (See Page 60)

### SPARE PARTS ORDERING INFORMATION

#### Spare Lenses:

Red,	112-1/2°	Cat. No. 259 CL3 RED.
Green,	112-1/2°	Cat. No. 259 CL3 GRN.
White,	135°	Cat. No. 269 CL3 WHT.
Yellow,	135°	Cat. No. 269 CL3 YLW.
Gray,	225°	Cat. No. 256 CL3 WHT.

Spare Mounting Bracket; Cat. No. 131 000 GAL or PLB.  
Spare Single Contact Prefocus Socket Assembly, Complete with Stand, Bottom Plate and Gasket, Cat. No. 294 003 PLB.

## SPECIAL PURPOSE LIGHTS

**FIG. 1111 - CERTIFIED FOR USE ON VESSELS OF ANY LENGTH**



- CONSTRUCTION:**
- \* SHEET METAL, PREPRIMED GALVANIZED STEEL
  - \* COMPLETE WITH MEDIUM PREFOCUS SOCKET
  - \* WATERTIGHT TERMINAL TUBE FOR 16/3-SO CABLE
  - \* SEALED FLASHER UNIT
  - \* WATERTIGHT ACCESS CAP FOR REBULBING AND CLEANING
  - \* 120 VOLT BULB NOT INCLUDED

Designed to meet Federal Requirements for Flashing yellow 180° - 225° light for barges, canal boats, etc., that are being pushed ahead or towed along side of a tug boat. For use on 120 volts A.C. only. Federal Requirements for this light are applicable for: inland waters, the Atlantic, Pacific and Gulf coasts, intercoastal waterways and western rivers. Refer to the U.S. Inland Navigation Rules for application, configuration and technical details.



**FIG. 1111ME**

### ORDERING INFORMATION

Catalog No. Standard Pkg. 1 Pc.	Height Overall Inches	Height Lens Inches	Visibility Miles	Visibility Arc	Flashes Per Minute	Ship Wt. Carton Lbs. Std. Pkg.
1111 ME1 GAL	11-1/2	6-3/4	2	225°	50-70	6.1

**IMPORTANT BULB DATA**

To comply with Federal Requirements this light must use a PERKO Cat. No. 342 004 CLR bulb or 342 RS4 CLR Bulbs when "Rough Service" bulbs are required

**SPARE PARTS ORDERING INFORMATION**

Spare Flasher, Cat. No. 133. Spare Medium Prefocus Socket, Cat. No. 347 A00.  
Spare O-Ring for Cap, Cat. No. 1119. Spare Access Cap, O-Ring and Retainer, Cat. No. 1105 000 BLK.  
Spare Lens, Cat. No. 256 001 YLW.

Navigation Lights for Vessels Over 20 Meters

**FIG. 1129 - PANAMA CANAL BLUE STEERING LIGHT**

**CERTIFIED FOR USE ON VESSELS OF ANY LENGTH**



**CONSTRUCTION:**

- \* BLACK PLASTIC
- \* PRE-WIRED DOUBLE CONTACT SOCKET WITH 3 FEET OF 16/3-SJO CABLE
- \* FOR 12, 24, 32 OR 120 VOLTS, BULB NOT INCLUDED



**FIG. 1129BA**

### ORDERING INFORMATION

Catalog No. Std. Pkg. - 1 Pc.	Visibility Arc	Height Overall Inches	Height Lens Inches	Ship Wt. Carton Lbs. Standard Pkg.
1129 BAO BLK	135°	7-1/2	4-1/2	2.9

**IMPORTANT BULB DATA**

To comply with Panama Canal Requirements this light must use a PERKO Fig. No. 374 bulb.

**SPARE PARTS ORDERING INFORMATION**

12 Volts, Cat. No. 374 001 CLR. Spare Lens, Cat. No. 249 000 BLU.  
24 Volts, Cat. No. 374 002 CLR. Spare O-Ring for Cap, Cat. No. 1119.  
32 Volts, Cat. No. 374 003 CLR. Spare Double Contact Socket, Cat. No. 134.  
120 Volts, Cat. No. 374 004 CLR. Spare Plastic Cap, O-Ring and Retainer, Cat. No. 1105 000 BLK.

**FIG. 454 - ALL-ROUND WHITE WHISTLE LIGHT**

**CERTIFIED FOR USE ON VESSELS OVER 20 METERS (65.6 FT.) IN LENGTH**



**CONSTRUCTION:**

- \* CAST BRONZE
- \* COMPLETE WITH MEDIUM PREFOCUS SOCKET
- \* 120 VOLT BULB NOT INCLUDED



**FIG. 454E**

### ORDERING INFORMATION

Catalog No. Std. Pkg. - 1 Pc.	Ht. Overall Inches	Ht. Lens Inches	Tapped Pipe Size Inches	Ship Wt. Carton Lbs. Standard Pkg.	Visibility Miles
454 E00 PLB	11-1/2	6-3/4	1	8.6	5

**SPARE PARTS ORDERING INFORMATION**

Spare Bulb, Cat. No. 342 004 CLR. Spare Lens or Cover Gasket, Cat. No. 1143.  
Spare Lens, Cat. No. 261 001 CLR. Spare Medium Prefocus Socket, Cat. No. 367.

## SPECIALTY ALL-ROUND LIGHTS

**FIGS. 403 & 412 - CERTIFIED FOR USE ON VESSELS  
OVER 20 METERS (65.6 FT.) IN LENGTH**



**CONSTRUCTION:**

- \* **CAST BRONZE**
- \* **COMPLETE WITH MEDIUM PREFOCUS SOCKET**
- \* **120 VOLT BULB NOT INCLUDED**

Fig. No.	Height Overall Inches	Height Lens Inches	Tapped Pipe Size Inches	Ship Wt. Carton Lbs. Std. Pkg.	Visibility Miles
403	11-1/2	6-3/4	1	8.8	3
412	14	6-3/4	*	9.1	3



**Fig. 403-3**



**Fig. 412**

Navigation Lights for Vessels Over 20 Meters

**ORDERING INFORMATION**

	White	Red	Green	Yellow
Fig. No. 403	403 E03 PLB**	403 RE3 PLB	403 GE3 PLB	403 ME3 PLB
Fig. No. 412	412 E00 PLB**	412 RE0 PLB	412 GE0 PLB	412 ME0 PLB

\*Supplied with watertight terminal tube for 16/3-SO cable.  
\*\*These Lights are Supplied with Gray Tinted Lenses.

**IMPORTANT BULB DATA**

To comply with U.L. Standard 1104, the lights listed on this page must use a PERKO Cat. No. 342 004 CLR bulb.

**SPARE PARTS ORDERING INFORMATION**

Spare Lenses:  
 Gray, Cat. No. 261 001 GRY.      Spare Lens or Cover Gasket, Cat. No. 1143.  
 Red, Cat. No. 261 001 RED.      Spare Medium Prefocus Socket, Cat. No. 367.  
 Green, Cat. No. 261 001 GRN.  
 Yellow, Cat. No. 261 001 YLW.

**FIG. 112 - CERTIFIED FOR USE ON VESSELS  
20 METERS (65.6 FT.) TO 50 METERS (164.0 FT.) IN LENGTH**



**CONSTRUCTION:**

- \* **CAST BRONZE, PLAIN OR CHROME PLATED**
- \* **COMPLETE WITH DOUBLE CONTACT ELECTRICAL SOCKET**
- \* **12, 24, 32 OR 120 VOLTS. BULB NOT INCLUDED**



**Fig. 309A**

Fig. No.	Height Overall Inches	Diameter Base Inches	Tapped Pipe Size Inches	Ship Wt. Carton Lbs. Std. Pkg.	Visibility Miles
112	8-3/4	3-1/8	-----	2.3	2
309	6-1/2	-----	1/2	1.7	2



**Fig. 112A**

**ORDERING INFORMATION**

**ORDERING INFORMATION**

Description	Plain Bronze		Chrome Plated Bronze		
	Plain Bronze	Chrome Plated Bronze	Plain Bronze	Chrome Plated Bronze	
White All-Round	112 A00 PLB	112 A00 CHR	White All-Round	309 A00 PLB	309 A00 CHR
Red All-Round	112 RA0 PLB	112 RA0 CHR	Red All-Round	309 RA0 PLB	309 RA0 CHR
Green All-Round	112 GA0 PLB	112 GA0 CHR	Green All-Round	309 GA0 PLB	309 GA0 CHR
Yellow All-Round	112 MA0 PLB	112 MA0 CHR	Yellow All-Round	309 MA0 PLB	309 MA0 CHR

**IMPORTANT BULB DATA**

To comply with U.L. Standard 1104, the lights listed on this page must use a PERKO Cat. No. 374 bulb.

**SPARE PARTS ORDERING INFORMATION**

Spare Lenses:  
 Red, Cat. No. 106 000 RED.  
 Green, Cat. No. 106 000 GRN.  
 White, Cat. No. 106 000 WHT.  
 Yellow, Cat. No. 106 000 YLW.  
 Spare Double Contact Bayonet Socket, Cat. No. 276 002.

Required Bulbs:  
 12 Volts, Cat. No. 374 001 CLR.  
 24 Volts, Cat. No. 374 002 CLR.  
 32 Volts, Cat. No. 374 003 CLR.  
 120 Volts, Cat. No. 374 004 CLR.

FOR NAVIGATION LIGHTS ON VESSELS OVER 20 METERS (65.6 FT.) IN LENGTH

### DUAL MEDIUM PREFOCUS SOCKET ASSEMBLY



Phenolic - 250 Volts - 1000 Watts  
Plug In Type - Prewired - with two medium  
prefocus sockets. For use in double lens lights.

Cat. No.	Height Overall Inches	Width Overall Inches	Weight Ounces
303	3-7/8	3-7/8	9

Male Plug Only Cat. No. 303 A00. Female Socket Only Cat. No. 303 B00.

### MEDIUM PREFOCUS SOCKETS



Phenolic - 250 Volts - 1000 Watts

Cat. No.	Height Overall Inches	Diameter Overall Inches	Std. Package	Weight Per Pkg. Ounces
367	1-7/8	1-1/2	5	21-1/2
347 A00*	1-7/8	1-1/2	5	21-1/2

\* Cat. No. 347 A00 (Pictured) Supplied with metal Mounting Cap Tapped for 3/8 Inch I.P.S.

### SINGLE CONTACT PREFOCUS SOCKET ASSEMBLY - COMPLETE WITH STAND, BOTTOM PLATE AND GASKET



Cat. No.	Height Overall Inches	Diameter Overall Inches
294 003 PLB	3	3-3/4

### DOUBLE CONTACT SOCKET



Cat. No.	Height Overall Inches	Diameter Overall Inches
134	7/8	1-3/4

### 112-1/2° LENSES



Color	Ht. Inches	Width Inches	Std. Pkg. - 1 Pc.
Red	4-1/4	3-1/16	259 CL2 RED
Green	4-1/4	3-1/16	259 CL2 GRN
Red	5-1/16	3-11/16	259 CL3 RED
Green	5-1/16	3-11/16	259 CL3 GRN



Color	Height Overall Inches	Dia. Opening Inches	Catalog Number
Red	6-3/4	6-1/8	259 001 RED
Green	6-3/4	6-1/8	259 001 GRN
Red	7-1/2	9-1/4	259 002 RED
Green	7-1/2	9-1/4	259 002 GRN

Weight Size 1, .5 Lbs. - Weight Size 2, 1.2 Lbs  
Weight Size 3, 1.5 Lbs

### 135° LENSES



Color	Height Inches	I.D. Inches	Std. Pkg. - 1 Pc.
White	4-1/4	3-1/2	269 CL2 WHT
White	5-1/8	3-5/8	269 CL3 WHT
Yellow	4-1/4	3-1/2	269 CL2 YLW
Yellow	5-1/8	3-5/8	269 CL3 YLW

Color	Height Overall Inches	Dia. Opening Inches	Catalog Number
White	6-3/4	5-1/8	269 001 WHT
Red	6-3/4	5-1/8	269 001 RED
Yellow	6-3/4	5-1/8	269 001 YLW
White	7-1/2	7-1/4	269 002 WHT
Red	7-1/2	7-1/4	269 002 RED

Weight Size 1, .9Lbs - Weight Size 2, 1.2 Lbs oz. Weight Size 3, 1.5 Lbs

### 360° LENSES



Color	Height Overall Inches	Diameter Opening Inches	Clear Cat. No.	Frosted Cat. No.
White	6-3/4	5-1/8	261 001 CLR	261 001 FRD
Red	6-3/4	5-1/8	261 001 RED	261 RF1 FRD
Green	6-3/4	5-1/8	261 001 GRN	261 GF1 FRD
Yellow	6-3/4	5-1/8	261 001 YLW	261 MF1 FRD
Gray	6-3/4	5-1/8	261 001 GRY	-----
White	7-1/2	7-3/8	261 002 CLR	261 002 FRD
Red	7-1/2	7-3/8	261 002 RED	261 RF2 FRD
Green	7-1/2	7-3/8	261 002 GRN	261 GF2 FRD

Weight Size 1, 13.5 oz. - Weight Size 2, 43 oz.

### 225° LENSES



Color	Ht. Inches	I.D. Inches	Std. Pkg. - 1 Pc.
White	4-1/4	3-3/8	256 CL2 WHT
White	5-1/8	3-1/4	256 CL3 WHT

Color	Ht. Overall Inches	Dia. Opening Inches	Catalog Number
White	6-3/4	4-1/2	256 001 WHT
Yellow	6-3/4	4-1/2	256 001 YLW
White	7-1/2	6-5/8	256 002 WHT

Weight Size 1, 1.2 Lbs - Weight Size 2, 1.7 Lbs.,  
Weight Size 3, 1.8 Lbs.

### 360° LENSES



Color	Height Inches	I.D. Inches	O.D. Inches	Std. Pkg. - 1 Pc.
Red	5	2-7/8	3-1/4	106 000 RED
Green	5	2-7/8	3-1/4	106 000 GRN
White	5	2-7/8	3-1/4	106 000 WHT
Yellow	5	2-7/8	3-1/4	106 000 YLW
Gray	5	2-7/8	3-1/4	106 000 GRY

### 360° LENSES - With Top Assembly



Color	Ht. Overall Inches	Dia. Opening Inches	Catalog Number
White	5-3/4	5-1/2	249 000 CLR
Red	5-3/4	5-1/2	249 000 RED
Green	5-3/4	5-1/2	249 000 GRN
Yellow	5-3/4	5-1/2	249 000 YLW
Gray	5-3/4	5-1/2	249 000 GRY

Weight 17 oz.

### SINGLE CONTACT PREFOCUS BULBS



Cat. No.	C-8 Filament Clear - 12 Volts Amperage	Mfg. No.
373 001 CLR	.25	25A/S8
373 002 CLR	.55	55A/S8
373 003 CLR	.77	77A/S8
373 004 CLR	1.15	1.15A/S8
373 005 CLR	2.03	2.03A/S8SCP

Weight 1 oz. - Standard Pkg. - 1 pc.

### MEDIUM PREFOCUS BULBS

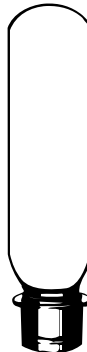

Cat. No.	Clear Volts	Wattage
342 000 CLR	120	7.5
342 001 CLR**	120	15
342 002 CLR**	120	25
342 003 CLR**	120	40
342 024 CLR	24	55
342 004 CLR**	120	60
342 RS4 CLR*	120	60
342 006 CLR	120	125
342 220 CLR	220	65

Weight 1 oz. - \* Designed for rough service.  
Standard Pkg. - 1 pc. - \*\*OEM - 25 pcs.

### DOUBLE CONTACT BAYONET BULBS

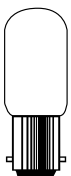

Clear - 12, 24, 32 or 120 Volts,  
Type T-8, C-8, Filament - 1-3/8 Inch L.C.L.

Cat. No.	Voltage	Wattage	Candella
374 001 CLR	12	30	24
374 002 CLR	24	30	24
374 003 CLR	32	30	24
374 004 CLR	120	30	24

Weight 1 oz. - Standard Pkg. - 1 pc.

Navigation Lights for Vessels Over 20 Meters

## SEARCHLIGHTS

### *FIGS. 534, 535 & 538 - SEARCHLIGHTS*

#### **CONSTRUCTION:**

- \* **CHROME PLATED BRASS HEAD**
- \* **FOR 12, 24 OR 32 VOLTS**
- \* **TUNGSTEN OR HALOGEN**
- \* **SWITCH IN HEAD**

#### **FIG. 534 - DECK CONTROL.**

- \* **CHROME PLATED BRONZE BASE**
- \* **7 INCH SEALED BEAM BULB**

#### **FIG. 535 - PILOT HOUSE CONTROL SEARCHLIGHT**

- \* **CHROME PLATED BRONZE BASE**
- \* **7 INCH SEALED BEAM BULB**
- \* **LEVER HANDLE CONTROLS BOTH HORIZONTAL AND VERTICAL MOVEMENT**
- \* **CONTROL LENGTH: 7-1/2 INCHES**
- \* **MAXIMUM CEILING THICKNESS: 4-1/2 INCHES**

#### **FIG. 538 - DECK CONTROL**

- \* **CHROME PLATED BRASS BASE**
- \* **4-1/2 INCH SEALED BEAM BULB**



**FIG. 534**



**FIG. 535**



**FIG. 538**

#### **ORDERING INFORMATION**

Voltage	O.D. Bulb Inches	Approx. Range Miles	Beam Candlepower	Wattage	Height Overall Inches	Base Dimension Inches	Catalog Number	Ship Wt. Carton Lbs. Std Pkg.
12	7	5/8	250,000	100	12-1/2	4-7/8 x 3-1/8	534 003 12V	8.1
24	7	3/4	470,000	450	12-1/2	4-7/8 x 3-1/8	534 003 24V	7.8
32	7	5/8	260,000	200	12-1/2	4-7/8 x 3-1/8	534 003 32V	8.0
12	7	5/8	250,000	100	-----	4-7/8 x 3-1/8	535 003 12V	8.8
24	7	3/4	470,000	450	-----	4-7/8 x 3-1/8	535 003 24V	8.8
32	7	5/8	260,000	200	-----	4-7/8 x 3-1/8	535 003 32V	8.7
12	4-1/2	1/4	50,000	30	7-1/2	3-1/2 O.D.	538 000 CHR	1.4
12	4-1/2	1/3	100,000	50	7-1/2	3-1/2 O.D.	538 H00 CHR*	1.4

\*NOTE: "H" in the Catalog Number Designates a Halogen Bulb.

### *FIG. 440 - REMOVABLE DECK CONTROL SEARCHLIGHT*

#### **CONSTRUCTION:**

- \* **CHROME PLATED BRASS HEAD AND BASE**
- \* **FOR 12 OR 32 VOLTS**
- \* **4-1/2 OR 7 INCH SEALED BEAM BULB**
- \* **8 FEET OF COILED CORD & CIGARETTE LIGHTER PLUG**
- \* **WATERTIGHT DECK CONNECTION. SWITCH IN HEAD**

#### **ORDERING INFORMATION**

Voltage	O.D. Bulb Inches	Approx. Range Miles	Beam Candlepower	Wattage	Height Overall Inches	Catalog Number	Ship Wt. Carton Lbs. Std Pkg.
12	4-1/2	1/4	50,000	30	7-1/2	440 001 12V	2.4
12	4-1/2	1/3	100,000	50	7-1/2	440 H01 12V*	2.4
12	7	5/8	250,000	100	10	440 003 12V	5.4
32	7	5/8	260,000	200	10	440 003 32V	5.3



**FIG. 440**

Base Diameter, 2-1/8 Inches.

\*NOTE: "H" in the Catalog Number Designates a Halogen Bulb.

#### **SPARE SEALED BEAM ORDERING INFORMATION**

Spare 4-1/2 Inch Sealed Beam Unit, Cat. No. 433 001 12V.  
Spare 4-1/2 Inch Halogen Sealed Beam Unit, Cat. No. 435 001 12V.

Spare 7 Inch Sealed Beam Unit (12 Volt), Cat. No. 433 003 12V.  
Spare 7 Inch Sealed Beam Unit (24 Volt), Cat. No. 433 003 24V.  
Spare 7 Inch Sealed Beam Unit (32 Volt), Cat. No. 433 003 32V.

**FIG. 314 - PILOT HOUSE CONTROL SEARCHLIGHT**

**FIG. 314 CHROME**



- CONSTRUCTION:**
- \* CHROME PLATED OR WHITE POWDER COATED BRASS
  - \* CORROSION RESISTANT, SPLASH PROOF CONSTRUCTION
    - \* 7 & 8 INCH SEALED BEAM UNITS
  - \* TIN PLATED ELECTRICAL CONTACTS AND WIRING
    - \* LEVER ACTION, PILOT HOUSE CONTROL
  - \* 380° HORIZONTAL MOVEMENT, 70° VERTICAL MOVEMENT
    - \* LEVER HANDLE CONTROLS BOTH HORIZONTAL AND VERTICAL MOVEMENT
    - \* FOR CEILING THICKNESSES OF UP TO 5"

**FIG. 314 STANDARD**

- \* FOR 12, 24 OR 32 VOLTS

**FIG. 314 H.I.D.**

- \* HIGH INTENSITY DISCHARGE TECHNOLOGY
  - \* FOR 12 VOLT SYSTEMS ONLY
- \* GREATER INTENSITY AND BEAM UNIFORMITY THAN CONVENTIONAL SEALED BEAM SEARCHLIGHTS
  - \* FIVE TIMES THE TARGET RESOLVING POWER THAN CONVENTIONAL SEALED BEAMS
- \* LOW POWER CONSUMPTION, APPROXIMATELY 4 AMPS AT 12 VOLTS
  - \* FIVE YEAR LAMP WARRANTY

**FIG. 314 WHITE**



**ORDERING INFORMATION**

Overall Length	Approx. Voltage	Approx. Range Miles	Beam Candle Power	Wattage	Chrome Catalog Number	White Catalog Number	Ship Wt. Carton Lbs. Std. Pkg.
<b>7 Inch Head</b>							
<b>Standard</b>							
24	12	5/8	250,000	100	314 C07 12V	314 W07 12V	12.6
24	24	3/4	470,000	450	314 C07 24V	314 W07 24V	12.8
24	32	5/8	260,000	200	314 C07 32V	314 W07 32V	13.8
<b>H.I.D.</b>							
24	12	1	-----	35	314 CH7 12V	314 WH7 12V	12.8
<b>8 Inch Head</b>							
<b>Standard</b>							
26	12	3/4	500,000	250	314 C08 12V	314 W08 12V	13.6
26	24	3/4	500,000	600	314 C08 24V	314 W08 24V	14.1
26	32	3/4	500,000	600	314 C08 32V	314 W08 32V	15.0

**Sealed Beam Information**

Replacement Sealed Beam Unit For 7 Inch Head, 12 Volt, Cat. No. 433 003 12V  
 Replacement Sealed Beam Unit For 7 Inch Head, 24 Volt, Cat. No. 433 003 24V  
 Replacement Sealed Beam Unit For 7 Inch Head, 32 Volt, Cat. No. 433 003 32V

Replacement Sealed Beam Unit For 8 Inch Head, 12 Volt, Cat. No. 433 004 12V  
 Replacement Sealed Beam Unit For 8 Inch Head, 24 Volt, Cat. No. 433 004 24V  
 Replacement Sealed Beam Unit For 8 Inch Head, 32 Volt, Cat. No. 433 004 32V\*

\*Used in conjunction with Internal Dropping Resistor (Cat. No. 314 R32 99A).

## SOLAR-RAY® SEALED BEAM SEARCHLIGHTS

**BRONZE BASE, BRASS BODY**  
**POLISHED CHROME PLATED OR WHITE PERKO•KOTE POWDER COATING**  
**FOR 12, 24 OR 32 VOLTS**

### DIMENSIONS (INCHES)

"A"	"B"	"C"	"D"	"G"	"H"
8	8-1/2	10	7	2	2-1/8

### ELECTRICAL SPECIFICATIONS

Voltage	Wattage	Approximate Candlepower	Sealed Beam Range Miles	Spare Bulb Catalog No.
12	100	250,000	5/8	433 003 12V
24	450	470,000	3/4	433 003 24V
32	200	260,000	5/8	433 003 32V

### FIGS. 305 & 313 - SEARCHLIGHT HEADS

#### ORDERING INFORMATION

Voltage	Head Only Polished Chrome For Lever Control Cat. No.	Head Only White PERKO•KOTE For Lever Control Cat. No.	Head Only Polished Chrome For Wheel or Lever/Gear Control Cat. No.	Head Only White PERKO•KOTE For Wheel or Lever/Gear Control Cat. No.
12	305 H12 CHR	305 H12 WHT	313 H12 CHR	313 H12 WHT
24	305 H24 CHR	305 H24 WHT	313 H24 CHR	313 H24 WHT
32	305 H32 CHR	305 H32 WHT	313 H32 CHR	313 H32 WHT

Nominal Weight - 20 lbs.

Fig. 354 Spare Front Bezel with Glass for Figs. 305 & 313, Specify Chrome or White.  
 Fig. 355 Spare Rear Cover for Figs. 305 & 313, Specify Chrome or White.



FIG. 313



FIG. 305

### FIGS. 851, 852 & 969 - CONTROL ASSEMBLIES

#### STAINLESS STEEL TUBES WITH CHROME PLATED FITTINGS

Note: Lever Control (Fig. 851) Fits Fig. 305 Head Assemblies.  
 Wheel Control (Fig. 852) and Lever/Gear Control (Fig. 969) Fit Fig. 313 Head Assemblies.

#### ORDERING INFORMATION

Control Length Inches	"E"	"E"	"F"	Nominal Weight Pounds	
"E"	Lever Control Cat. No.	Lever/Gear Control Cat. No.	Wheel Control Cat. No.		
8-1/2	7-1/2	851 000*	969 000**	852 000***	6
15-1/2	14-1/2	851 0A0	969 0A0	852 0A0	9
22-1/2	21-1/2	851 0B0	969 0B0	852 0B0	12
29-1/2	28-1/2	851 0C0	969 0C0	852 0C0	15

\*Maximum Ceiling Thickness, 4-1/2 Inches.  
 \*\*Maximum Ceiling Thickness, 3-1/2 Inches.  
 \*\*\*Maximum Ceiling Thickness, 3 Inches.  
 Custom Lengths Available by Special Order.

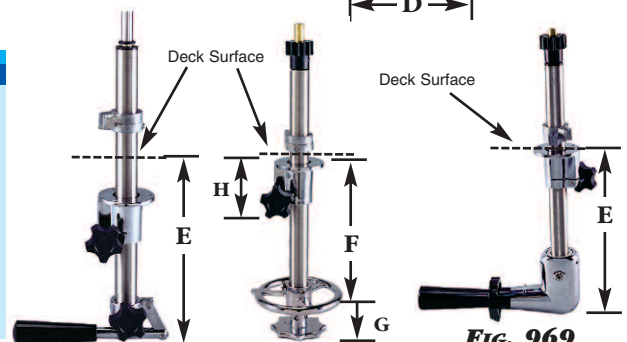

FIG. 851  
LEVER CONTROL  
FITS 305 HEAD

FIG. 852  
WHEEL CONTROL  
FIT 313 HEAD

FIG. 969  
LEVER/GEAR CONTROL  
FIT 313 HEAD

## SOLAR-RAY® SEARCHLIGHTS

**800 SERIES**  
10", 12" OR 14"

**CAST BRONZE AND HEAVY GAUGE BRASS**  
**POLISHED CHROME OR WHITE PERKO•KOTE FINISH**  
**12, 24, 32, 120 OR 230 VOLTS**

The 800 Series - Solar-Ray® Searchlights are available in 10", 12" and 14" sizes with your choice of Deck, Wheel, Lever/Gear Controls or DEC on 14 Inch Model. All models feature: halo deflectors, parabolic glass mirror reflectors for maximum light output and ventilation covers for quick dissipation of heat to help prolong bulb life. Hinged front doors have quick release stainless steel latches to provide easy access for bulb replacement. The 800 Series models are also available in our white PERKO•KOTE finish, an advanced powder coating process that eliminates the need for painting while providing a scratch resistant and chip-proof surface for painting when necessary to match the color of the vessel.

**Bulbs are not included and must be ordered separately.** PERKO offers a choice of the traditional incandescent or the brighter, more piercing quartz-halogen bulbs in a broad variety of voltages and wattages to fit every need. For complete information on bulbs and candlepower output, see pages 72 & 73 .

Searchlights



**"800 SERIES" High Power Searchlight Features**

**CONTROL TYPES**

**DECK CONTROL**

Equipped with handles on the rear cover for positioning.

**LEVER CONTROL**

Aim handle for horizontal position. Move handle up and down for vertical position.



**WHEEL CONTROL**

Turn upper wheel for horizontal position. Turn lower wheel for vertical position.



**LEVER/GEAR CONTROL**

Aim handle for horizontal position. Twist handle for vertical position.

**DISTANT ELECTRIC CONTROL**  
Joystick type controller for both horizontal & vertical positioning  
(Only Available on the 887)

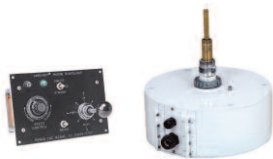

**FIG. 887**

**BULBS ARE NOT INCLUDED IN LIGHTS**



## DISTANT ELECTRIC CONTROL SOLAR-RAY® SEARCHLIGHTS

### 887 SERIES

FOR 12, 24 & 120 VOLT

#### SEARCHLIGHT DIMENSIONS

Nominal Drum Diameter Inches	Length Drum Inches	Gross Shipping Weight Pounds
14	17	68



#### REMOTE ELECTRIC

Joystick type controller with variable speed control for both horizontal & vertical positioning



**FIG. 887 - STANDARD PEDESTAL WITH DEC BASE**

**ALL ALUMINUM - WHITE PERKO•KOTE FINISH**

#### ORDERING INFORMATION

Description	Catalog No.
Searchlight Head Assembly w/ Distant Electric Control Base - 12 Volt	887 EA3 WHT
Searchlight Head Assembly w/ Distant Electric Control Base - 24 Volt	887 EB3 WHT
Searchlight Head Assembly w/ Distant Electric Control Base - 120 Volt	887 EC3 WHT

**BULBS ARE NOT INCLUDED IN LIGHTS (SEE PAGES 72 & 73)**

Searchlights

### 883 SERIES

10", 12" OR 14"

#### SEARCHLIGHT DIMENSIONS

"A" Nominal Drum Diameter Inches	"C" Length Drum Inches	Nominal Weight Pounds
10	13	28
12	15	38
14	17	45



**FIG. 883 - STANDARD PEDESTAL  
CHROME**



**FIG. 883 - HIGH PEDESTAL  
CHROME**



**FIG. 883 - MEDIUM PEDESTAL  
WHITE**

\* Note: The "J" Dimension is Height Overall.

**BULBS ARE NOT INCLUDED IN LIGHTS (SEE PAGES 72 & 73)**

## DECK CONTROL SOLAR-RAY® SEARCHLIGHTS

### 883 SERIES

10", 12" OR 14"

#### ORDERING INFORMATION

- NOTES: 1) These Searchlights Cannot Be Fitted With Controls.  
 2) Bulbs Must be Ordered Separately, Refer to Pages 72 and 73 for Ordering Information.  
 3) Refer to Worksheet on Page 74 For Help in Ordering.

#### STANDARD PEDESTAL SEARCHLIGHTS

Nominal Reflector Size Inches	"J" Height Overall Inches	Polished Chrome Catalog No.	White PERKO•KOTE Catalog No.
10	20-1/8	883 0P1 CHR	883 0P1 WHT
12	22-1/8	883 0P2 CHR	883 0P2 WHT
14	25-1/8	883 0P3 CHR	883 0P3 WHT

Standard Pedestal Base Diameter, 7 Inches.

#### MEDIUM PEDESTAL SEARCHLIGHTS

Nominal Reflector Size Inches	"J" Height Overall Inches	Polished Chrome Catalog No.	White PERKO•KOTE Catalog No.
10	27-1/2	883 MP1 CHR	883 MP1 WHT
12	29-1/2	883 MP2 CHR	883 MP2 WHT
14	32-1/2	883 MP3 CHR	883 MP3 WHT

Medium Pedestal Base Diameter, 8 Inches.

#### HIGH PEDESTAL SEARCHLIGHTS

Nominal Reflector Size Inches	"J" Height Overall Inches	Polished Chrome Catalog No.	White PERKO•KOTE Catalog No.
10	44	883 HP1 CHR	883 HP1 WHT
12	46	883 HP2 CHR	883 HP2 WHT
14	49	883 HP3 CHR	883 HP3 WHT

High Pedestal Base Diameter, 8 Inches.

**NOTE: Custom Pedestal Heights are Available.  
 Price Upon Application.  
 Specify the "J" Dimension for Custom Pedestal Height.**

**High Pedestal White**



**Med. Pedestal White**



**Std. Pedestal White**



**Std. Pedestal Chrome**



**Med. Pedestal Chrome**



**High Pedestal Chrome**



### 884 SERIES

10", 12" AND 14"

#### SEARCHLIGHT DIMENSIONS

"A" Nominal Drum Diameter Inches	"C" Length Drum Inches	Nominal Weight Pounds
10	13	28
12	15	38
14	17	45



**FIG. 884**  
**STANDARD PEDESTAL**



**FIG. 884**  
**MEDIUM PEDESTAL**



**FIG. 884**  
**HIGH PEDESTAL**

\* Note: The "J" Dimension is height from mounting surface to the top of the light.

**BULBS ARE NOT INCLUDED IN LIGHTS (SEE PAGES 72 & 73)**

## LEVER CONTROL SOLAR-RAY® SEARCHLIGHT HEAD ASSEMBLIES

### 884 SERIES

10", 12" AND 14"

#### ORDERING INFORMATION

- NOTES: 1) Bulbs Must be Ordered Separately, Refer to Pages 72 and 73 for Ordering Information.  
2) Refer to Worksheet on Page 74 For Help in Ordering.

#### STANDARD PEDESTAL SEARCHLIGHT HEAD ASSEMBLIES

Nominal Reflector Size Inches	"J" Height Inches	Polished Chrome Catalog No.	White PERKO•KOTE Catalog No.
10	20-1/8	884 0P1 CHR	884 0P1 WHT
12	22-1/8	884 0P2 CHR	884 0P2 WHT
14	25-1/8	884 0P3 CHR	884 0P3 WHT

Standard Pedestal Base Diameter, 7 Inches.

#### MEDIUM PEDESTAL SEARCHLIGHT HEAD ASSEMBLIES

Nominal Reflector Size Inches	"J" Height Inches	Polished Chrome Catalog No.	White PERKO•KOTE Catalog No.
10	28-1/4	884 MP1 CHR	884 MP1 WHT
12	30-1/4	884 MP2 CHR	884 MP2 WHT
14	33-1/4	884 MP3 CHR	884 MP3 WHT

Medium Pedestal Base Diameter, 8 Inches.

#### HIGH PEDESTAL SEARCHLIGHT HEAD ASSEMBLIES

Nominal Reflector Size Inches	"J" Height Inches	Polished Chrome Catalog No.	White PERKO•KOTE Catalog No.
10	44-3/4	884 HP1 CHR	884 HP1 WHT
12	46-3/4	884 HP2 CHR	884 HP2 WHT
14	49-3/4	884 HP3 CHR	884 HP3 WHT

High Pedestal Base Diameter, 8 Inches.

**High Pedestal White**



**Med. Pedestal White**



**Std. Pedestal White**



**Std. Pedestal Chrome**



**Med. Pedestal Chrome**



**High Pedestal Chrome**



NOTE: Custom Pedestal Heights are Available. Price Upon Application. Specify the "J" Dimension for Custom Pedestal Height.

#### FIG. 851 - LEVER CONTROL ASSEMBLIES

Control assemblies of different lengths may be interchanged on Solar-Ray® searchlights (Fig. 884) of the same pedestal height. The following chart makes it possible to order and stock different lengths of these assemblies separately to offer a large variety of Solar-Ray® searchlights with a minimum of inventory.

#### ORDERING INFORMATION

"E" Length Control Inches	For Standard Pedestal Cat. No.	For Medium Pedestal Cat. No.	For High Pedestal Cat. No.	Nominal Weight Pounds
8-1/2	851 000*	851 M00*	851 H00*	6
15-1/2	851 0A0	851 MA0	851 HA0	9
22-1/2	851 0B0	851 MB0	851 HB0	12
29-1/2	851 0C0	851 MC0	851 HC0	15

NOTE: Custom Control Lengths are Available. Price Upon Application.

Specify the "E" Dimension for Custom Control Lengths.

\* Maximum Ceiling Thickness, 4-1/2 Inches.

### 885 SERIES

10", 12" AND 14"

#### SEARCHLIGHT DIMENSIONS

"A" Nominal Drum Diameter Inches	"C" Length Drum Inches	Nominal Weight Pounds
10	13	28
12	15	38
14	17	45

Searchlights

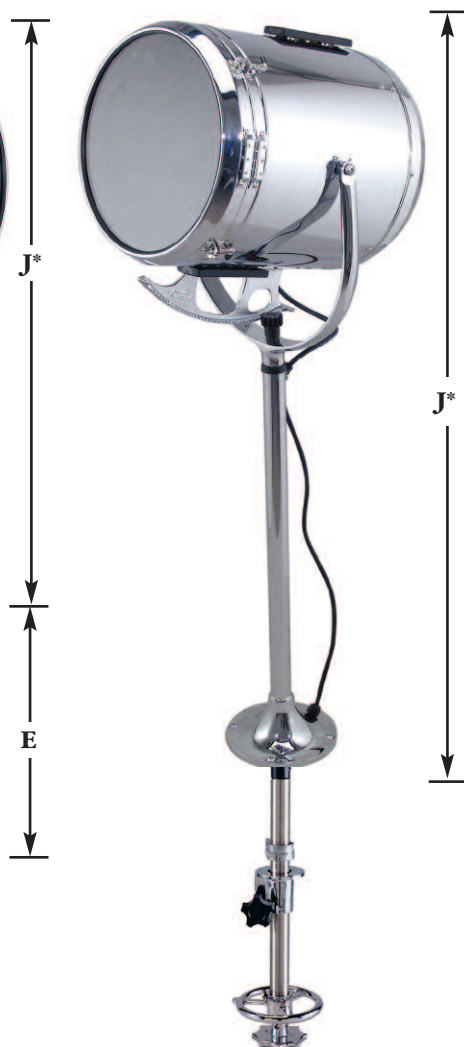

**FIG. 885**  
**STANDARD PEDESTAL**  
**SHOWN WITH WHEEL CONTROL**

"G" Distance Between Wheels, 2 Inches.



**FIG. 885**  
**MEDIUM PEDESTAL**  
**SHOWN WITH**  
**LEVER/GEAR CONTROL**



**FIG. 885**  
**HIGH PEDESTAL**  
**SHOWN WITH WHEEL CONTROL**

\* Note: The "J" Dimension is height from mounting surface to the top of the light.

**BULBS ARE NOT INCLUDED IN LIGHTS (SEE PAGES 72 & 73)**

## WHEEL OR LEVER/GEAR CONTROL SOLAR-RAY® SEARCHLIGHT HEAD ASSEMBLIES

### 885 SERIES

10", 12" AND 14"

#### ORDERING INFORMATION

- Notes: 1) Bulbs Must be Ordered Separately, Refer to Pages 72 and 73 for Ordering Information.  
2) Refer to Worksheet on Page 74 For Help in Ordering.

#### STANDARD PEDESTAL SEARCHLIGHT HEAD ASSEMBLIES

Nominal Reflector Size Inches	"J" Height Inches	Polished Chrome Catalog No.	White PERKO•KOTE Catalog No.
10	20-1/8	885 0P1 CHR	885 0P1 WHT
12	22-1/8	885 0P2 CHR	885 0P2 WHT
14	25-1/8	885 0P3 CHR	885 0P3 WHT

Standard Pedestal Base Diameter, 7 Inches.

#### MEDIUM PEDESTAL SEARCHLIGHT HEAD ASSEMBLIES

Nominal Reflector Size Inches	"J" Height Inches	Polished Chrome Catalog No.	White PERKO•KOTE Catalog No.
10	28-1/4	885 MP1 CHR	885 MP1 WHT
12	30-1/4	885 MP2 CHR	885 MP2 WHT
14	33-1/4	885 MP3 CHR	885 MP3 WHT

Medium Pedestal Base Diameter, 8 Inches.

#### HIGH PEDESTAL SEARCHLIGHT HEAD ASSEMBLIES

Nominal Reflector Size Inches	"J" Height Inches	Polished Chrome Catalog No.	White PERKO•KOTE Catalog No.
10	44-3/4	885 HP1 CHR	885 HP1 WHT
12	46-3/4	885 HP2 CHR	885 HP2 WHT
14	49-3/4	885 HP3 CHR	885 HP3 WHT

High Pedestal Base Diameter, 8 Inches.



NOTE: Custom Pedestal Heights are Available. Price Upon Application. Specify the "J" Dimension for Custom Pedestal Height.

#### CONTROL ASSEMBLIES - FIGS. 852 & 969

Control Assemblies of different lengths may be interchanged on Solar-Ray® searchlights (Fig. 885) of the same pedestal height. The following chart makes it possible to order and stock different lengths of these assemblies separately to offer a large variety of Solar-Ray® Searchlights with a minimum of inventory.

#### WHEEL CONTROL - FIG. 852

##### ORDERING INFORMATION

"F" Length Control Inches	For Standard Pedestal Cat. No.	For Medium Pedestal Cat. No.	For High Pedestal Cat. No.	Nominal Weight Pounds
7-1/2	852 000*	852 M00*	852 H00*	6
14-1/2	852 0A0	852 MA0	852 HA0	9
21-1/2	852 0B0	852 MB0	852 HB0	12
28-1/2	852 0C0	852 MC0	852 HC0	15

\*Maximum Ceiling Thickness, 3 Inches.

#### LEVER/GEAR CONTROL - FIG. 969

##### ORDERING INFORMATION

"E" Length Control Inches	For Standard Pedestal Cat. No.	For Medium Pedestal Cat. No.	For High Pedestal Cat. No.	Nominal Weight Pounds
8-1/2	969 000*	969 M00*	969 H00*	6
15-1/2	969 0A0	969 MA0	969 HA0	9
22-1/2	969 0B0	969 MB0	969 HB0	12
29-1/2	969 0C0	969 MC0	969 HC0	15

\*Maximum Ceiling Thickness, 3-1/2 Inches.

NOTE: Custom Control Lengths are Available. Price Upon Application. Specify the "E" or "F" Dimension for Custom Control Lengths.

### 800 SERIES - 10", 12" AND 14"

**BULBS ARE NOT INCLUDED IN LIGHTS AND MUST BE ORDERED SEPARATELY**

To give good results, the bulb and reflector must be perfectly compatible; therefore be sure to specify the catalog number of the bulb desired. Peak candlepower is exceedingly sensitive to many factors, (i.e., a light source out of focus by 1/32 inch, under-voltage of only 4%, or differences between bulb manufacturers) which can cause a variation in range of up to 20%.

#### INCANDESCENT BULB ORDERING INFORMATION

Bulb Catalog Number	Voltage	Wattage	Socket Type	Socket Code Letter	For Searchlight Sizes Inches	Rated* Life Hours	Mfg. Bulb Code
806	32	500	Medium Screw	B	10, 12, 14	50	DLT
807	120	500	Medium Prefocus	E	10, 12, 14	25	CZX
809	120	750	Medium Prefocus	E	12, 14	25	DDB
837	120	750	Medium Prefocus	E	12, 14	200	DGH
810	120	1000	Medium Prefocus	E	12, 14	25	DRS
811	120	1000	Mogul Screw	D	12, 14	50	DPT

For a More Concentrated Beam, Longer Range, Brighter Light and a Longer Life, We Recommend the Following Bulbs:

#### "QUARTZ" TUNGSTEN-HALOGEN BULB ORDERING INFORMATION

Bulb Catalog Number	Voltage	Wattage	Socket Type	Socket Code Letter	For Searchlight Sizes Inches	Rated* Life Hours	Mfg. Bulb Code
816	12	100	2-Pin Prefocus	F	10, 12, 14	50	FDT
836	24	150	2-Pin Prefocus	G	10, 12, 14	50	DZE-FDS
817	32	200	2-Pin Prefocus	H	10, 12, 14	200	G.E. 1945
844	120	500	Medium Prefocus	E	10, 12, 14	500	BTL
820	120	600	2-Pin Prefocus	I	10, 12, 14	75	DYS
845	120	750	Medium Prefocus	E	12, 14	200	BTP
839	120	900	2-Pin Prefocus	K	12, 14	75	BVA
846	120	1000	Medium Prefocus	E	12, 14	200	BTR
860	230	1000	Medium Prefocus	E	12, 14	950	FKD

**PLEASE ORDER CAREFULLY, BULBS ARE NOT RETURNABLE.**

**\*NOTE:** These are the "Rated Average Laboratory Life in Hours" of the Bulb Manufacturer obtained in closely controlled laboratory life testing groups of lamps at their design voltage. It is not necessarily the same as the service life where conditions such as shock, vibration, voltage fluctuation and environment may result in a shorter average attained life.

#### ELECTRIC SOCKET AND SUPPORT STAND ASSEMBLIES

Solar-Ray® Searchlights include a socket and support stand assembly based on the bulb or socket information given when ordering. The following chart makes it possible to order and stock different socket and stand assemblies for field conversion to meet a large variety of voltage and candlepower requirements with a minimum of inventory.

#### ORDERING INFORMATION

Socket Type (See Page 73 for Drawing)	Socket Code	For 10" Searchlights		For 12" Searchlights		For 14" Searchlights	
		Catalog Number	Height Stand Inches	Catalog Number	Height Stand Inches	Catalog Number	Height Stand Inches
Medium Screw	B	872 001	1-1/4	872 002	2-1/4	872 003	3-1/4
Medium Prefocus	E	873 001	1-5/16	873 002	1-15/16	873 003	2-15/16
Mogul Screw	D	-----	-----	874 002	7/16	874 003	1-1/4
2-Pin Prefocus (12 Volt)	F	875 001	3-1/2	875 002	4-1/2	875 003	5-1/2
2-Pin Prefocus (24 Volt)	G	876 001	3-1/4	876 002	4-1/4	876 003	5-1/4
2-Pin Prefocus (32 Volt)	H	878 001	3-1/4	878 002	4-1/4	878 003	5-1/4
2-Pin Prefocus (600 Watt)	I	879 001	3-1/8	879 002	4-1/8	879 003	5-1/8
2-Pin Prefocus (900 Watt)	K	-----	-----	880 002	3-13/16	880 003	4-13/16

**NOTE: Refer to Page 78 for Spare/Replacement Electric Socket Only Ordering Information.**



## BULB TECHNICAL DATA FOR SOLAR-RAY® SEARCHLIGHTS

### 800 SERIES

**THE FOLLOWING CHART IS PROVIDED TO AID IN PROPER BULB SELECTION:**

Searchlight Size Inches	Voltage	Approximate Range Miles*	Bulb Catalog Number	Bulb Wattage	Rated Life Hours**	Maximum Candlepower Output	Horizontal Beam Spread Degrees	Vertical Beam Spread Degrees
10"	12	1	816	100	50	1,168,000	1.7	1.4
	24	1	836	150	50	891,000	2.6	1.5
	32	3/4	817	200	200	571,000	2.6	1.7
	32	1	806	500	50	943,000	3.4	3.9
	120	1	820	600	75	908,000	4.4	2.2
	120	1-1/8	807	500	25	1,332,000	3.5	2.8
	120	1-1/8	844	500	500	1,260,000	3.1	3.4
12"	12	1-1/4	816	100	50	1,617,000	1.5	1.2
	24	1-1/8	836	150	50	1,349,000	2.2	1.5
	32	7/8	817	200	200	865,000	2.4	1.6
	32	1-1/8	806	500	50	1,496,000	3.4	3.5
	120	1	837	750	200	977,000	4.1	3.7
	120	1	845	750	200	1,185,000	3.7	5.2
	120	1-1/8	820	600	75	1,410,000	4.3	1.9
	120	1-1/4	809	750	25	1,792,000	3.6	3.4
	120	1-1/4	844	500	500	1,641,000	3.2	3.4
	120	1-1/4	807	500	25	1,799,000	3.3	3.1
	120	1-1/4	811	1000	50	1,816,000	4.0	4.9
	120	1-3/8	810	1000	25	1,894,000	4.0	3.8
	120	1-3/8	846	1000	200	1,911,000	3.9	5.0
	120	1-1/2	839	900	75	2,482,000	4.5	5.5
	230	7/8	860	1000	950	865,000	6.9	5.9
14"	12	1-1/4	816	100	50	1,756,000	1.5	1.0
	24	1-1/8	836	150	50	1,367,000	2.3	1.2
	32	1	817	200	200	943,000	2.2	1.5
	32	1-1/8	806	500	50	1,591,000	4.0	3.7
	120	1-1/8	837	750	200	1,254,000	3.9	4.5
	120	1-1/8	845	750	200	1,531,000	3.6	5.1
	120	1-1/4	820	600	75	1,626,000	4.5	1.9
	120	1-3/8	844	500	500	1,840,000	2.9	3.2
	120	1-3/8	811	1000	50	2,249,000	4.0	5.1
	120	1-1/2	807	500	25	2,353,000	3.2	3.2
	120	1-1/2	809	750	25	2,422,000	3.7	4.0
	120	1-1/2	846	1000	200	2,586,000	3.8	5.0
	120	1-1/2	810	1000	25	2,621,000	4.0	4.5
	120	1-5/8	839	900	75	2,889,000	4.5	5.2
	230	1	860	1000	950	1,021,000	7.7	6.2

\*The approximate ranges listed above are based on photometric measurements of beam candlepower output under ideal conditions. Many factors such as atmospheric conditions, size and color of target, background, etc., may reduce effective range considerably; therefore, these figures are offered only as a guide to compare different bulb and voltage options.

**\*\*NOTE:** These are the "Rated Average Laboratory Life in Hours" of the Bulb Manufacturer obtained in closely controlled laboratory life testing of groups of lamps at their design voltage. It is not necessarily the same as the service life where conditions such as shock, vibration, voltage fluctuation and environment may result in a shorter average attained life.



**2-PIN PREFOCUS**



**MOGUL SCREW**



**MEDIUM PREFOCUS**



**MEDIUM SCREW**

### 800 SERIES

- 1) **Head Assembly Type:** \_\_\_\_\_ }
  - a) For deck control - 883
  - b) For lever control - 884
  - c) For wheel and lever/gear control - 885
- 2) **Pedestal (overall) Height (see catalog page for details):** \_\_\_\_\_ }
  - a) Standard - O
  - b) Medium - M
  - c) High - H

*For custom pedestal height see no. 10 below.*
- 3) **Reflector Size:** \_\_\_\_\_ }
  - a) 10 inch - 1
  - b) 12 inch - 2
  - c) 14 inch - 3
- 4) **Finish:** \_\_\_\_\_ }
  - a) PERKOPLATE (polished chrome) - CHR
  - b) PERKO•KOTE (white) - WHT
- 5) **Control Type:** \_\_\_\_\_ }
  - a) Lever control (For 884 Head Assembly) - 851
  - b) Wheel control (For 885 Head Assembly) - 852
  - c) Lever/Gear control (For 885 Head Assembly) - 969
- 6) **Control Length (when necessary):** \_\_\_\_\_ }
  - a) (8-1/2" for 851 & 969) or (7-1/2" for 852) - 0
  - b) (15-1/2" for 851 & 969) or (14-1/2" for 852) - A
  - c) (22-1/2" for 851 & 969) or (21-1/2" for 852) - B
  - d) (29-1/2" for 851 & 969) or (28-1/2" for 852) - C
- 7) **Bulb Number (see pages 72 & 73 for details):** \_\_\_\_\_ }
 

**Bulb Cat. No.**
- 8) **Socket Type: .....Code: \_\_\_\_\_** }
  - a) Medium Screw ..... "B"
  - b) Medium Prefocus..... "E"
  - c) Mogul Screw..... "D" (Not for use with 10 inch reflector.)
  - d) 2-Pin Prefocus (12 volt) ..... "F"
  - e) 2-Pin Prefocus (24 volt) ..... "G"
  - f) 2-Pin Prefocus (32 volt) ..... "H"
  - g) 2-Pin Prefocus (600 Watt) ..... "I"
  - h) 2-Pin Prefocus (900 watt) ..... "K" (Not for use with 10 inch reflector.)

**Socket Code**
- 9) **Custom control length:** \_\_\_\_\_  
Specify control length desired as measured from pedestal base to lower end of control assembly ("E" or "F" dimension).
- 10) **Custom pedestal height:** \_\_\_\_\_  
Specify overall height of searchlight desired as measured from the top of the searchlight head to the bottom of the pedestal base ("J" dimension).

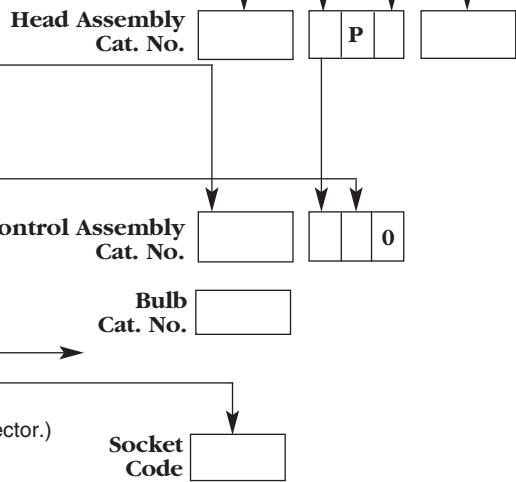

Searchlights

### SPARE PARTS FOR 800 SERIES SOLAR-RAY® SEARCHLIGHTS

Fig.	Size	Front Glass Cat. No.	Front Door with Glass Cat. No.	Rear Cover Cat. No.	Reflector* Cat. No.	Pinion Gear Cat. No.
883	10"	889 001 CLR	891 001 CHR	908 001 CHR	890 001	----
	12"	889 002 CLR	891 002 CHR	908 002 CHR	890 002	----
	14"	889 003 CLR	891 003 CHR	908 003 CHR	890 003	----
884	10"	889 001 CLR	891 001 CHR	902 001 CHR	890 001	----
	12"	889 002 CLR	891 002 CHR	902 002 CHR	890 002	----
	14"	889 003 CLR	891 003 CHR	902 003 CHR	890 003	----
885	10"	889 001 CLR	891 001 CHR	902 001 CHR	890 001	905
	12"	889 002 CLR	891 002 CHR	902 002 CHR	890 002	905
	14"	889 003 CLR	891 003 CHR	902 003 CHR	890 003	905

**NOTE: The Spare Part catalog numbers listed above are for the polished chrome (CHR) finish.**

**To order white finish, replace the "CHR" in the catalog number with the "WHT" finish code.**

\*Replacement Retaining Clips (Cat. No. 910) For The Reflector Should Also Be Ordered When Ordering a Replacement Reflector To Assure a Proper Fit.

## 19 INCH SOLAR-RAY® SEARCHLIGHT

### 1900 SERIES

**ALL ALUMINUM - WHITE PERKO•KOTE FINISH**  
**32, 120 OR 230 VOLTS**

The 1900 Series - Solar-Ray® Searchlights are designed and built with the commercial user in mind where maximum size and brilliance counts. These units are constructed of marine aluminum with heavy duty castings and heavy gauge reinforced bodies for extra durability. They are finished in our white PERKO•KOTE finish; an advanced process that eliminates the need for painting while providing a scratch resistant and chip-proof surface for painting when necessary to match the color of the vessel.

The 1900 Series is available with Deck, Wheel, Lever/Gear or Distant Electric Remote Controls. All models feature halo deflectors, parabolic glass mirror reflectors for maximum light output and ventilation covers for quick dissipation of heat to help prolong bulb life. Hinged front doors have quick release stainless steel latches to provide easy access for bulb replacement.

**Bulbs are not included and must be ordered separately.** PERKO offers a choice of the traditional incandescent or the brighter, more piercing quartz-halogen bulbs in a variety of voltages and wattages. For complete information on bulbs and candlepower output, see page 77.

### “1900 Series” High Power Searchlights Features

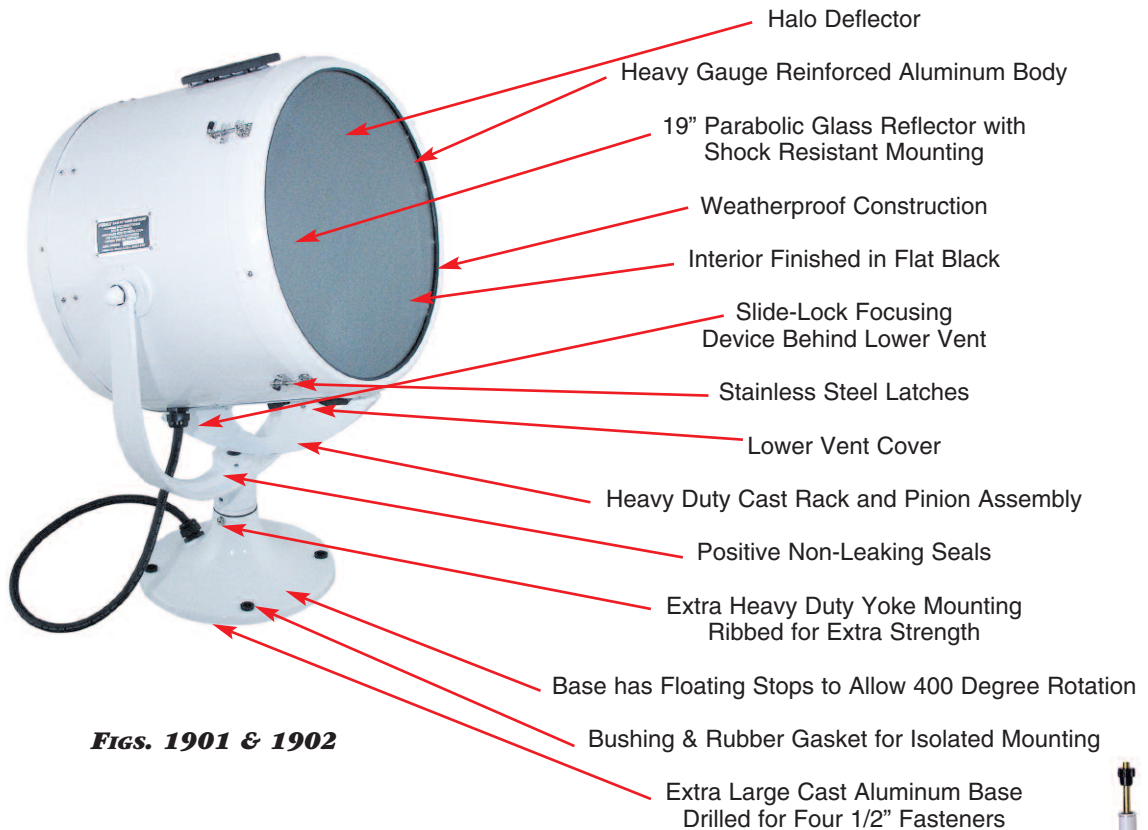

**Figs. 1901 & 1902**



**Fig. 1922**

**DECK CONTROL**  
 Equipped with handles on the rear cover for positioning.

**WHEEL CONTROL**  
 Turn upper wheel for horizontal position. Turn Lower Wheel for vertical position.

### CONTROL TYPES

#### DISTANT ELECTRIC CONTROL

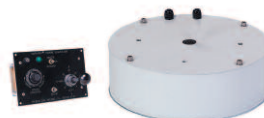

**Fig. 1925**

**LEVER/GEAR CONTROL**  
 Aim handle for horizontal position. Twist handle for vertical position.



**Fig. 1921**

### SEARCHLIGHT DIMENSIONS

Nominal Drum Diameter Inches	Nominal Drum Weight Pounds	Nominal Control Weight Pounds
19	68	22

Searchlights



**FIG. 1902 LIGHT SHOWN WITH FIG. 1921 LEVER/GEAR CONTROL**



**NEW**  
IMPROVED WATER-PROOF SEAL FOR GEAR MECHANISM



**FIG. 1902 DE4 LIGHT SHOWN WITH FIG. 1925 DISTANT ELECTRIC CONTROL**



**FIG. 1902 LIGHT SHOWN WITH FIG. 1922 WHEEL CONTROL**

Distance Between Wheels, 2-1/2 Inches.



**FIG. 1901 DECK CONTROL**

Base Diameter, 13 Inches.

**BULBS ARE NOT INCLUDED IN LIGHTS (SEE PAGE 77)**

## 19 INCH SOLAR-RAY® SEARCHLIGHT HEAD AND CONTROL ASSEMBLIES

**ALL ALUMINUM - WHITE PERKO•KOTE FINISH**

ORDERING INFORMATION	
Description	Catalog No.
Deck Control Searchlight Head Assembly*	1901 004 WHT
Wheel or Lever/Gear Control Searchlight Head Assembly (Requires Control Assembly Below)	1902 004 WHT
Searchlight Head Assembly For Distant Electric Control Base	1902 DE4 WHT
Wheel Control Assembly (For Above)	1922 000 WHT
Lever/Gear Control Assembly (For Above)	1921 000 WHT
Distant Electric Control Assembly (For Above)	1925 000 WHT

\*Cannot Be Fitted With Controls.

Custom Control Lengths and Pedestal Heights Are Available. Price Upon Application. Specify Measurements.

**BULBS ARE NOT INCLUDED IN LIGHTS (SEE BELOW)**

### BULB ORDERING INFORMATION FOR 19 INCH SEARCHLIGHTS

To give good results, the bulb and reflector must be perfectly compatible; therefore be sure to specify the catalog number of the bulb desired. Peak candlepower is exceedingly sensitive to many factors, (i.e., a light source out or focus by 1/32 inch, under-voltage of only 4%, or differences between bulb manufacturers can cause a reduction of range of up to 20%).

For a More Concentrated Beam, Longer Range, Brighter Light and a Longer Life, We Recommend the Quartz/Halogen Bulbs.

Voltage	Approx. Range Miles*	Bulb Catalog Number	Bulb Type	Socket Type	Socket Code Letter	Wattage	Rated Life Hours**	Maximum Candlepower Output	Horizontal Beam Spread Degrees	Vertical Beam Spread Degrees	Mfg. Bulb Code
32	1-2/3	806	Incandescent	Medium Screw	B	500	50	3,520,000	3.5	3.7	DLT
120	1-3/8	837	Incandescent	Medium Prefocus	E	750	200	2,076,000	3.6	4.2	DDY
120	1-5/8	845	Quartz/Halogen	Medium Prefocus	E	750	200	2,871,000	3.6	5.4	BTP
120	1-5/8	807	Incandescent	Medium Prefocus	E	500	25	3,191,000	3.5	4.0	CZX
120	1-2/3	859	Quartz/Halogen	Mogul Prefocus	M	2000	250	3,633,000	9.4	5.9	BVW
120	1-2/3	847	Quartz/Halogen	Mogul Prefocus	M	1000	200	3,659,000	4.5	5.4	BVV
120	1-3/4	844	Quartz/Halogen	Medium Prefocus	E	500	500	3,861,000	3.0	5.4	BTL
120	1-3/4	809	Incandescent	Medium Prefocus	E	750	25	4,569,000	3.6	4.5	DDB
120	1-7/8	846	Quartz/Halogen	Medium Prefocus	E	1000	200	4,601,000	4.5	5.4	BTR
120	2	848	Quartz/Halogen	Mogul Prefocus	L	1500	300	5,596,000	5.9	5.7	DTA
120	2	810	Incandescent	Medium Prefocus	E	1000	25	5,622,000	3.6	4.2	DRS
120	2	839	Quartz/Halogen	2-Pin Prefocus	K	900	75	5,769,000	5.9	5.4	BVA
230	1-3/8	860	Quartz/Halogen	Medium Prefocus	E	1000	950	2,162,000	7.9	6.5	FKD

\*The approximate ranges listed above are based on photometric measurements of beam candlepower output under ideal conditions. Many factors such as atmospheric conditions, size and color of target, background, etc., may reduce effective range considerably; therefore, these figures are offered only as a guide to compare different bulb and voltage options.

**PLEASE ORDER CAREFULLY, BULBS ARE NOT RETURNABLE.**

\*\*NOTE: These are the "Rated Average Laboratory Life in Hours" of the Bulb Manufacturer obtained in closely controlled laboratory life testing of groups of lamps at their design voltage. It is not necessarily the same as the service life where conditions such as shock, vibration, voltage fluctuation and environment may result in a shorter average attained life.

### ELECTRIC SOCKET AND SUPPORT STAND ASSEMBLIES FOR 19 INCH SEARCHLIGHTS

Solar-Ray® Searchlights include a socket and support stand based on the bulb or socket information given when ordering. The following chart makes it possible to order and stock different assemblies for field conversion, to meet a large variety of voltage and candlepower requirements with a minimum of inventory.

ORDERING INFORMATION			
Socket Type	Socket Code	Socket & Stand Catalog Number	Height Stand Inches
Medium Screw	B	872 004	5-3/4
Medium Prefocus	E	873 004	5-7/16
Mogul Prefocus (1500 Watt)	L	1930 004	3-5/8
Mogul Prefocus (1000 & 2000 Watt)	M	1931 004	3-1/8
2-Pin Prefocus (900 Watt)	K	880 004	7-5/16

### ORDERING INFORMATION

Fig. No.	Front Glass Cat. No.	Front Door with Glass Cat. No.	Rear Cover Cat. No.	Reflector* Cat. No.	Pinion Gear Cat. No.
1901	889 004 CLR	1936 000 WHT	1932 000 WHT	890 004	----
1902	889 004 CLR	1936 000 WHT	1933 000 WHT	890 004	905

\*Replacement Retaining Clips (Cat. No. 911) for the Reflector Should Also Be Ordered When Ordering a Replacement Reflector to Assure a Proper Fit.

### SPARE SOCKETS FOR 800 SERIES AND 1900 SERIES SOLAR-RAY® SEARCHLIGHTS

#### ORDERING INFORMATION



Medium Screw Socket  
(Code "B")  
Catalog No. 894.



Medium Prefocus Socket  
(Code "E")  
Catalog No. 895.

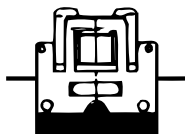

2-Pin Prefocus Socket  
(Codes "F, G, H & I\*\*")  
Catalog No. 899.

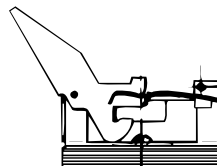

2-Pin Prefocus Socket  
(Code "K\*\*\*")  
Catalog No. 866.



Mogul Screw Socket  
(Code "D")  
Catalog No. 897.

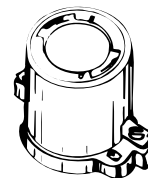

Mogul Prefocus Socket  
(Codes "L & M")  
Catalog No. 893.

\*For Use In 10", 12" and 14" Searchlights Except When Catalog No. 839, 900 Watt Bulb is Used.

\*\*For Use In 12", 14" and 19" Searchlights Only When the Catalog No. 839, 900 Watt Bulb is Used.

## XR SERIES XENON SEARCHLIGHTS

**15 INCH HOUSINGS - 500 WATT, 110 OR 220 VAC POWER SUPPLY**  
**19 INCH HOUSINGS - 1600 WATT, 220 OR 440 VAC POWER SUPPLY**

XR Series Xenon Searchlights are designed and manufactured to meet the demanding needs of commercial marine applications. The short arc Xenon filled lamps produce an extremely bright and very white light which can be focused in the pilothouse into a narrow long range beam. The heavy duty head of the 1,600 watt light is a marine grade aluminum casting with integral cooling fins to assure cool operation at high output levels. The cast marine aluminum yoke & base are equally rugged. High quality Timkin bearings provide for smooth 380° rotation.

The XR Series model 9854 is available manually controlled with a traditional lever gear control system or remotely controlled with a distant electric control system. In addition, an optional heating capability is available to assure trouble free operation in areas of the world prone to icing conditions. The XR Series model 9854 searchlight can be operated continuously at 1,600 watts for maximum brightness providing in excess of 100,000,000 candlepower and up to 5.5 mile (IES Handbook) range. The XR Series model 9304 searchlight can be operated continuously at 500 watts for a maximum brightness of 35,000,000 candlepower and over 3 1/2 mile (IES Handbook) range. An iridium coated precision reflector provides for maximum light output and sharp focus. The remote control panel controls lamp ignition (start-up) and focus from the pilot house. Superior cooling is provided by a heavy duty cooling fan which blows air across the lamp inside the sealed housing.

Both XR Series Searchlights include a single Xenon lamp. Perko offers a choice of several replacement lamps (800, 1,000 & 1,600 watt) which will operate in the 9854 series searchlight when the proper amperage settings have been chosen. For the 9304 series, a 500 watt Xenon lamp is the only available option.

Searchlights

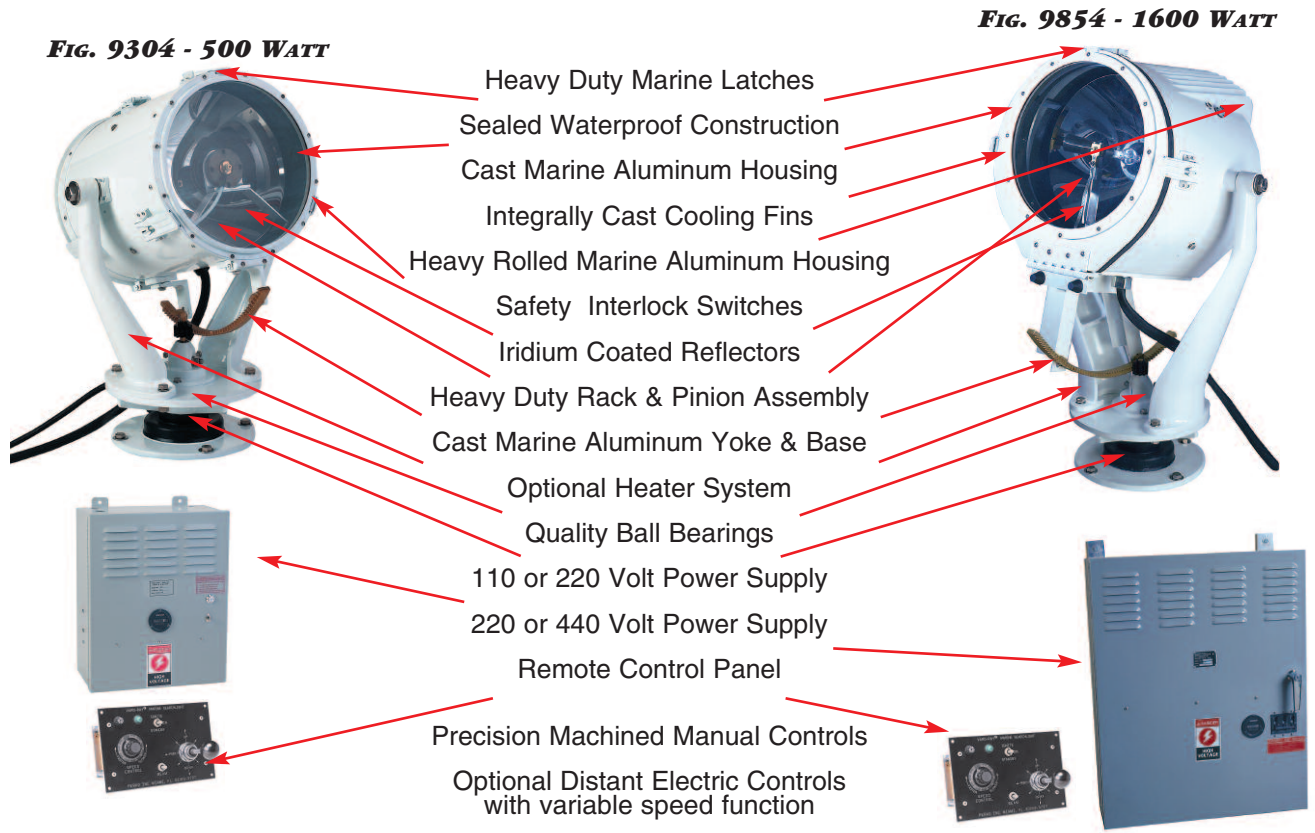

### FIG. 9304 & 9854 CONTROL TYPES

#### Lever Gear

Aim handle for horizontal position. Twist handle for vertical position.



#### REMOTE ELECTRIC

Joystick type controller with variable speed function for both horizontal & vertical positioning



## XR SERIES 15" XENON SEARCHLIGHTS

(500 WATT) WITH 120 OR 220 VAC POWER SUPPLY

### SEARCHLIGHT DIMENSIONS

Nominal Drum Diameter  
Inches  
13-3/4

Nominal Searchlight Assembly Weight  
Pounds  
71

17-3/4"  
Front to Back

13-3/4"

**FIG. 9304 LIGHT SHOWN WITH LEVER/GEAR CONTROL**

**FIG. 9304 LIGHT SHOWN WITH REMOTE DISTANT ELECTRIC CONTROL BASE**



**9510-010 CONTROL PANEL**



6"  
18"



28-1/4"

**FIG. 9304 HEAD, YOKE AND BASE ASSEMBLY**



**FIG. 9511 500 WATT POWER SUPPLY**

69-1/2"

**Gross Shipping Weight Including Crate**

	Pounds
Searchlight	130 Lbs
Power Supply	100 Lbs
Control Rod & Tube	19 Lbs

Base Diameter, 12 Inches.

### Complete 9304 XR SERIES Searchlights

#### ORDERING INFORMATION With Distant Electric Control Base

Lamp Type & Lamp Size	Voltage	Catalog No. Without Heaters	Catalog No. With Heaters
500 Watt Xenon	120 VAC	9304-E01-WH5	9304-EH1-WH5
500 Watt Xenon	220 VAC	9304-E02-WH5*	9304-EH2-WH5*

#### ORDERING INFORMATION With Lever/Gear Controls

Lamp Type & Lamp Size	Voltage	Catalog No. Without Heaters	Catalog No. With Heaters
500 Watt Xenon	120 VAC	9304-L01-WH5	9304-LH1-WH5
500 Watt Xenon	220 VAC	9304-L02-WH5*	9304-LH2-WH5*

**NOTE: Lamps are included with complete Searchlights.**

\* 500 Watt 220 Power Supply Ships 60hz unless 50hz is requested.



## XR SERIES 19" XENON SEARCHLIGHTS

(1600 WATT) WITH 220 & 440 (3Ø) VAC POWER SUPPLY

### SEARCHLIGHT DIMENSIONS

**Fig. 9854 LIGHT SHOWN WITH LEVER/GEAR CONTROL**  
 19-1/2" Front to Back  
 19" Height  
 Nominal Drum Diameter Inches: 19  
 Nominal Searchlight Assembly Weight Pounds: 145

**Fig. 9854 LIGHT SHOWN WITH REMOTE DISTANT ELECTRIC CONTROL BASE**  
 18" Width  
 6" Height  
**9551-007 REMOTE CONTROL PANEL**

**Fig. 9854 HEAD, YOKE AND BASE ASSEMBLY**  
 69-1/2" Height

**Fig. 9521-000 OPTICAL ASSY**

**Fig. 9512 POWER SUPPLY**  
 38" Height

**Gross Shipping Weight**  
 Searchlight: 266 Lbs  
 Power Supply: 246 Lbs  
 Control Rod & Tube: 16 Lbs

Searchlights

Base Diameter, 12 Inches.

### Complete 9854 XR SERIES Searchlights

ORDERING INFORMATION With Distant Electric Control Base				ORDERING INFORMATION With Manual Lever Control			
Lamp Type & Lamp Size	Voltage	Catalog No. Without Heaters	Catalog No. With Heaters	Lamp Type & Lamp Size	Voltage	Catalog No. Without Heaters	Catalog No. With Heaters
800 Watt Xenon	220 VAC	9854-E02-WH8	9854-EH2-WH8	800 Watt Xenon	220 VAC	9854-L02-WH8	9854-LH2-WH8
1000 Watt Xenon	220 VAC	9854-E02-WH0	9854-EH2-WH0	1000 Watt Xenon	220 VAC	9854-L02-WH0	9854-LH2-WH0
1600 Watt Xenon	220 VAC	9854-E02-WH6	9854-EH2-WH6	1600 Watt Xenon	220 VAC	9854-L02-WH6	9854-LH2-WH6
800 Watt Xenon	440 VAC	9854-E04-WH8	9854-EH4-WH8	800 Watt Xenon	440 VAC	9854-L04-WH8	9854-LH4-WH8
1000 Watt Xenon	440 VAC	9854-E04-WH0	9854-EH4-WH0	1000 Watt Xenon	440 VAC	9854-L04-WH0	9854-LH4-WH0
1600 Watt Xenon	440 VAC	9854-E04-WH6	9854-EH4-WH6	1600 Watt Xenon	440 VAC	9854-L04-WH6	9854-LH4-WH6

NOTE: Lamps are included with complete Searchlights.

## XR SERIES XENON SEARCHLIGHTS SPARE COMPONENTS

### MAJOR COMPONENT ORDERING INFORMATION



Searchlights

#### SEARCHLIGHT HEAD AND OPTICAL COMPONENTS

Cat. Number	Description
9504-000	Complete 15" Searchlight Head with Optical Assembly
9508-000	15" Searchlight Yoke & Base Assy Only
9501-000	Complete 19" Searchlight Head with Optical Assembly
9506-000	19" Searchlight Yoke & Base Assy Only
9521-000	Removable 1,600 Watt Optical Assembly.

#### POWER SUPPLY COMPONENTS

Cat. Number	Description
9511-000-110	500 Watt-110 Volt Power Supply
9511-000-220	500 Watt-220 Volt Power Supply
9510-000-220	1,000 Watt-220 Volt (3Ø) Power Supply
9510-000-440	1,000 Watt-440 Volt (3Ø) Power Supply
9512-000	1,600 Watt-220 Volt (3Ø) Power Supply
9514-000	1,600 Watt-440 Volt (3Ø) Power Supply

#### METERS, GAUGES & CONTROL COMPONENTS

Cat. Number	Description
9530-000	Std. Length Lever Gear Mechanical Controls for Fig. 9854
9551-000	Remote Distant Electric Controls for Fig. 9854
9551-001	Additional Slave Controller for Distant Electric Control
9510-009	Remote Ammeter
9510-003	Hour Meter
9510-010	Control Panel Assembly
9551-007	Distant Electric Base Control Panel
9551-001	Slave Controller

#### ADDITIONAL COMPONENTS

Cat. Number	Description
9510-001	Accessory Transformer
9510-013	Main Power Transformer
9521-009	Excitation Transformer
9521-017	Injection Transformer
9510-011	Power Supply Fan
9521-008	Optical Assembly Fan
9521-003	Spark Gap Assembly
9510-005	Ignite Toggle Switch
9510-006	Beam Focus Switch

#### SEARCHLIGHT TOOLS

Cat. Number	Description
9582-001	9/64" Hex (Lamp Changing) Tool
9582-002	500 Watt and 1KW Lamp Extractor Tool
9582-003	1/4" x 10" Reflector Adjusting Wrench
9582-005	Spare Emulator Kit for Fig. 9854 (See Manual Fig. 9581-001 for item list)

#### MANUALS

Cat. Number	Description
9581-001	Installation Manual - For Fig. 9854 Complete Searchlights
9581-002	Installation Manual - For Fig. 9551 Remote Distant Electric Control Unit
9581-003	Installation Manual - For Figs. 9501 & 9521 Head and Optical Assemblies
9581-004	Installation Manual - For Fig. 9304 Complete Searchlights



### XR SERIES Xenon Lamps

#### ORDERING INFORMATION

#### AMPERAGE RATINGS

**WARNING!!**  
Xenon lamps are filled with Xenon Gas under high pressure. They may explode in either hot or cold state, especially if dropped or mishandled. **ALWAYS wear protective safety equipment** (a protective face mask with neck guard, chest protector, heavy clothing and leather gloves) **when handling a lamp.**

Xenon Lamp Size	Catalog Number	Current Range	Recommended Operation	Candle Power	Range Miles
300 Watt*	9563-000	12A - 16A	15A @ 20V	20,000,000	3.1
500 Watt*	9565-000	20A - 30A	30A @ 15V	35,000,000	3.8
800 Watt	9568-000	30A - 45A	37A @ 19V	65,000,000	4.5
1000 Watt	9560-000	30A - 55A	50A @ 20V	80,000,000	5.1
1600 Watt	9566-000	50A - 70A	65A @ 24V	100,000,000	5.5

**PERKO Purchase Notification**

Purchase Price \_\_\_\_\_

Date Completed \_\_\_\_\_

Date of Purchase \_\_\_\_\_

Authorized Dealer \_\_\_\_\_

Motor Vessel Name \_\_\_\_\_

PERKO Inc.  
Miami, FL. 33169

**PERKO Warranty Registration**

Purchase Price \_\_\_\_\_

Motor Reading \_\_\_\_\_

Date of Installation \_\_\_\_\_

Authorized Dealer \_\_\_\_\_

Motor Vessel Name \_\_\_\_\_

PERKO Inc.  
Miami, FL. 33169

\* 300W and 500W lamps shown as replacements on earlier VARO 300W and 500W model Searchlights only - Not used on 9854 Series Searchlights.

#### LAMP WARRANTIES REQUIRE COMPLETION OF WARRANTY REGISTRATION FORMS SHORTLY AFTER PURCHASE AND INSTALLATION

**NOTE: PERKO offers a limited warranty on both the shelf and operating life of the XR Series Xenon lamps. Please see the XR Series "Limited Eighteen (18) Month Warranty" for all explicit terms and conditions of this warranty. All XR Series Xenon lamps are supplied with an adapter sized to fit XR Series Searchlights. Adapters for other searchlights can be manufactured upon request. Contact customer service for details.**

## BULKHEAD LIGHTS

**FIG. 217 - BULKHEAD LIGHT FIXTURE**

**CONSTRUCTION:**

- \* **CHROME PLATED ZINC ALLOY**
- \* **MEDIUM SCREW SOCKET**
- \* **TURN SWITCH**
- \* **BULB NOT INCLUDED**

**FOR SYSTEMS UP TO 50 VOLTS**



**FIG. 217**



**ORDERING INFORMATION**

Dimensions Base Inches	Projection Less Lamp Inches	Dealer Pkg. - 5 Cards 1 Pc. per Card	Screw Size	Ship Wt. Carton Lbs. Dealer Pkg.
2-1/2 x 1-3/4	2-5/8	217 DP CHR	6 R.H.	3.0

Spare Bulb Socket Assembly with Switch and Knob, Cat. No. 223.  
Refer to Page 97 for Bulb Selection.

**FIG. 1303 - BULKHEAD LIGHT FIXTURES**

**CONSTRUCTION OPTIONS:**

- \* **BLACK MOLDED PLASTIC**
- \* **WHITE MOLDED PLASTIC**
- \* **BULB NOT INCLUDED**

**FOR SYSTEMS UP TO 50 VOLTS**

**SIZE No. 1 HAS DOUBLE CONTACT BAYONET SOCKET  
WILL ACCOMMODATE A BULB UP TO 24 WATTS**

**SIZE No. 2 HAS MEDIUM SCREW SOCKET  
WILL ACCOMMODATE A BULB UP TO 40 WATTS**



**FIG. 1303 BLACK**



**FIG. 1303 WHITE**



**ORDERING INFORMATION**

Dimensions Wall Plate Inches	Normal Projection Inches	Length Shade Inches	Black Std. Pkg. - 1 Pc. OEM Pkg. - 50 Pcs.	White Std. Pkg. - 1 Pc. OEM Pkg. - 50 Pcs.	Screw Size	Ship Wt. Carton Lbs. Std. Pkg/OEM Bulk
4-1/2 x 3-1/4	4-3/8	3	1303 001 BLK	1303 001 WHT	8	0.4/15.0
4-1/2 x 3-1/4	5	4-1/2	1303 002 BLK	1303 002 WHT	8	0.5/18.7

Spare Switch, Cat. No. 701 DP.  
Refer to Page 97 for Bulb Selection.

Lighting Fixtures, Bulbs and Battery Switches

## UTILITY LIGHTS

**FIG. 1156 - L.E.D. CEILING MOUNT UTILITY LIGHT**



**Fig. 1156**



**L.E.D.'s**

**CONSTRUCTION OPTIONS:**

- \* CHROME PLATED BRASS & WHITE PLASTIC OR WHITE PERKO•KOTE BRASS
- \* 12 VOLT L.E.D.
- \* INSTALLS IN A 2-1/8" DIAMETER HOLE
- \* USES LESS THAN HALF THE ENERGY DRAW OF STANDARD LIGHTS



**ORDERING INFORMATION**

Finish	O.D. Overall Inches	Depth Inches	Dealer Pkg. 5 Cards 1 Pc. per Card	OEM Bulk Package 10 Pcs.	Screw Size	Ship Wt. Carton Lbs. DP/OEM Bulk Pkg.
Chrome	3	1	1156 DP1 12V	1156 001 12V	8	1.4/5.1
White	3	1	1156 DP1 WHT	1156 001 WHT	8	1.5/4.1



**L.E.D. CIRCUIT**

Lighting Fixtures, Bulbs and Battery Switches

**FIG. 1146 - "REDUCED GLARE" DESIGN COCKPIT LIGHT**



**Fig. 1146 CHROME**

**CONSTRUCTION OPTIONS:**

- \* CHROME PLATED BRASS WITH BLACK PLASTIC BASE
- \* WHITE PLASTIC WITH BLACK PLASTIC BASE
- \* 12, 24 OR 32 VOLT BULB INCLUDED.
- \* DESIGNED TO DIRECT 80% OF THE LIGHT DOWNWARD, THUS REDUCING COCKPIT GLARE.
- \* INSTALLS IN A 2-1/8" DIAMETER HOLE.



**ORDERING INFORMATION**

Finish	O.D. Overall Inches	Depth Inches	Voltage	Dealer Pkg. 5 Cards 1 Pc. per Card	OEM Bulk Package 25 Pcs.	Screw Size	Ship Wt. Carton Lbs. DP/OEM Bulk Pkg.
Chrome	3	1	12	1146 DP1 12V	1146 001 12V	8	1.4/5.1
Chrome	3	1	24	1146 DP2 24V	1146 002 24V	8	1.4/5.1
Chrome	3	1	32	1146 DP3 32V	1146 003 32V	8	1.4/5.1
White	3	1	12	1146 DP1 WHT	1146 001 WHT	8	1.5/4.1
White	3	1	24	1146 DP2 WHT	1146 002 WHT	8	1.5/4.1
White	3	1	32	1146 DP3 WHT	1146 003 WHT	8	1.5/4.1



**Fig. 1146 WHITE PLASTIC**

Spare 12 Volt Bulbs (2 Per Card), Cat. No. 70 DP0 CLR.  
 Spare 24 Volt Bulbs (2 Per Card), Cat. No. 67 DP1 CLR.  
 Spare 32 Volt Bulbs (2 Per Card), Cat. No. 70 DP2 CLR.

Spare Socket Assembly, Cat. No. 1146 000 99B.  
 Spare Lens with Gasket, Cat. No. 1146 DP 99A.  
 Spare Mounting Flange, Cat. No. 946 000 99C



**FIG. 137/140 - SURFACE MOUNT UTILITY LIGHT**  
**FIG. 145 - L.E.D. SURFACE MOUNT UTILITY LIGHT**



**Fig. 137**

**CONSTRUCTION OPTIONS:**

- Fig. 137 - MOLDED BLACK PLASTIC**
- \* SHIELDED LIGHT COVER
- Fig. 140/145 - MOLDED WHITE PLASTIC**
- \* DIFFUSED LIGHT COVER
- \* 12 VOLT, 1 WATT BULB INCLUDED OR L.E.D. VERSION

**NEW L.E.D. Version**



**ORDERING INFORMATION**

Dimensions Inches	Dealer Pkg. 10 Cards 1 Pc. per Card	OEM Bulk Pkg. 100 Pcs.	Screw Size	Ship Wt. Carton Lbs. DP/OEM Bulk Pkg.
1-7/8 x 9/16	137 DP BLK	137 000 BLK	6	0.5/2.2
1-7/8 x 9/16	140 DP NYN	140 000 NYN	6	0.4/1.9
1-7/8 x 9/16	145 DP NYN	145 000 NYN	6	0.4/1.9



**Figs. 140 & 145**



## UTILITY LIGHTS

**FIG. 1074 - FLUSH L.E.D. UTILITY LIGHTS WITH SNAP ON FRONT COVER**

**FIG. 1084 - FLUSH L.E.D. UTILITY LIGHT WITH 4 MOUNTING HOLES**

**CONSTRUCTION OPTIONS:**

- \* **BLACK OR WHITE MOLDED PLASTIC**
  - \* **DIFFUSION LENS**
  - \* **12 VOLT L.E.D.**
  - \* **USES LESS THAN HALF THE ENERGY DRAW OF STANDARD LIGHTS**
  - \* **INSTALLS IN A 1-3/4" DIAMETER HOLE**
  - \* **FIG. 1074 SNAP-ON FRONT COVER CONCEALS MOUNTING SCREWS**
- SUPPLIED WITH 7" WIRE LEADS**



**FIG. 1074 BLK**



**FIG. 1074 WHT**



**FIG. 1084 BLACK**



**FIG. 1084 WHITE**

L.E.D.'s



Pig Tail Leads (#2 Style)



**ORDERING INFORMATION**

Color	Dimensions Inches	Depth Inches	Dealer Pkg. 10 Cards 1 Pc. per Card	OEM Bulk Pkg. 100 Pcs.	Ship Wt. Carton Lbs. DP/OEM Bulk Pkg.
Black	2-1/4 x 2-1/4	15/16	1074 DP2 BLK	1074 002 BLK	1.2/7.0
White	2-1/4 x 2-1/4	15/16	1074 DP2 WHT	1074 002 WHT	1.2/7.0
Black	2-1/4 x 2-1/4	15/16	1084 DP2 BLK	1084 002 BLK	1.2/7.0
White	2-1/4 x 2-1/4	15/16	1084 DP2 WHT	1084 002 WHT	1.2/7.0

Screw Size, No. 6.

Lighting Fixtures, Bulbs and Battery Switches

**FIG. 1044 - FLUSH UTILITY LIGHT WITH SNAP ON FRONT COVER**  
**FIG. 1064 - FLUSH UTILITY LIGHT WITH 4 MOUNTING HOLES**

**CONSTRUCTION OPTIONS:**

- \* **BLACK OR WHITE MOLDED PLASTIC**
  - \* **DIFFUSION LENS**
  - \* **12 VOLT, 3 WATT BULB INCLUDED**
  - \* **INSTALLS IN A 1-3/4" DIAMETER HOLE**
  - \* **FIG. 1044 SNAP-ON FRONT COVER CONCEALS MOUNTING SCREWS**
- No. 1 SUPPLIED WITH 1/4" SPADE CONNECTORS**  
**No. 2 SUPPLIED WITH 7" WIRE LEADS**



**FIG. 1044 BLK**



**FIG. 1044 WHT**



**FIG. 1064 BLACK**



**FIG. 1064 WHITE**

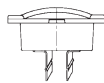

Spade Connectors (#1 Style)

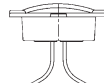

Pig Tail Leads (#2 Style)



**ORDERING INFORMATION**

Color	Dimensions Inches	Depth Inches	Dealer Pkg. 10 Cards 1 Pc. per Card	OEM Bulk Pkg. 100 Pcs.	Ship Wt. Carton Lbs. DP/OEM Bulk Pkg.
Black	2-1/4 x 2-1/4	15/16	1044 DP1 BLK	1044 001 BLK	1.1/6.0
Black	2-1/4 x 2-1/4	15/16	1044 DP2 BLK	1044 002 BLK	1.2/7.0
White	2-1/4 x 2-1/4	15/16	1044 DP1 WHT	1044 001 WHT	1.1/6.0
White	2-1/4 x 2-1/4	15/16	1044 DP2 WHT	1044 002 WHT	1.2/7.0
Black	2-1/4 x 2-1/4	15/16	1064 DP1 BLK	1064 001 BLK	1.1/6.0
Black	2-1/4 x 2-1/4	15/16	1064 DP2 BLK	1064 002 BLK	1.2/7.0
White	2-1/4 x 2-1/4	15/16	1064 DP1 WHT	1064 001 WHT	1.1/6.0
White	2-1/4 x 2-1/4	15/16	1064 DP2 WHT	1064 002 WHT	1.2/7.0

Screw Size, No. 6.

Spare Bulbs, Cat. No. 1044 DP 99A. (2 Per Card)

**FIG. 1254 - ADJUSTABLE UTILITY LIGHT**



**FIG. 1254**

**CONSTRUCTION:**

- \* CHROME PLATED ZINC ALLOY
- \* SHIELD SWIVELS TO CHANGE POSITION
- \* 12 VOLT, 7 WATT BULB INCLUDED



**ORDERING INFORMATION**

O.D. Overall Inches	Length Neck Inches	O.D. Neck Inches	Dealer Pkg. 5 Cards 1 Pc. per Card	Screw Size	Ship Wt. Carton Lbs. Dealer Pkg.
2-5/8	3/4	7/8	1254 DP CHR	6	2.8

Spare Bulbs (2 per card), Cat. No. 337 011 DP.  
Spare Socket, Cat. No. 24 DP1.

**FIG. 318 - SURFACE MOUNT LIGHT**



**FIG. 318**

**CONSTRUCTION:**

- \* WHITE TRANSLUCENT PLASTIC COVER
- \* WHITE PERKO-KOTE CAST ZINC ALLOY BASE WITH INTEGRAL JUNCTION BOX
- \* DUAL VOLTAGE, FOR 12 AND 120 VOLTS
- \* DOUBLE CONTACT BAYONET SOCKETS
- \* COMPLETE WITH TWO 12 VOLT, 11 WATT AND TWO 120 VOLT, 15 WATT BULBS



**ORDERING INFORMATION**

Length Inches	Width Inches	Depth Inches	Dealer Pkg 5 Cards 1 Pc. per Card	OEM Bulk Pkg. 10 Pcs.	Screw Size	Ship Wt. Carton Lbs. DP/OEM Bulk Pkg.
9-3/4	3-1/2	1-7/8	318 DP	318 A00	10	9.4/18.5

Spare 12 Volt Bulbs (2 per card), Cat. No. 337 012 DP. Spare Socket, Cat. No. 24 DP1.  
Spare 120 Volt Bulbs (2 per card), Cat. No. 337 023 DP. Spare Globe, Cat. No. 318 A00 99D.  
Spare Switches with Square Buttons (1 Each High and Low), Cat. No. 318 A00 99E.

**FIGS. 1087 & 1090 - VAPOR PROOF LIGHT FIXTURES**



**FIG. 1090**

**FIG. 1087**



- CONSTRUCTION:**
- \* SATIN FINISH DIE CAST ALUMINUM WITH GLASS GLOBES
  - \* INTEGRAL JUNCTION BOX WITH FOUR 1/2 INCH I.P.S. FITTINGS
  - \* MEDIUM SCREW SOCKET FOR BULBS UP TO 100 WATTS
  - \* BULB NOT INCLUDED

**FIG. 1087, CEILING MOUNT**  
**FIG. 1090, BULKHEAD MOUNT**

**ORDERING INFORMATION**

O.D. Box Inches	Length Overall Inches	Projection Inches	Standard Pkg. - 1 Pc.	Bolt Size	Ship Wt. Carton Lbs. Standard Pkg.
3-3/4	9-1/2	---	1087 000 ALU	1/4	2.9
3-3/4	10	7	1090 000 ALU	1/4	3.4

Note: These Fixtures are listed in accordance with U.L. Standard 1598, "UL Standard for Safety for Luminaries".  
**Not** evaluated for use in hazardous or explosive atmospheres.

Spare Guards, Cat. Nos. 1087 000 99A and 1090 000 99A. Spare Sockets, Cat. Nos. 1087 000 99B and 1090 000 99B.  
Spare Globes, Cat. Nos. 1087 000 99C and 1090 000 99C. Refer to Page 97 for Bulb Selection.

## SPREADER LIGHTS

**FIG. 1040 - ADJUSTABLE SPREADER LIGHT**

**CONSTRUCTION:**

- \* **MOLDED BLACK PLASTIC BODY**
- \* **CHROME PLATED BRASS MOUNTING BRACKET**
- \* **SCREW IN LENS RETAINING RING FOR EASE OF RE-BULBING**
- \* **12, 24 OR 32 VOLT SEALED BEAM UNIT INCLUDED**



**FIG. 1040**



**ORDERING INFORMATION**

Voltage	O.D. Inches	Depth Inches	Dimensions		Cards Per Pkg.	OEM Bulk Pkg. 10 Pcs.	Ship Wt. Carton Lbs. DP/OEM Bulk Pkg.
			Bracket Inches	Dealer Pkg. 1 Pc. per Card			
12	4-1/2	4-1/2	4-1/2 x 1	1040 DP1 12V	5	1040 001 12V	8.2/13.5
24	4-1/2	4-1/2	4-1/2 x 1	1040 DP2 24V	2	1040 002 24V	3.4/13.5
32	4-1/2	4-1/2	4-1/2 x 1	1040 DP3 32V	2	1040 003 32V	3.4/13.5

Screw Size, No. 12 R.H.  
 Spare Sealed Beam Unit (12 Volt), Cat. No. 432 001 12V.  
 Spare Sealed Beam Unit (24 Volt), Cat. No. 432 002 24V.  
 Spare Sealed Beam Unit (32 Volt), Cat. No. 432 003 32V.

**FIG. 280 - ADJUSTABLE SPREADER LIGHT**

**CONSTRUCTION:**

- \* **CHROME PLATED BRASS**
- \* **12, 24 OR 32 VOLT SEALED BEAM UNIT INCLUDED**



**FIG. 280**



**ORDERING INFORMATION**

Voltage	O.D. Inches	Depth Inches	Dimensions		Cards per Pkg.	OEM Bulk Pkg. 10 Pcs.	Ship Wt. Carton Lbs. DP/OEM Bulk Pkg.
			Bracket Inches	Dealer Pkg. 1 Pc. per Card			
12	4-5/8	2-1/2	5-3/8 x 3/4	280 DP1 12V	5	280 001 12V	6.5/10.1
24	4-5/8	2-1/2	5-3/8 x 3/4	280 DP2 24V	2	280 002 24V	2.7/10.1
32	4-5/8	2-1/2	5-3/8 x 3/4	280 DP3 32V	2	280 003 32V	2.7/10.1

Screw Size, No. 12 R.H.  
 Spare Sealed Beam Unit (12 Volt), Cat. No. 432 001 12V.  
 Spare Sealed Beam Unit (24 Volt), Cat. No. 432 002 24V.  
 Spare Sealed Beam Unit (32 Volt), Cat. No. 432 003 32V.

**FIG. 265 - FIXED SPREADER LIGHT**

**CONSTRUCTION:**

- \* **CHROME PLATED BRONZE**
- \* **12 VOLT, 10 WATT BULB INCLUDED**



**FIG. 265**



**ORDERING INFORMATION**

O.D. Inches	Depth Inches	Dealer Pkg. 5 Pcs. 1 Pc. per Pkg.	OEM Bulk Pkg. 10 Pcs.	Screw Size	Ship Wt. Carton Lbs. DP/OEM Bulk Pkg.
2-3/4	1-3/8	265 DP CHR	265 000 CHR	6	2.0/3.3

Spare Bulbs (2 per card), Cat. No. 70 DP0 CLR.  
 Spare Socket Assembly, Cat. No. 265 000 99A.  
 Spare Lens with O-Ring, Cat. No. 284 DP CLR.

**FOR REPLACEMENT BULB INFORMATION REFER TO PAGE 97.**

Lighting Fixtures, Bulbs and Battery Switches

## DOME LIGHTS

**FIG. 300**

**FIG. 300 - SURFACE MOUNT DOME LIGHT**

**FIG. 1253 - EXTERIOR SURFACE MOUNT DOME LIGHT**

**FIG. 1263 - EXTERIOR SURFACE MOUNT DOME LIGHT WITH RED & WHITE BULBS**



**FIG. 1253**

**FIG. 1263**

**CONSTRUCTION:**

- FIG. 300 - CHROME PLATED ZINC ALLOY**
- FIG. 1253 - IVORY PERKO•KOTE ZINC ALLOY**
- FIG. 1263 - IVORY PERKO•KOTE ZINC ALLOY**

- \* DOUBLE CONTACT BAYONET SOCKET**
- \* BLACK VINYL MOUNTING GASKET**
- \* FIGS. 300 & 1253 - PUSH SWITCH WITH WATER RESISTANT BOOT**
- \* FIG. 1263 - THREE POSITION TOGGLE SWITCH**
- \* 12 VOLT BULBS INCLUDED**



**ORDERING INFORMATION**

O.D. Globe Inches	O.D. Base Inches	Depth Overall Inches	Wattage of Bulb Supplied	Maximum Wattage	Dealer Pkg. - 5 Cards 1 Pc. per Card	OEM Bulk Pkg. 10 Pcs.	Screw Size	Ship Wt. Carton Lbs. DP/OEM Bulk
3	3-3/4	1-1/2	7	11	300 DP0 CHR	300 000 CHR*	10 R.H.	3.1/10.5
4	5	1-7/8	11	17	300 DP1 CHR	300 001 CHR	10 R.H.	4.8/8.3
5	6	2	17	17	300 DP2 CHR	300 002 CHR	12 R.H.	6.7/11.4
4	5	1-7/8	11	17	1253 DP1 WHT	1253 001 WHT	10 R.H.	4.8/8.4
5	6	2	17	17	1253 DP2 WHT	1253 002 WHT	12 R.H.	6.6/11.6
4	5	1-7/8	11	17	1263 DP1 WHT	1263 001 WHT	10 R.H.	4.8/8.4

\*OEM Bulk Pkg., 20 Pcs.

Spare Bulbs (2 per card) for 3 Inch Light, Cat. No. 337 011 DP.  
 Spare Bulbs (2 per card) for 4 Inch Light, Cat. No. 337 012 DP.  
 Spare Bulbs (2 per card) for 5 Inch Light, Cat. No. 337 013 DP.  
 Spare Red Bulb (2 per card) for Fig 1263, Cat. No. 337 R12 DP.

Spare Switch for Figs 300 & 1253, Cat. No. 701 DP.  
 Spare Socket, Cat. No. 24 DP1.  
 Spare Globe, Cat. No. 257 DP, Specify Size.

**NOTE: To Use Figs 300 & 1253 IN A 24 VOLT SYSTEM, ORDER REPLACEMENT BULBS (1 PER CARD) CAT. No. 337 014 DP.**



**FIG. 1258**



**FIG. 1260**

**FIG. 1258 - ROUND SURFACE MOUNT DOME LIGHT**

**FIG. 1260 - SQUARE SURFACE MOUNT DOME LIGHT**

**CONSTRUCTION:**

- \* CHROME PLATED ZINC ALLOY**
- \* WHITE TRANSLUCENT PLASTIC GLOBE**
- PUSH SWITCH WITH WATER RESISTANT BOOT**
- \* 12 VOLT, 10 WATT BULB INCLUDED**

**ORDERING INFORMATION**

O.D. Base Inches	Depth Overall Inches	Maximum Wattage	Dealer Pkg. - 5 Cards 1 Pc. per Card	OEM Bulk Pkg. 10 Pcs.	Screw Size	Ship Wt. Carton Lbs. DP/OEM Bulk
3-3/4	1-1/4	10	1258 DP2 CHR	1258 002 CHR	8 R.H.	3.0/5.1
Dimensions Base Inches	Depth Overall Inches	Maximum Wattage	Dealer Pkg. - 5 Cards 1 Pc. per Card	OEM Bulk Pkg. 10 Pcs.	Screw Size	Ship Wt. Carton Lbs. DP/OEM Bulk
3-5/8 x 4-1/4	1-1/4	10	1260 DP2 CHR	1260 002 CHR	8 R.H.	3.6/6.2

Spare Bulbs (2 per card), Cat. No. 70 DP0 CLR.  
 Spare Globe Fig. No. 1258, Cat. No. 244 002 WHT.

Spare Switch, Cat. No. 701 DP.  
 Spare Globe Fig. No 1260, Cat. No. 245 002 WHT.

**NOTE: To Use THESE LIGHTS IN A 24 VOLT SYSTEM, ORDER REPLACEMENT BULBS (2 PER CARD) CAT. No. 67 DP1 CLR.**

Lighting Fixtures, Bulbs and Battery Switches



## DOME LIGHTS

**FIG. 555 - SURFACE MOUNT DOME LIGHT**

**CONSTRUCTION:**

- \* **CHROME PLATED BRONZE**
- \* **FOR SYSTEMS UP TO 50 VOLTS**
- \* **TWIN DOUBLE CONTACT BAYONET SOCKETS**
- \* **TOGGLE SWITCH. BULBS NOT INCLUDED**
- \* **WILL ACCOMMODATE BULBS UP TO 20 WATTS EACH**



**FIG. 555**

**ORDERING INFORMATION**

O.D. Globe Inches	O.D. Base Inches	Depth Inches	Standard Pkg. - 1 Pc.	Screw Size	Ship Wt. Carton Lbs. Standard Pkg.
6	7-7/8	3-1/8	555 000 CHR	8	4.2

Spare Switch, Cat. No. 514 DP.  
Spare Socket, Cat. No. 276 000.

Spare Globe, Cat. No. 257 DP6.  
Refer to Page 97 for Bulb Selection.

Lighting Fixtures, Bulbs and Battery Switches

**FIG. 753 - SURFACE MOUNT DOME LIGHT**

**CONSTRUCTION:**

- \* **CHROME PLATED WROUGHT BRASS**
- \* **MEDIUM SCREW SOCKET, TOGGLE SWITCHES**
- \* **BULBS NOT INCLUDED.**
- \* **FOR SYSTEMS UP TO 50 VOLTS.**
- \* **SIZE NO. 1 HAS ONE SOCKET AND SWITCH. WILL ACCOMMODATE ONE BULB UP TO 50 WATTS**
- \* **SIZE NO. 2 HAS TWO SOCKETS AND SWITCHES WILL ACCOMMODATE TWO BULBS UP TO 25 WATTS EACH**

**IMPROVED PRODUCT**



**FIG. 753**

**ORDERING INFORMATION**

O.D. Glass Inches	O.D. Base Inches	Depth Inches	Standard Pkg. - 1 Pc.	Screw Size	Ship Wt. Carton Lbs. Standard Pkg.
8	9-1/2	4	753 001 CHR	10 R.H.	2.9
8	9-1/2	4	753 002 CHR	10 R.H.	3.0

Spare Switch, Cat. No. 514 DP.  
Flat Spare Lens For Newer 753 Style (4" Depth), Cat. No. 132 FLT FRD.  
Curved Spare Lens For Older 753 Style (3" Depth), Cat. No. 132 CVD FRD.  
Spare Socket, Cat. No. 1323.  
Refer to Page 97 for Bulb Selection.

**ON JANUARY 31, 1977 THE U.S.C.G. PUBLISHED SAFETY STANDARDS FOR MARINE ELECTRICAL SYSTEMS. THESE STANDARDS COVER SUCH TECHNICAL DETAILS AS:**

- **BATTERIES AND ASSOCIATED CONDUCTORS**
- **CONDUCTOR SIZE AND AMPACITY**
- **STRAIN RELIEF AND PULL TESTS**
- **TERMINATION REQUIREMENTS**
- **OVERCURRENT PROTECTION**
- **IGNITION PROTECTION**
- **GROUNDING**
- **INSULATION**

A particular electrical component may be affected by some or all of the above categories. Those categories related to product design have been complied with, however, many additional details must be considered by the installer of the equipment as well in order to achieve compliance with this standard. It is suggested that the actual standard be familiarized when installing equipment. Perhaps one of the most critical requirements is ignition protection. A product that is marked "Ignition Protected" can be used in that area of a boat that is not isolated from a gasoline fuel vapor source. Refer to the actual standard for a determination of what parts of a boat require Ignition Protected products. If a product is not plainly marked "Ignition Protected" then assume it is not.

**FOR DETAILS ON ALL OF THE ABOVE, OBTAIN THE FOLLOWING:  
U.S.C.G. SAFETY STANDARDS FOR ELECTRICAL SYSTEMS  
CFR TITLE 33, CHAPTER 1, SUBCHAPTER S, PART 183, SUBPART I.**

## BATTERY SWITCHES

**BATTERY DISCONNECT SWITCHES HELP MANAGE THE OVERALL USE OF ELECTRICAL POWER ONBOARD. THEY ARE USED TO CONNECT OR DISCONNECT ELECTRICAL DEVICES FROM THE ELECTRICAL SYSTEM. THEY HELP TO PREVENT BATTERY DRAIN DURING PERIODS OF INACTIVITY. THEY ALLOW FOR A QUICK AND EASY WAY TO SHUT DOWN THE ENTIRE ELECTRICAL SYSTEM IN AN EMERGENCY. AN OPTIONAL KEY LOCK HELPS TO PREVENT UNAUTHORIZED USE OF THE VESSEL.**

**IN ADDITION TO DOING EVERYTHING A BATTERY DISCONNECT SWITCH DOES, BATTERY SELECTOR SWITCHES PERMIT BATTERY SELECTION (OF TWO OR MORE BATTERIES) FOR SPECIFIC PURPOSES INCLUDING STARTING ENGINES, RUNNING ACCESSORIES OR EVEN RECHARGING. THEY ALLOW FOR THE USE OF ONE OR MORE BATTERIES IN SYSTEMS WITH ONE OR MORE ENGINES AND FACILITATE PUTTING BATTERIES IN PARALLEL FOR EMERGENCY STARTING WHEN ONE OR BOTH BATTERIES ARE SUBSTANTIALLY DISCHARGED.**

**ALL PERKO BATTERY DISCONNECT SWITCHES AND BATTERY SELECTOR SWITCHES ARE UL LISTED, IGNITION PROTECTED AND CE APPROVED. THIS MEANS THEY HAVE BEEN TESTED AND CERTIFIED BY A RESPECTED OUTSIDE AGENCY, ARE DESIGNED TO BE USED SAFELY IN A BILGE WHERE EXPLOSIVE FUMES MAY BE PRESENT AND MEET ALL THE REQUIREMENTS FOR USE AND SALE THROUGHOUT THE WORLD.**

**PERKO BATTERY SWITCHES ARE DESIGNED FOR SURFACE MOUNTING. STANDARD DUTY SWITCHES HAVE A BRIGHT RED POLYCARBONATE HOUSING FOR SAFETY WITH A LARGE EASY-TO-TURN BLACK KNOB. THE HOUSING OF THE HEAVY DUTY SWITCHES ARE RED FIBER-REINFORCED POLYCARBONATE. SELECTOR SWITCHES ARE DESIGNED WITH A "MAKE BEFORE BREAK" FEATURE. THIS ALLOWS SWITCHING BETWEEN THE "1", THE "ALL" AND THE "2" POSITIONS WHILE THE ENGINE IS RUNNING. MODELS WITH AN "ALTERNATOR FIELD DISCONNECT" FEATURE OFFER PROTECTION FOR NON-UNITIZED ALTERNATORS SHOULD THE SWITCH ACCIDENTALLY BE TURNED TO THE "OFF" POSITION WITH THE ENGINE RUNNING.**

**Diagram #1**

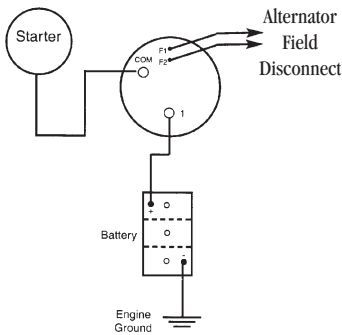

**SINGLE ENGINE - SINGLE BATTERY**

**Diagram #2**

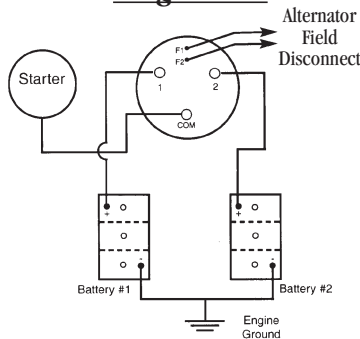

**SINGLE ENGINE - TWO BATTERIES**

Switch Position indicates which battery (#1, All, #2) is connected to engine.

**Diagram #3**

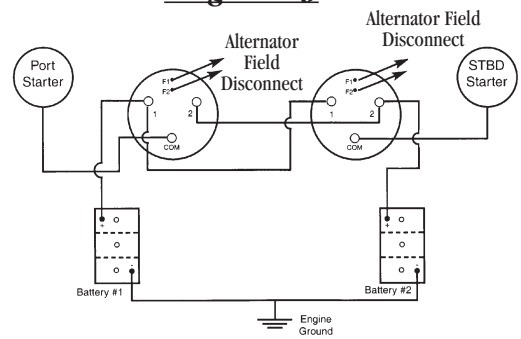

**2 ENGINES, 2 BATTERIES, 2 SWITCHES.**

This allows either engine to be started by either battery. Port switch indicates which battery (#1, All, #2) is connected to the port engine and the starboard switch indicates which battery (#1, All, #2) is connected to starboard engine.

**Diagram #4**

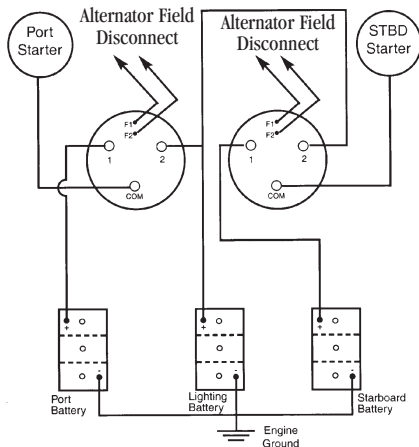

**2 ENGINES, 2 ENGINE BATTERIES,  
1 SEPARATE BANK OF LIGHTING BATTERIES  
AND 2 SWITCHES**

This allows both engines to be used to charge Lighting Batteries.

Port switch indicates which battery (port only, port lighting only) is connected to the port engine and the starboard switch indicates

### Optional Alternator Field Disconnect

- Use minimum 14 awg wire, suitable for use in marine engine compartments.
- On systems with separate regulator, splice the field disconnect switch into the field wire "F" as shown:

1. At the Regulator:

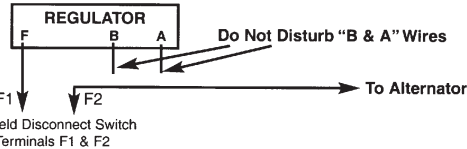

- On unitized alternators with built-in regulator and 3 wire hook-up, splice the field disconnect switch into the field wire "F" as shown"

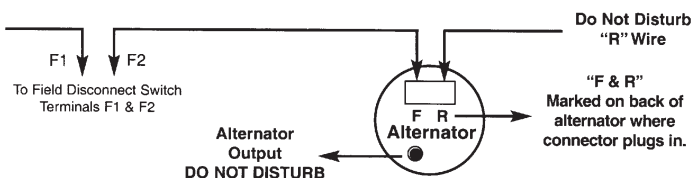

- On single wire alternators - a field disconnect cannot be installed.

Lighting Fixtures, Bulbs and Battery Switches

## BATTERY SELECTOR SWITCHES



**IGNITION PROTECTED**  
 PROTECTED BY THE FOLLOWING U.S. PATENTS; DESIGN 260,637 - 4,280,028 - 4,424,424



**FOR USE WITH SYSTEMS UNDER 50 VOLTS**  
**CAPACITY - 250 AMPS CONTINUOUS, 360 AMPS INTERMITTENT**

### FIGS. 8501/8502 - BATTERY SELECTOR SWITCHES



**Fig. 8501**

*For Dual Engine Systems, two switches are required.*



**Fig. 8502**



### FIGS. 8503/8504 - ALTERNATOR FIELD DISCONNECT MODELS



**Fig. 8503**

*When used with Non-Unitized Alternators, these models will interrupt the field current (reducing the possibility of damage) if turned "OFF" with the engine running.*



**Fig. 8504**



Lighting Fixtures, Bulbs and Battery Switches

### ORDERING INFORMATION

	Dealer Pkg. 5 Pkgs.	OEM Bulk Pkg. 25 Pcs.	Diameter Inches	Depth Inches	Ship Wt. Carton Lbs. DP/OEM Bulk Pkg.	Alternator Field Disconnect
Features:	1 Pc. per Pkg.					
Standard	8501 DP	8501	5-1/4	2-5/8	4.9/21.9	No
With Keylock	8502 DP	8502	5-1/4	2-5/8	5.2/23.1	No
Standard	8503 DP	8503	5-1/4	2-5/8	5.1/22.4	Yes
With Keylock	8504 DP	8504	5-1/4	2-5/8	5.4/23.5	Yes



**Fig. 8603**

**FIG. 8603 - HEAVY DUTY BATTERY SELECTOR SWITCH**  
**FOR USE WITH SYSTEMS UNDER 50 VOLTS**  
**CAPACITY - RATED 380 AMPS CONTINUOUS,**  
**850 AMPS INTERMITTENT (5 MINUTES ON, 5 MINUTES OFF)**

### ORDERING INFORMATION

Dimensions	Depth	Dealer Pkg.	Ship Wt.
Face	Inches	2 Pcs.	Carton Lbs.
Inches	Inches	1 Pc. per Pkg.	Dealer Pkg.
5-1/4 x 5-1/4	3-3/8	8603 DP	5.1



## MAIN BATTERY DISCONNECT SWITCHES



**IGNITION PROTECTED**  
 PROTECTED BY THE FOLLOWING U.S. PATENTS; DESIGN 260,637 - 4,280,028 - 4,424,424



**FOR USE WITH SYSTEMS UNDER 50 VOLTS**  
**CAPACITY - 250 AMPS CONTINUOUS, 360 AMPS INTERMITTENT**

### FIGS. 9601/9602 - MAIN BATTERY DISCONNECT SWITCHES



**Fig. 9601**



**Fig. 9602**

### FIGS. 9603/9604 - ALTERNATOR FIELD DISCONNECT MODELS



**Fig. 9603**

*When used with Non-Unitized Alternators, these models will interrupt the field current (reducing the possibility of damage) if turned "OFF" with the engine running.*



**Fig. 9604**



### ORDERING INFORMATION

	Dealer Pkg. 5 Pkgs.	OEM Bulk Pkg. 25 Pcs.	Diameter Inches	Depth Inches	Ship Wt. Carton Lbs. DP/OEM Bulk Pkg.	Alternator Field Disconnect
Features:	1 Pc. per Pkg.					
Standard	9601 DP	9601	5-1/4	2-5/8	4.6/20.0	No
With Keylock	9602 DP	9602	5-1/4	2-5/8	4.8/21.5	No
Standard	9603 DP	9603	5-1/4	2-5/8	4.8/20.8	Yes
With Keylock	9604 DP	9604	5-1/4	2-5/8	4.9/21.3	Yes

### FIG. 9703 - HEAVY DUTY BATTERY DISCONNECT SWITCH

**FOR USE WITH SYSTEMS UNDER 50 VOLTS**  
**CAPACITY - RATED 450 AMPS CONTINUOUS,**  
**1200 AMPS INTERMITTENT (15 SECONDS ON, 5 MINUTES OFF)**



### ORDERING INFORMATION

Dimensions Face Inches	Depth Inches	Dealer Pkg. 2 Pcs. 1 Pc. per Pkg.	Ship Wt. Carton Lbs. Dealer Pkg.
5-1/4 x 5-1/4	3-3/8	9703 DP	5.1



**Fig. 9703**

Lighting Fixtures, Bulbs and Battery Switches

## SWITCHES & SWITCH PANEL

**FIG. 517 - SWITCH PANEL**



**FIG. 517**

**CONSTRUCTION:**

- \* **BLACK PLASTIC TEXTURED FINISH**
- \* **ENGRAVED LETTERING**
- \* **RATED FOR 10 AMPS AT 12, 24 AND 32 VOLTS**
- \* **ROCKER SWITCHES, NAME PLATES AND LOW PROFILE FUSE HOLDERS FOR 1/4" X 1-1/4" FUSES INCLUDED**
- \* **WILL MOUNT ON CURVED OR FLAT SURFACES**



**ORDERING INFORMATION**

Dimensions Inches	Dealer Pkg. 5 Cards 1 Pc. per Card	Ship Wt. Carton Lbs. Dealer Pkg.
6-1/2 x 4-1/2	517 DP BLK	2.7

Screw Size #6  
Spare Fuse Holders, Cat. No. 532 DP.      Spare Rocker Switches, Cat. No. 531 DP.  
Spare Fuse Holder Cap, Cat. No. 558 DP.

Lighting Fixtures, Bulbs  
and Battery Switches



**FIG. 701**

**FIG. 701 - PUSH BUTTON SWITCH**

**CONSTRUCTION:**

- \* **BLACK PLASTIC WITH WEATHER RESISTANT COVER**
- \* **PUSH-ON, PUSH-OFF**
- \* **RATED FOR 10 AMPS AT 12, 24 AND 32 VOLTS**



**ORDERING INFORMATION**

Maximum Thickness of Panel Inches	Diameter Neck Inches	Dealer Pkg. 10 Cards 1 Pc. per Card	Ship Wt. Carton Lbs. Dealer Pkg.
1/8	3/8	701 DP	0.5



**FIG. 514**

**FIG. 514/688 - TOGGLE SWITCHES**

**CONSTRUCTION:**

- \* **NICKEL PLATED BRASS TOGGLE WITH CHROME PLATED FACE NUT**
- \* **SINGLE POLE, SINGLE THROW (OFF-ON)**
- FIG. 514 RATED FOR 6 AMPS AT 12, 24 AND 32 VOLTS**
- FIG. 688 RATED FOR 20 AMPS AT 12, 24 AND 32 VOLTS**



**ORDERING INFORMATION**

Maximum Thickness of Panel Inches	Diameter Neck Inches	Dealer Pkg. 10 Cards 1 Pc. per Card	Ship Wt. Carton Lbs. Dealer Pkg.
5/16 3/16	7/16 7/16	514 DP 688 DP NKL	0.9 0.9

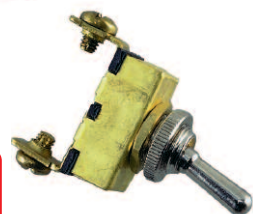

**FIG. 688**

**Important Note: None of the above Switches are Ignition Protected. See Page 90.**

## IN-LINE FUSE HOLDER, CONNECTIONS & CABLE OUTLET

**FIG. 786 - IN-LINE FUSEHOLDER**

**CONSTRUCTION:**

- \* **MOLDED PLASTIC**
- \* **RATED FOR 20 AMPS AT 12, 24 AND 32 VOLTS FOR 1/4" X 1-1/4" FUSES**
- \* **12 VOLT, 20 AMP FUSE AND 7-1/2 INCH WIRE LEAD INCLUDED**



**FIG. 786**



**ORDERING INFORMATION**

Length Inches	Diameter Inches	Dealer Pkg. 10 Cards 1 Pc. per Card	Ship Wt. Carton Lbs. Dealer Pkg.
2-1/8	11/16	786 DP	0.8

**FIGS. 1189 & 1190 - WATERTIGHT DECK CONNECTIONS**

**CONSTRUCTION:**

**FIG. 1189 - CHROME PLATED BRASS**  
**FIG. 1190 - CHROME PLATED ZINC ALLOY**

- \* **RATED FOR 15 AMPS AT 12, 24 AND 32 VOLTS POLARIZED DOUBLE CONTACT CONNECTOR**
- \* **FLANGE GASKET WITH INTEGRAL WATERPROOF CAP FOR BASE WHEN PLUG IS REMOVED**



**FIG. 1189**

**CHROME PLATED BRASS**

**FIG. 1190**

**CHROME PLATED ZINC**



**ORDERING INFORMATION**

Diameter Inches	Height Inches	Dealer Pkg. 10 Cards 1 Pc. per Card	OEM Bulk Pkg. 50 Pcs.	Screw Size	Ship Wt. Carton Lbs. DP/OEM Bulk Pkg.
1-5/8	1-3/16	1189 DP CHR	1189 000 CHR	6	1.8/6.3
1-5/8	1-3/16	1190 DP CHR	1190 000 CHR	6	1.9/7.1

Spare Connector with Cover, Cat. No. 1189 DP 99A.

Spare Connector Only, Cat. No. 42.

**Note: These Items Are Not Ignition Protected.**

**Important Note: All of the Above Items Conform to U.S.C.G. Electrical Standards. See Page 90.**

**FIGS. 424 & 1191 - WATERTIGHT CABLE OUTLETS**

**CONSTRUCTION:**

**FIG. 424, CHROME PLATED BRASS**  
**FIG. 1191, CHROME PLATED ZINC ALLOY**

- \* **FOR 5/16 INCH O.D. CABLE**
- \* **EQUIPPED WITH RUBBER GROMMET FOR WATERTIGHT PASSAGE OF CABLE**



**FIG. 424 - CHROME PLATED BRASS**

**FIG. 1191 - CHROME PLATED ZINC**



**ORDERING INFORMATION**

Diameter Base Inches	Dealer Pkg. 10 Cards 1 Pc. per Card	Screw Size	Ship Wt. Carton Lbs. Dealer Pkg.
1-1/4	424 DP CHR	6	0.9
1-1/4	1191 DP CHR	6	0.8

Lighting Fixtures, Bulbs and Battery Switches

**FIG. 196 - PLASTIC CABLE STRAP**

**CONSTRUCTION:**

- \* **BLACK PLASTIC**
- \* **ULTRA-VIOLET STABILIZED FOR WEATHER RESISTANCE**
- \* **ELIMINATES THE NEED FOR INSULATING CUSHION**



**FIG. 196**



**ORDERING INFORMATION**

I.D. Inches	Dealer Pkg. 10 Cards 10 Pcs. per Card	OEM Bulk Pkg. 500 Pcs.	Ship Wt. Carton Lbs. DP/OEM Bulk Pkg.
3/16	196 DP1	196 001	0.6/1.0
1/4	196 DP2	196 002	0.6/1.2
5/16	196 DP3	196 003	0.7/1.3
3/8	196 DP4	196 004	0.7/1.4
1/2	196 DP5	196 005	1.0/2.0
5/8	196 DP6	196 006	1.0/2.1
3/4	196 DP7	196 007	1.1/2.6

Width all sizes - 1/2 inch.

**Note: This Item Conforms to U.S.C.G. Electric Standards**



Lighting Fixtures, Bulbs and Battery Switches

**FIGS. 163, 164, 165 - LINE SUPPORT CLIPS**

**CONSTRUCTION:**

- \* **ALUMINUM WITH SYNTHETIC RUBBER CUSHION**



**FIG. 163  
SINGLE**



**FIG. 164  
DOUBLE**



**FIG. 165  
TRIPLE**



**ORDERING INFORMATION**

For O.D. Line Inches	Width Inches	Single Dealer Pkg. - 10 Cds 10 Pcs. per Card	Double Dealer Pkg. - 10 Cds 10 Pcs. per Card	Triple Dealer Pkg. - 10 Cds 10 Pcs. per Card	Ship Wt. Carton Lbs. DP Figs. 163/164/165
3/16	3/8	163 DP1 ALU	164 DP1 ALU	-----	0.8/1.0/--
1/4	3/8	163 DP2 ALU	164 DP2 ALU	-----	0.9/1.3/--
5/16	1/2	163 DP3 ALU*	164 DP3 ALU	165 DP3 ALU	1.0/1.4/1.6
3/8	1/2	163 DP4 ALU*	164 DP4 ALU	165 DP4 ALU	1.6/1.9/2.7
1/2	1/2	163 DP5 ALU	164 DP5 ALU*	165 DP5 ALU*	1.7/2.7/3.1
5/8	1/2	163 DP6 ALU*	-----	-----	2.1/--/--

\*OEM Package - 500 Pcs. Replace "DP" with "00" When Ordering.

**Note: This Item Conforms to U.S.C.G. Electric & Fuel Standards**





## SPARE BULBS FOR UTILITY LIGHTS

**FIG. 432 - SEALED BEAM UNITS**

**ORDERING INFORMATION**

Nominal Voltage	Wattage	Amps	Standard Pkg. 5 Pieces	Bulbs per Pkg.	Bulb Length Inches	Mfg. Lamp No.	Ship Wt. Carton Lbs. Standard Pkg.
12	35	3	432 001 12V	1	2-3/4	4406	0.5
24	50	2	432 002 24V	1	2-3/4	4593	0.5
32	60	2	432 003 32V	1	2-3/4	4350	0.6

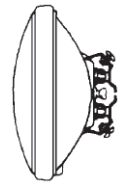

**FIG. 432**

**FIG. 337 - DOUBLE CONTACT BAYONET BASE BULB**



**CLEAR**

**ORDERING INFORMATION**

Nominal Voltage	Wattage	Amps	Dealer Pkg. 5 Cards	Bulbs per Card	Bulb Diameter Inches	Mfg. Lamp No.	Ship Wt. Carton Lbs. Dealer Pkg.
12	7	.58	337 011 DP	2	3/4	90	0.3
12	11	.94	337 012 DP	2	3/4	1004	0.4
12	17	1.44	337 013 DP	2	1	1142	0.5
24	15	.63	337 014 DP	1	1	306	0.4
32	13	.40	337 018 DP	1	3/4	624	0.3
32	14	.43	337 019 DP	1	1	1228	0.4
32	21	.66	337 020 DP	1	1	1692	0.4
32	24	.74	337 021 DP	1	1-3/8	1054	0.3
120	15	---	337 023 DP	2	7/8	15T7	0.4



**FIG. 337**



**FIG. 67 & 70 - DOUBLE ENDED FESTOON BULBS**

**CLEAR**

**NICKEL PLATED BRASS CAPS**



**ORDERING INFORMATION**

Nominal Voltage	Wattage	Amps	Dealer Pkg. 5 Cards 2 Bulbs per Card	Bulb Diameter Inches	Bulb Length Inches	Ship Wt. Carton Lbs. Dealer Pkg.
12	10	.74	70 DP0 CLR	3/8	1-11/16	0.2
12	15	.97	70 DP1 CLR	9/16	1-11/16	0.2
24	10	.42	67 DP1 CLR	3/8	1-11/16	0.2



**FIG. 70**



**FIG. 340 - MEDIUM SCREW BASE BULB**

**ORDERING INFORMATION**

Nominal Voltage	Wattage	Amps	Standard Pkg. 6 Bulbs	Type	L.C.L. Inches	Mfg. Lamp No.	Ship Wt. Carton Lbs. Std. Pkg.
12	15	1.25	340 005 FRD	A-17	2-3/8	15-A	0.5
12	25	2.08	340 006 FRD	A-19	2-9/16	25-A	0.7
12	50	4.16	340 007 FRD	A-21	3-7/16	50-A21	0.8
32	15	.47	340 011 FRD	A-17	2-3/8	15-A	0.6
32	25	.78	*340 012 FRD	A-19	2-9/16	25-A	0.3
32	50	1.56	*340 013 FRD	A-21	3-7/16	50-A21	0.2



**FIG. 340**



\*Standard Pkg. - 2 Bulbs

**Note: High Power Bulbs and Sealed Beam Units for Searchlights, See Searchlight Section.**

**ELECTRIC BULBS ARE NOT RETURNABLE. ORDER CAREFULLY.**

Lighting Fixtures, Bulbs and Battery Switches

Note: Figs. 162 & 349 Conform to A.B.Y.C. Standard A-23 in Accordance with the '72 COLREGS and U.S. Inland Rules for Use on Vessels Under 5 Meters (16.4 ft.) in Length.

### FIG. 162 - FOG HORN

#### CONSTRUCTION:

- \* ALUMINUM WITH WHITE BAKED ENAMEL FINISH
- \* NYLON MOUTHPIECE



FIG. 162



#### ORDERING INFORMATION

Length Inches	Dealer Pkg. - 10 Bags 1 Pc. per Bag	Ship Wt. Carton Lbs. Dealer Pkg.
12-1/2	162 DP WHT	1.6

### FIG. 349 - "BALL TYPE" WHISTLE

#### CONSTRUCTION:

- \* ORANGE PLASTIC



FIG. 349



#### ORDERING INFORMATION

Length Inches	Width Inches	Dealer Pkg. - 10 Cds. 1 Pc. per Card	OEM Bulk Pkg. 100 Pcs.	Ship Wt. Carton Lbs. DP/OEM Bulk Pkg.
2-1/4	3/4	349 DP	349	0.8/3.3

### FIG. 441 - PORTLIGHT CHAIN

#### CONSTRUCTION:

- \* STAINLESS STEEL CHAIN WITH CHROME PLATED FITTINGS



FIG. 441



#### ORDERING INFORMATION

Length Inches	Length Strap Inches	Dealer Pkg. 10 Cds. 1 Pc. per Card	OEM Bulk Pkg. 50 Pcs.	Screw Size	Ship Wt. Carton Lbs. DP/OEM Bulk Pkg.
7	1-7/8	441 DP CHR	441 000 CHR	8	0.6/3.9

### FIG. 461 - PORTLIGHT WEATHERSTRIPPING

#### CONSTRUCTION:

- \* OPEN CELL FOAM RUBBER
- \* SUPPLIED IN TEN FOOT LENGTHS

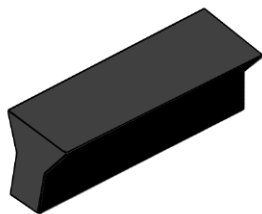

FIG. 461

#### ORDERING INFORMATION

Height Inches	Min. Width Inches	Max Width Inches	Standard Pkg. 1 Length	Ship Wt. Carton Lbs. Standard Pkg.
3/8	1/4	7/16	461	0.4

### FIG. 708 - YACHT LOG BOOK

120 PAGES 8-1/4" X 11"



FIG. 708

Log Book includes expanded Vessel and Equipment Information listings, weather symbols and a modified Beaufort wind scale, VHF radio channel assignments & marine radio procedures, marine radio log, most frequently used courses, repair & maintenance logs, an expense journal, GPS/Loran waypoint log, expanded cruising log, a diary & notes section and a friends & guest log. Cover is hard bound with a water resistant washable finish. Navy blue with gold lettering.



#### ORDERING INFORMATION

Dealer Pkg. - 5 Bags 1 Pc. per Bag	Ship Wt. Carton Lbs. Dealer Pkg.
708 DP	6.4

## COWL & CLAM SHELL VENTILATORS

**FIG. 1312 - COWL VENTILATOR**

**CHROME PLATED ZINC ALLOY COWL WITH BLACK PLASTIC BASE**  
**3" DUCT THREADS INTO NECK, HOSE CLAMPS NOT REQUIRED**



**ORDERING INFORMATION**

Mouth Opening Square Inches	Length Overall Inches	Width Overall Inches	Height Overall Inches	Dealer Pkg. 5 Cards 1 Pc. per Card	OEM Bulk Pkg. 50 Pcs.	Screw Size	Ship Wt. Carton Lbs. DP/OEM Bulk
8	5-3/4	4-3/8	2-5/8	1312 DP CHR	1312 000 CHR	8	4.8/24.4



**FIG. 1312**

**FIG. 870 - COWL VENTILATOR**

**CHROME PLATED ZINC ALLOY COWL WITH BLACK PERKO-KOTE BASE**  
**3" DUCT THREADS INTO NECK, HOSE CLAMPS NOT REQUIRED**



**ORDERING INFORMATION**

Mouth Opening Square Inches	Length Overall Inches	Width Overall Inches	Height Overall Inches	Dealer Pkg. 1 Pc	OEM Bulk Pkg. 5 Pcs.	Screw Size	Ship Wt. Carton Lbs. DP/OEM Bulk
7-1/3	5-1/8	4	3-7/8	870 DP CHR	870 000 CHR	10	1.4/6.6

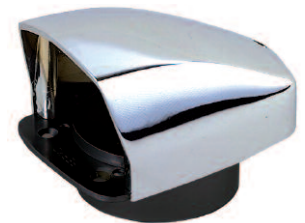

**FIG. 870**

**FIG. 510 - COWL VENTILATOR**

**POLISHED OR CHROME PLATED BRASS, CAST BRONZE DECK PLATE**  
**Internal Thumb Screw Allows Cowl to be Locked in any Position**  
**Ventilators are Painted White Inside Only**

**ORDERING INFORMATION**

Mouth I.D. Deck Plate Inches	O.D. Deck Plate Inches	Diameter Mouth Inches	Height Overall Inches	Polished Brass Standard Pkg. - 1 Pc.	Chrome Plated Brass Standard Pkg. - 1 Pc.	Screw Size	Ship Wt. Carton Lbs. Std Pol/Std Chr
4	7-1/16	8	11	510 004 POL	510 004 CHR	10	5.9/5.9



**FIG. 510**

For Spare Deck Plates, Covers and Keys; Refer to Fig. No. 526, Page 119.

**FIG. 315 - CLAM SHELL VENTILATOR**

**CHROME PLATED BRASS**



**ORDERING INFORMATION**

Mouth Dimensions Base Inches	Height Opening Inches	Width Opening Inches	Dealer Pkg. 10 Cards 1 Pc. per Card	OEM Bulk Pkg. 100 Pcs.	Screw Size	Ship Wt. Carton Lbs. DP/OEM Bulk
1-5/8 x 1-1/2	7/16	7/8	315 DP1 CHR	315 001 CHR	4	0.5/3.3
2 x 2	9/16	1-7/8	315 DP2 CHR	315 002 CHR	6	1.1/8.0



**FIG. 315**

**FIG. 339 - CLAM SHELL VENTILATOR**

**CHROME PLATED BRASS**



**ORDERING INFORMATION**

Mouth Dimensions Base Inches	Height Opening Inches	Width Opening Inches	Dealer Pkg. 5 Cards 1 Pc. per Card	OEM Bulk Pkg. 25 Pcs.	Screw Size	Ship Wt. Carton Lbs. DP/OEM Bulk
4 x 3-3/4	1-5/8	2-1/2	339 DP CHR	339 000 CHR	6	2.4/8.5



**FIG. 339**

## VENTILATORS

**FIG. 707 - VENTILATOR**



**FIG. 707**

**CONSTRUCTION:**

\* **CHROME PLATED BRASS FRAME & SCREEN**



**ORDERING INFORMATION**

	Dealer Pkg.	OEM Bulk Pkg.	Screw Size	Ship Wt. Carton Lbs. DP/OEM Bulk
Dimensions Inches	10 Cards 1 Pc. per Card	25 Pcs.	8	1.8/3.4
	707 DP CHR	707 000 CHR		

**FIG. 330 - LOCKER VENTILATOR**

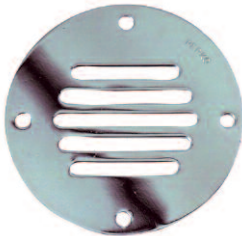

**FIG. 330**

**CONSTRUCTION:**

\* **CHROME PLATED BRASS**



**ORDERING INFORMATION**

	Dealer Pkg.	OEM Bulk Pkg.	Screw Size	Ship Wt. Carton Lbs. DP/OEM Bulk
O.D. Inches	10 Cards 1 Pc. per Card	100 Pcs.	6 R.H.	0.9/4.4
	330 DP1 CHR	330 001 CHR	6 R.H.	1.2/7.0
	330 DP2 CHR	330 002 CHR		

**FIG. 550 - TRANSOM OR LOCKER VENTILATOR**



**FIG. 550**

**CONSTRUCTION:**

\* **CHROME PLATED BRASS**



**ORDERING INFORMATION**

	Dealer Pkg.	OEM Bulk Pkg.	Screw Size	Ship Wt. Carton Lbs. DP/OEM Bulk
Dimensions Inches	10 Cards 1 Pc. per Card	25 Pcs.	8	2.3/3.8
	550 DP CHR	550 000 CHR		

**FIG. 1271 - TRANSOM OR LOCKER VENTILATOR**



**FIG. 1271**

**CONSTRUCTION:**

\* **CHROME PLATED ZINC ALLOY**

\* **ANODIZED ALUMINUM EXPANDED MESH SCREEN**



**ORDERING INFORMATION**

	Dealer Pkg.	OEM Bulk Pkg.	Screw Size	Ship Wt. Carton Lbs. DP/OEM Bulk
Dimensions Inches	10 Cards 1 Pc. per Card	25 Pcs.	8	2.4/4.4
	1271 DP CHR	1271 000 CHR		

**FIG. 1238 - TRANSOM OR LOCKER VENTILATOR**



**FIG. 1238**

**CONSTRUCTION:**

\* **CHROME PLATED ZINC ALLOY**

\* **ANODIZED ALUMINUM GRILL-TYPE SCREEN**



**ORDERING INFORMATION**

	Dealer Pkg.	OEM Bulk Pkg.	Screw Size	Ship Wt. Carton Lbs. DP/OEM Bulk
Dimensions Inches	10 Cards 1 Pc. per Card	50 Pcs.	8	3.6/12.4
	1238 DP CHR	1238 000 CHR		

## VENTILATORS

**FIG. 334 - LOUVER VENTILATOR**

**CONSTRUCTION:**

\* **CHROME PLATED BRASS**



**ORDERING INFORMATION**

Dimensions Inches	Length Louvers Inches	Dealer Pkg. 5 Cards 1 Pc. per Card	OEM Bulk Pkg. 10 Pcs.	Ship Wt. Carton Lbs. DP/OEM Bulk
3 x 2-1/2	2	334 002 DP	334 002 CHR	0.6/0.9
4 x 2-1/2	3	334 02A DP	334 02A CHR	0.7/1.1
5-1/2 x 2-1/2	2	334 004 DP	334 004 CHR	0.9/1.4
7-1/2 x 2-1/2	3	334 04A DP	334 04A CHR	1.2/1.8
8 x 2-1/2	2	334 006 DP	334 006 CHR	1.5/2.3
11 x 2-1/2	3	334 06A DP	334 06A CHR	2.1/3.2

Screw Size #4 R.H.

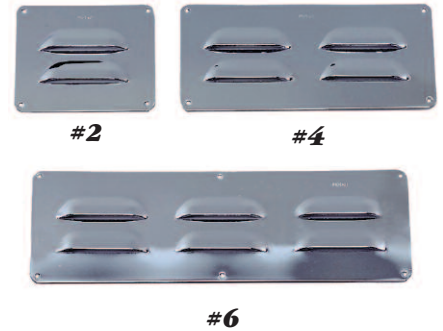

**FIG. 334**

**FIG. 335 - LOUVER VENTILATOR**

**CONSTRUCTION:**

\* **CHROME PLATED BRASS**



**ORDERING INFORMATION**

Dimensions Inches	Length Louvers Inches	Dealer Pkg. 5 Cards 1 Pc. per Card	OEM Bulk Pkg. 10 Pcs.	Ship Wt. Carton Lbs. DP/OEM Bulk
3 x 3	2	335 003 DP	335 003 CHR	0.7/1.0
4 x 3-1/2	3	335 03A DP	335 03A CHR	1.1/1.8
5-1/2 x 3	2	335 006 DP	335 006 CHR	1.2/1.9
7-1/2 x 3-1/2	3	335 06A DP	335 06A CHR	1.8/3.0
8 x 3	2	335 009 DP	335 009 CHR	1.7/2.8
11 x 3-1/2	3	335 09A DP	335 09A CHR	2.6/4.5

Screw Size #4 R.H.

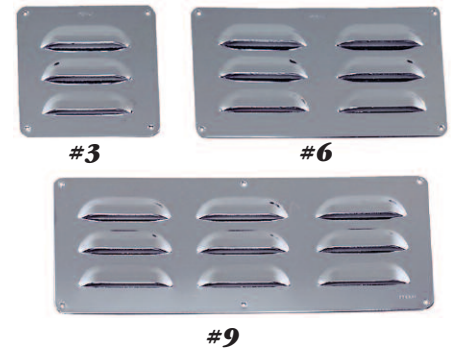

**FIG. 335**

Compartment Ventilators and Bells

**FIG. 336 - LOUVER VENTILATOR**

**CONSTRUCTION:**

\* **CHROME PLATED BRASS**



**ORDERING INFORMATION**

Dimensions Inches	Length Louvers Inches	Dealer Pkg. 5 Cards 1 Pc. per Card	OEM Bulk Pkg. 10 Pcs.	Ship Wt. Carton Lbs. DP/OEM Bulk
3-3/4 x 3	2	336 004 DP	336 004 CHR	0.9/1.5
4-3/8 x 4	3	336 04A DP	336 04A CHR	1.3/2.1
4-1/2 x 3	2	336 005 DP	336 005 CHR	1.0/1.5
5-3/8 x 4	3	336 05A DP	336 05A CHR	1.6/2.5
5-1/4 x 3	2	336 006 DP	336 006 CHR	1.2/1.8
6-3/8 x 4	3	336 06A DP	336 06A CHR	1.8/3.0

Screw Size #4 R.H.



**FIG. 336**

## FOG BELLS

**THE 8 AND 12 INCH BELLS LISTED ON THIS PAGE HAVE BEEN REVIEWED BY THE U.S. COAST GUARD AND COMPLY WITH C.G. 169 REGULATIONS FOR SOUND SIGNAL APPLIANCES AS REQUIRED BY ANNEX III PARAGRAPH 2 OF THE '72 COLREGS. THE 8 INCH SIZE IS FOR USE ON VESSELS UNDER 20 METERS (65.6 FT.) IN LENGTH. THE 12 INCH SIZE IS FOR USE ON VESSELS OF ANY LENGTH.**



**FIG. 420 POLISHED**



**FIG. 420 CHROME**

**FIG. 420 - FOG BELL**

**CONSTRUCTION OPTIONS:**

- \* POLISHED CAST BRONZE
- \* CHROME PLATED CAST BRONZE
- \* MEDIUM WEIGHT
- \* REMOVABLE

**ORDERING INFORMATION**

Bottom Diameter Inches	Height Overall Inches	Polished Bronze Std. Pkg. - 1 Pc.	Chrome Plated Bronze Std. Pkg. - 1 Pc.	Ship Wt. Carton Lbs. Std Pkg POL/CHR
6	5	420 006 POL	420 006 CHR	4.0/4.0
8	6-1/8	420 008 POL	420 008 CHR	8.1/8.1

Screw Size #8 F.H.

**FIG. 150 - FOG BELL**



**FIG. 150**

**CONSTRUCTION OPTIONS:**

- \* CAST BRONZE
- \* CHROME PLATED, PLAIN OR POLISHED
- \* HEAVY WEIGHT
- \* REMOVABLE

**ORDERING INFORMATION**

Bottom Diameter Inches	Height Overall Inches	Plain Bronze Std. Pkg. 1 Pc.	Polished Bronze Std. Pkg. 1 Pc.	Chrome Plated Bronze Std. Pkg. 1 Pc.	Ship Wt. Carton Lbs. Std Pkg. PLB/POL/CHR
8	8	150 008 PLB	150 008 POL	150 008 CHR	9.9/9.3/9.6
12	12	150 012 PLB	150 012 POL	150 012 CHR	32.0/30.9/30.9

Screw Size 1/4" F.H.

**SPARE PARTS ORDERING INFORMATION FOR PAGES 102 AND 103**

For complete Spare Part No. Insert Finish Code:

P or PLB, for Plain Bronze or Brass Finish (i.e. 420 P06 99A or 127 000 PLB).  
 B or POL, for Polished Bronze or Brass Finish (i.e. 420 B06 99A or 127 000 POL).  
 C or CHR, for Chrome Plated Finish (i.e. 420 C06 99A or 127 000 CHR).

ARMS		WALL PLATES		CLAPPERS		EYE BOLTS		ACORN NUTS	
Figure No.	Spare Part No.	Figure No.	Spare Part No.	Figure No.	Spare Part No.	Figure No.	Spare Part No.	Figure No.	Spare Part No.
420-6"	420-99A-6"	420-6"	127	420-6"	153	420-6"	113	420-6"	465 004
420-8"	171	420-8"	127	420-8"	144	420-8"	123	420-8"	465 008
150-8"	171	150-8"	127	150-8"	144	150-8"	123	150-8"	465 008
150-12"	150-99A-12"	150-12"	150-99B-12"	150-12"	172	150-12"	172	150-12"	465 009
*158-12"	158-99A-12"	*158-12"	158-99A-12"	*158-12"	172	*158-12"	172	158-12"	465 009
179	179-000-99A	179	179-000-99A	179	144	179	179-99B	179	465 008
159-6"	159-99A	159-6"	166	159-6"	159-99B	159-6"	113	159-6"	465 004
159-8"	159-99A	159-8"	166	159-8"	153	159-8"	113	159-8"	465 004

\*Includes Wall Bracket

\*Includes Arm

\*Includes Eye Bolt

\*Includes Clapper

## FOG BELLS

**THE 8 AND 12 INCH BELLS LISTED ON THIS PAGE HAVE BEEN REVIEWED BY THE U.S. COAST GUARD AND COMPLY WITH C.G. 169 REGULATIONS FOR SOUND SIGNAL APPLIANCES AS REQUIRED BY ANNEX III PARAGRAPH 2 OF THE '72 COLREGS. THE 8 INCH SIZE IS FOR USE ON VESSELS UNDER 20 METERS (65.6 FT.) IN LENGTH. THE 12 INCH SIZE IS FOR USE ON VESSELS OF ANY LENGTH.**

**FIG. 158 - FOG BELL**

- CONSTRUCTION OPTIONS:**
- \* **PLAIN, POLISHED OR CHROME PLATED CAST BRONZE**
  - \* **HEAVY WEIGHT**
  - \* **FIXED MOUNTING**



**FIG. 158 POLISHED**

**ORDERING INFORMATION**

Bottom Diameter Inches	Height Overall Inches	Plain Bronze Std. Pkg.1 Pc.	Polished Bronze Std. Pkg.1 Pc.	Chrome Plated Bronze Std. Pkg.1 Pc.	Ship Wt. Carton Lbs. Std. Pkg. PLB/POL/CHR
12	12	158 012 PLB	158 012 POL	158 012 CHR	34.4/33.0/33.2

Screw Size 1/4" R.H.

**FIG. 179 - FOG BELL**

- CONSTRUCTION OPTIONS:**
- \* **WROUGHT BRASS**
  - \* **PLAIN BRASS FINISH**
  - \* **LIGHT WEIGHT**
  - \* **FIXED MOUNTING**



**FIG. 179**

**ORDERING INFORMATION**

Bottom Diameter Inches	Height Overall Inches	Standard Pkg. - 1 Pc.	Ship Wt. Carton Lbs. Std. Pkg.
12	8	179 012 PLB	7.6

Screw Size #12 R.H.

**FIG. 159 - FOG BELL**

- CONSTRUCTION OPTIONS:**
- \* **STAMPED BRASS**
  - \* **PLAIN OR CHROME PLATED BRASS FINISH**
  - \* **LIGHT WEIGHT**
  - \* **REMOVABLE**



**FIG. 159 CHROME**



**ORDERING INFORMATION**

Bottom Diameter Inches	Height Overall Inches	Chrome Plated Dealer Pkg. - 2 Pcs. 1 Pc. per Pkg.	Plain Brass Dealer Pkg. - 2 Pcs. 1 Pc. per Pkg.	Ship Wt. Carton Lbs. DP CHR/PLB
6	4	159 DP6 CHR	159 DP6 PLB	3.7/3.7
8	5	159 DP8 CHR	159 DP8 PLB	6.2/6.0

Screw Size #4 F.H.



**FIG. 159 PLAIN**

### THE NEWEST MEMBER OF THE PERKO UNDERWATER HARDWARE TEAM

New Product

FlushPro™



### UNDERWATER HARDWARE PACKAGING

Here is the newest member of the Perko packaging program - the Perko hang tag. These durable little tags have everything a retailer needs to showcase products and ring up sales. On each tag you will find the Perko name colorfully printed in blue, our figure number, a product description and the bar code for your scanner. There is even a California Proposition 65 statement (where applicable) on the back. These tags are designed to securely hold on to the product and hang from your standard peg hooks. And since the tags are small, you can also simply toss them into a bulk bin if you prefer. Either way, the tags will stay attached, unlike stickers that fall off bronze parts. These tags are available on thru hulls, adapters and several types of strainers. Look for the "DP" designation. Our "DP" Dealer Package for small items (like the smaller thru hull fittings and tailpieces) will be a 5 or 10 piece bulk box with a bar code label on each individual unit. **THESE 10 PIECE CARTONS CANNOT BE BROKEN.** Larger items (like valves & strainers) will be available individually boxed as a single unit standard package with a bar code label on the outside of the box.

*To be sure the parts you receive are bar coded for Retail Sale, order either a "DP" version or a single unit standard package.*

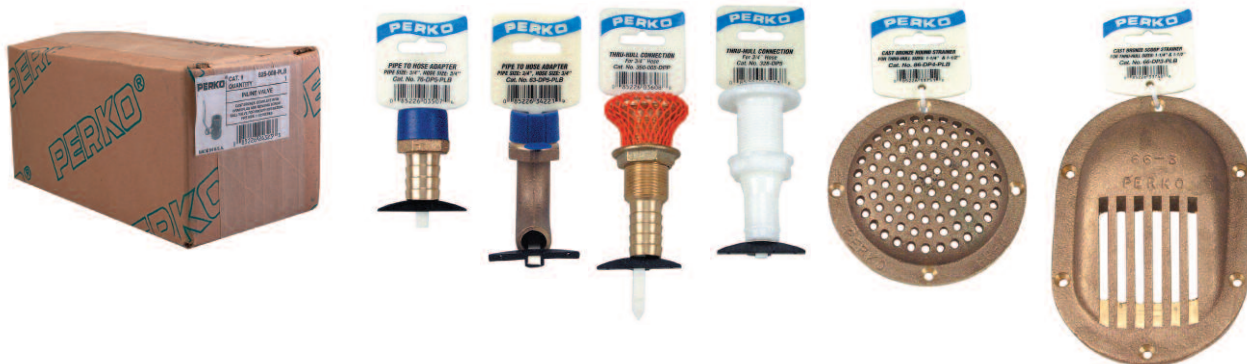

All of our small repair/replacement strainer parts are now bar coded. Top Castings (99A), Bottom Castings (99B), Transparent Cylinders (99C), Strainer Baskets (99D) and Covers (99E) are available individually boxed as bar coded single unit standard packages. Smaller items or kits including Cover Hardware Kits (99L), Gasket Kits (99M & 99R) and Tie Rod Kits (99P) are individually packaged as "DP" items in bags with a bar code label.

Underwater Hdwe, Deck Plates, Fills and Vents



## UNDERWATER HARDWARE PIPE THREAD STYLES

### Straight Pipe Threads

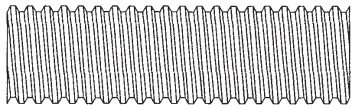

### Tapered Pipe Threads

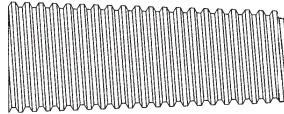

### Combination Tapered/Straight Pipe Threads

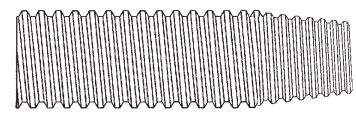

## FLUSH PRO™

**FIG. 456 - FLUSH PRO™ MARINE ENGINE FLUSHING & WINTERIZING VALVE**  
**FIG. 457 - FLUSH PRO™ MARINE ENGINE FLUSHING & WINTERIZING VALVE & KIT**

### CONSTRUCTION:

- \* PLASTIC
- \* STAINLESS STEEL SPRING
- \* AVAILABLE FOR STANDARD 5/8", 1" OR 1-1/4" HOSE SIZES



**FINALLY! FRESHWATER FLUSHING OF YOUR INBOARD IS AS SIMPLE AS CONNECTING A GARDEN HOSE**



FIG. 456

- \* FLUSH YOUR BOAT ENGINE SAFELY AND EASILY
- \* TRANSPARENT BODY ALLOWS FOR VISUAL INSPECTION OF WATER FLOW
- \* DURABLE CHECK VALVE SYSTEM ACTIVATED BY WATER PRESSURE FROM A GARDEN HOSE
- \* CHECK VALVE AUTOMATICALLY SHUTS OFF HULL INTAKE WHEN WATER PRESSURE IS APPLIED
- \* ADAPTER SUPPLIED WITH FLUSHPRO™ MAKES WINTERIZING YOUR BOAT EASY
- \* CAN BE USED WITH ONBOARD GENERATORS

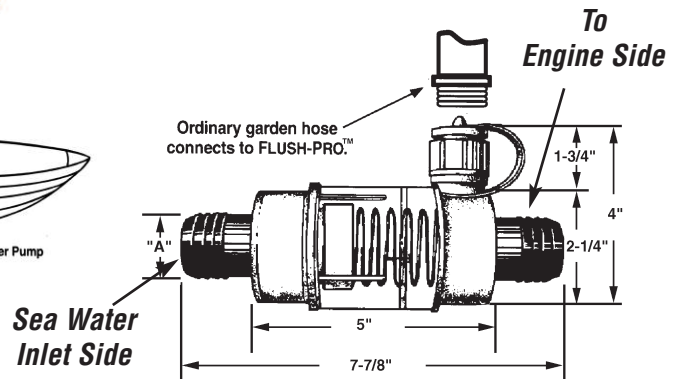
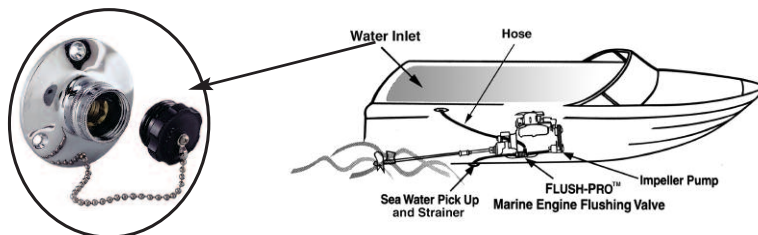

Underwater Hdw, Deck Plates, Fills and Vents



### ORDERING INFORMATION

Includes	"A" Dimension For Hose Size Inches	Dealer Pkg 1 Pc.	OEM Bulk Pkg. 5 Pcs.	Ship Wt. Carton Lbs. DP/OEM Bulk Pkg.
Valve	5/8	456 DP4	456 004	1.6/4.2
Valve	1	456 DP6	456 006	1.5/4.3
Valve	1-1/4	456 DP7	456 007	1.5/4.3
Valve & Kit*	5/8	457 DP4	457 004	3.1/12.4
Valve & Kit*	1	457 DP6	457 006	3.2/12.8
Valve & Kit*	1-1/4	457 DP7	457 007	3.1/12.4

### \*FlushPro™ Kit includes: Qty Description

- 1 FlushPro™ Check Valve with Hose Clamps.
- 1 PERKO Water Inlet Fitting Cat. No. 499 DP CHR .
- 1 7 Ft. Length of Hose and Fittings.

## INTAKE WATER STRAINERS

**FIGS. 493 & 500 - INTAKE WATER STRAINERS**

**CONSTRUCTION:**

**\* CAST BRONZE**

**PERKO WATER STRAINERS ARE DESIGNED FOR EASY INSTALLATION AND CLEANING. FEATURES INCLUDE MOUNTING LUGS CAST INTO BOTH SIDES TO ASSURE UNIVERSAL MOUNTING, FOUR OUTSIDE TIE RODS AND A 316 STAINLESS STEEL STRAINER BASKET TO MINIMIZE ELECTROLYSIS. SCREEN HOLE SIZE DIAMETER .077 INCHES, 46% OPEN AREA. HINGED LUGS FOR THE CAST BRONZE COVER PERMIT EASY REMOVAL AND CLEANING OF THE STRAINER BASKET. A DRAIN PLUG IN THE BOTTOM CASTING IS PROVIDED FOR EASILY REMOVING SEDIMENT AND DRAINING FOR WINTERIZING.**

**FOR APPLICATIONS REQUIRING HIGHER CAPACITY SEE FIG. 500 BELOW**



**Fig. 493**



**Fig. 500**

**ORDERING INFORMATION FOR FIG. 493**

Pipe Size	Height Overall	Width Overall	Standard Pkg. - 1 Pc.	Dimensions Cylinder	Dimensions Basket	Open Area To Pipe Size Ratio	Ship Wt. Carton Lbs. Standard Pkg.	Spare Gasket Kit* Dealer Pkg. - 5 kits 1 Kit. per Bag
1/2	5-3/4	4-1/2	493 004 PLB	3-1/2 x 4	1-13/16 x 4-3/8	30:1	4.7	493 DP5 99M (or) 99R
3/4	8-3/8	4-1/2	493 005 PLB	3-1/2 x 6	1-13/16 x 6-1/4	25:1	5.1	493 DP5 99M (or) 99R
1	9-1/2	5-1/2	493 006 PLB	4-1/2 x 5-1/2	2-5/8 x 5-7/8	20:1	8.0	493 DP7 99M (or) 99R
1-1/4	10	5-1/2	493 007 PLB	4-1/2 x 6	2-5/8 x 6-1/4	13:1	8.0	493 DP7 99M (or) 99R
1-1/2	11-1/2	7-1/4	493 008 PLB	6 x 8	3-5/16 x 8-7/16	17:1	14.0	493 DP9 99M (or) 99R
2	16	7-1/2	493 009 PLB	6 x 12	3-5/16 x 12-1/4	13:1	18.0	493 DP9 99M (or) 99R
2-1/2	16	7-1/2	493 010 PLB	6 x 12	3-5/16 x 12-1/2	10:1	18.0	493 DP9 99M (or) 99R

**ORDERING INFORMATION FOR FIG. 500**

Pipe Size	Height Overall	Width Overall	Standard Pkg. - 1 Pc.	Dimensions Cylinder	Dimensions Basket	Open Area To Pipe Size Ratio	Ship Wt. Carton Lbs. Standard Pkg.	Spare Gasket Kit* Standard Pkg. - 1 kit
2	14-1/2	9	500 009 PLB	8 x 10	3-7/8 x 10-1/4	20:1	36.2	500 DP9 99M (or) 99R
2-1/2	16-1/2	9	500 010 PLB	8 x 12	3-7/8 x 12-1/4	18:1	35.0	500 DP9 99M (or) 99R
3	18-1/2	9	500 011 PLB	8 x 14	3-7/8 x 14-1/4	14:1	34.6	500 DP9 99M (or) 99R

\*Spare Gasket Kit Consists of: 1 - Cover Gasket and 2 - Cylinder Gaskets.

**INTAKE WATER STRAINER SPARE PARTS ORDERING INFORMATION**

For Spare Part No. Insert a Spare Part Code Listed Below in Place of the "PLB" in the Strainer's Catalog Number (i.e., 493 006 99A, Top Casting for 1" Strainer).

Description	Spare Part Code	Sample Part Number	Package	Description	Spare Part Code	Sample Part Number	Package
Top Casting	.99A	493 004 99A	Boxed	Cork Gasket Kit Consists of: 1- Cover Gasket and 2- Cork Cylinder Gaskets	.99M*	493 DP5 99M	Bag
Bottom Casting	.99B	493 004 99B	Boxed		Rubber Gasket Kit Consists of: 1- Cover Gasket and 2- Rubber Cylinder Gaskets	.99R*	493 DP5 99R
Transparent Cylinder	.99C	493 004 99C	Boxed	Tie Rods, Nuts and Washers Consists of (4 Each for 493 Series) (1 Each for 500 Series)		.99P	493 DP4 99P
Basket Strainer	.99D	493 004 99D	Boxed				
Cover with Gasket	.99E	493 004 99E	Boxed				
Hinged Bolt for Cover							
With Pin, Nut and Washer	.99L	493 DP5 99L	Bag				
Cork Cover Gasket Kit (Set of 2)	.99N	493 DP5 99N	Bag				

\*Note Older Model strainers utilizing cork cylinder gaskets must order 99M - Cork Gasket Kit, and newer model strainers must order 99R - Rubber Gasket Kit

Underwater Hdwe, Deck Plates, Fills and Vents

## INTAKE WATER STRAINERS

**FIGS. 493 & 500 - INTAKE WATER STRAINERS SPARE PARTS ORDERING INFORMATION**

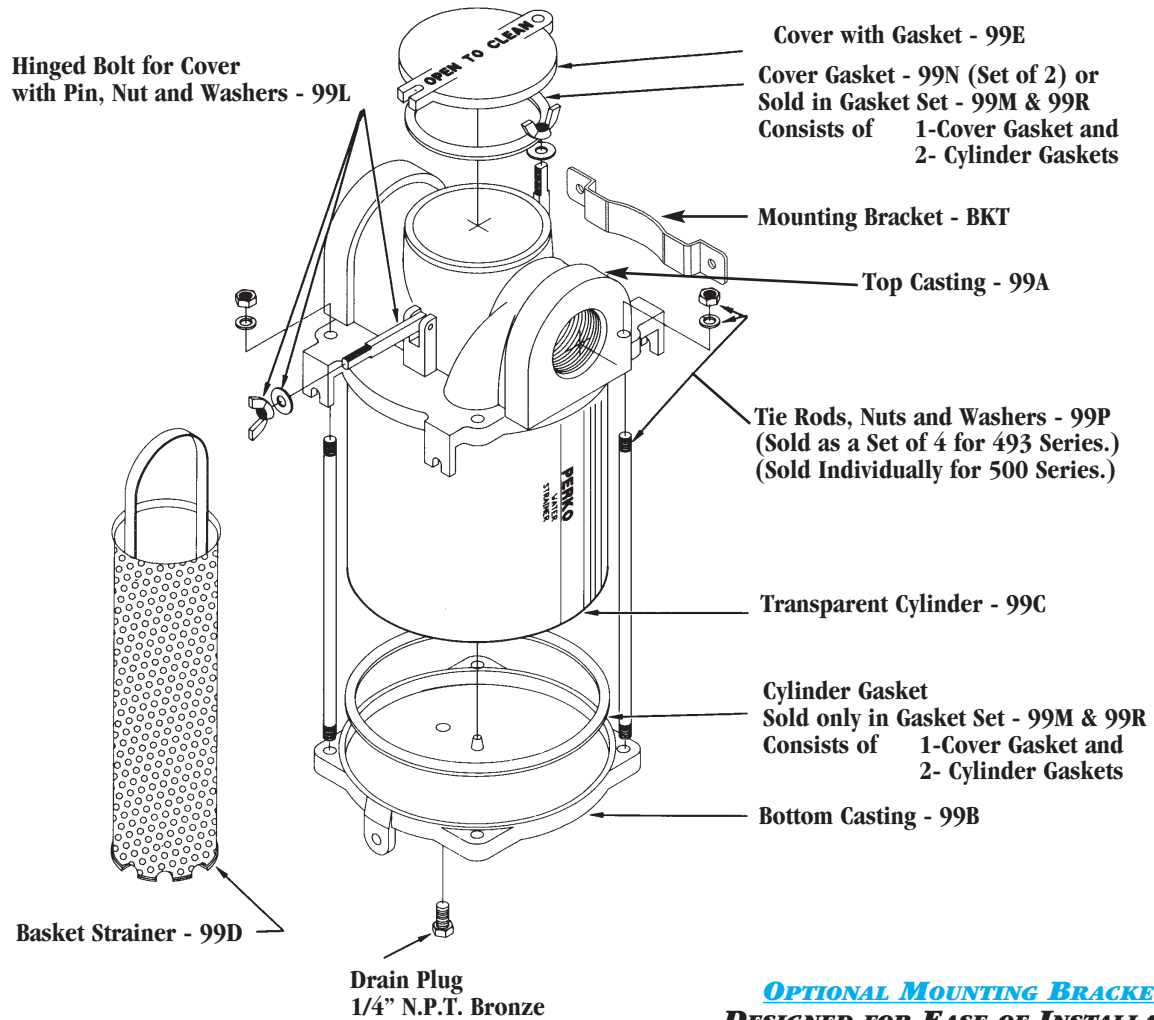

**OPTIONAL MOUNTING BRACKET.**  
**DESIGNED FOR EASE OF INSTALLATION OF FIG. 493 SERIES WATER STRAINERS**



PART NUMBER	FITS STRAINER SIZE
493 045 BKT	4 & 5
493 067 BKT	6 & 7
493 089 BKT	9

**FIGS. 493 & 500 - DIFFERENTIAL PRESSURE GRAPHS**

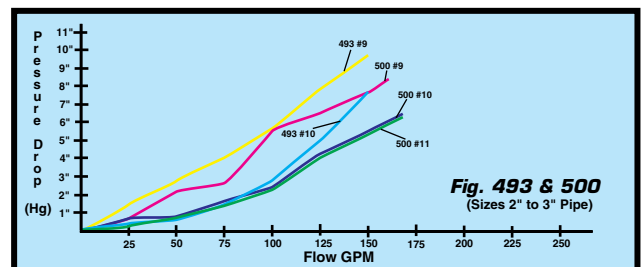
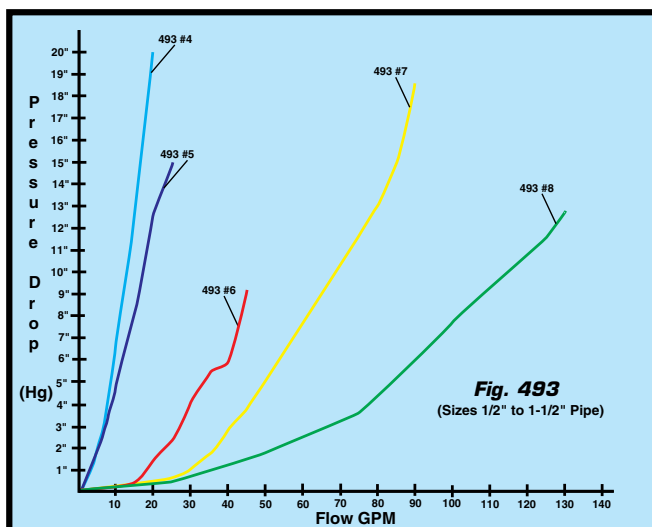

**Underwater Hdw, Deck Plates, Fills and Vents**



**Fig. 65**

**FIG. 65 - INTAKE STRAINER**

**CONSTRUCTION:**

- \* **CAST BRONZE**
- \* **MACHINED SLOTS**



**ORDERING INFORMATION**

Max. Pipe Size Inches	Max. Hull Thickness Inches	Dimensions Strainer Inches	Dealer Pkg. 5 Pcs	OEM Bulk Pkg. 10 Pcs.	Ship Wt. Carton Lbs. DP/OEM Bulk
1/2	2-1/4	3 x 4	65 DP4 PLB	65 004 PLB	3.5/7.0
3/4	2-3/16	3 x 4	65 DP5 PLB	65 005 PLB	5.6/11.0
1	2-1/2	3 x 4	65 DP6 PLB	65 006 PLB	5.9/12.1
1-1/4	3	3-1/4 x 4-1/4	65 DP7 PLB	65 007 PLB	8.2/16.7

Screw Size #8.  
Spare Flanged Nut See Fig. 75, on page 118



**Fig. 66**

**FIG. 66 - SCOOP STRAINER**

**CONSTRUCTION:**

- \* **CAST BRONZE**
- \* **MACHINED SLOTS**



**ORDERING INFORMATION**

For Thru-Hull Sizes Inches	Dimensions Strainer Inches	Dealer Pkg. 5 Pcs	Standard Package - 5 Pc.	Ship Wt. Carton Lbs. DP/Std. Pkg.
3/8 & 1/2	3-1/2 x 2-1/2	66 DP1 PLB	66 001 PLB	1.9/1.9
3/4 & 1	5 x 3-1/4	66 DP2 PLB	66 002 PLB	4.3/4.2
1-1/4 & 1-1/2	6-1/4 x 4-1/4	66 DP3 PLB	66 003 PLB	6.5/6.1
2	8 x 5-1/8	66 DP4 PLB	66 004 PLB	10.2/10.2

Screw Size #8.



**Fig. 86**

**FIG. 86 - ROUND STRAINER**

**CONSTRUCTION:**

- \* **CAST BRONZE**
- \* **DRILLED HOLES**



**ORDERING INFORMATION**

For Thru-Hull Sizes Inches	O.D. Inches	I.D. Inches	Dealer Pkg. 5 Pcs.	Standard Package - 5 Pcs.	Screw Size	Ship Wt. Carton Lbs. DP/Std. Pkg.
3/8 & 1/2	2-1/2	1-5/8	86 DP1 PLB	86 001 PLB	8	0.9/0.8
3/4	3	2	86 DP2 PLB	**86 002 PLB	8	2.2/8.8
1	3-1/2	2-3/8	86 DP3 PLB	86 003 PLB	8	1.9/1.6
1-1/4 & 1-1/2	4	3	86 DP4 PLB	86 004 PLB	8	2.8/2.7
2	5	3-3/4	86 DP5 PLB	86 005 PLB	8	4.3/4.3
2-1/2	6	4-1/2	-----	*86 006 PLB	10	---/1.2
3	8	6-1/4	-----	*86 007 PLB	10	---/2.7

\* Standard Package - 1 pc.  
\*\* Standard Package - 25 pcs.



Underwater Hdwe, Deck Plates, Fills and Vents

## PUMP STRAINERS & GARBOARD DRAIN PLUG

**FIG. 709 - PUMP STRAINER**

**CONSTRUCTION:**

**\* CAST BRONZE**



**ORDERING INFORMATION**

Hose Size Inches	Length Overall Inches	Width Overall Inches	Dealer Pkg. 5 Pcs.	Ship Wt. Carton Lbs. Dealer Pkg.
5/8	3-5/8	1-3/4	709 DP PLB	2.7

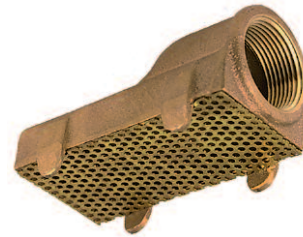

**FIG. 709**

**FIGS. 721 & 722 - PUMP STRAINERS**

**CONSTRUCTION:**

**\* CAST BRONZE**



**FIG. 721**

**ORDERING INFORMATION**

Pipe Size Inches	Length Overall Inches	Width Overall Inches	Standard Package - 1 Pc.	Ship Wt. Carton Lbs. Standard Pkg.
1-1/4	4-3/4	2-3/4	721 000 PLB	1.6
1-1/4	4-1/2	2-3/4	722 000 PLB	1.6

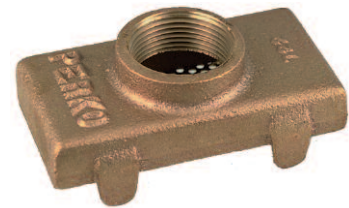

**FIG. 722**

**FIG. 124 - GARBOARD DRAIN PLUG**

**CONSTRUCTION:**

**\* CAST BRONZE FLANGE**

**\* BRASS PLUG**

**\* COMPLETE WITH ZINC ALLOY PLATED STEEL WRENCH**



Underwater Hdw, Deck Plates, Fills and Vents

**ORDERING INFORMATION**

Pipe Size Inches	Length Threaded Neck Inches	O.D. Flange Inches	Standard Package - 5 Pcs.	Screw Size	Ship Wt. Carton Lbs. Standard Pkg.
1	1	3-1/8	124 000 PLB	10	5.9

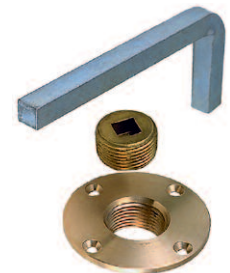

**FIG. 124**

Spare Wrench, Cat. No. 124 000 99A.

Spare Plug, Cat. No. 124 000 99B.

## GARBOARD DRAIN PLUGS

**FIG. 266 - GARBOARD DRAIN PLUG**



**FIG. 266**

**CONSTRUCTION:**

\* **CAST BRONZE**



**ORDERING INFORMATION**

Pipe Size Inches	Length Threaded Neck Inches	O.D. Flange Inches	Dealer Pkg. 5 Cards 1 Pc. per Card	OEM Bulk Pkg. 25 Pcs.	Screw Size	Ship Wt. Carton Lbs. DP/OEM Bulk
3/4	5/8	2-3/8	266 DP PLB	266 000 PLB	8	4.5/17.9

Spare Plug, Cat. No. 370 DP PLB.

**FIG. 363 - GARBOARD DRAIN PLUG**



**FIG. 363**

**CONSTRUCTION:**

\* **CAST BRONZE**



**ORDERING INFORMATION**

Pipe Size Inches	Maximum Hull Thickness Inches	Length Threaded Neck Inches	O.D. Flange Inches	Dealer Pkg. 5 Cards 1 Pc. per Card	OEM Bulk Pkg. 25 Pcs.	Ship Wt. Carton Lbs. DP/OEM Bulk
3/4	3/4	1-1/4	2-3/8	363 DP PLB	363 000 PLB	5.4/22.3

Spare Plug, Cat. No. 370 DP PLB.

**FIGS. 714 & 737 - GARBOARD DRAIN PLUGS**

**CONSTRUCTION:**

\* **CAST BRONZE FLANGE WITH BRASS PLUG**  
**NO. 2 STYLE HAS STAINLESS STEEL PIN**

**FIG. 737**

Complete with Brass Backing Plate and Fasteners.



**FIG. 714 No. 1**



**FIG. 714 No. 2**



**FIG. 737 No. 1**



**FIG. 737 No. 2**

**ORDERING INFORMATION**



Pipe Size Inches	O.D. Flange Inches	Dealer Pkg. 5 Cards 1 Pc. per Card	OEM Bulk Pkg. 50 Pcs.	Screw Size	Ship Wt. Carton Lbs. DP/ OEM Bulk
1/2	2	714 DP1 PLB	714 001 PLB	8	1.6/12.2
1/2	2	714 DP2 PLB	714 002 PLB	8	1.5/12.8

Pipe Size Inches	Hull Thickness Inches	O.D. Flange Inches	Display Pkg. 5 Cards 1 Pc. per Card	Screw Size	Ship Wt. Carton Lbs. Display Pack
1/2	7/16	2	737 DP1 PLB	8-32	2.1
1/2	7/16	2	737 DP2 PLB	8-32	2.2

Spare No. 1 Plug, Cat. No. 742 DP1.

Spare No. 2 Plug, Cat. No. 742 DP2.

Underwater Hdwe, Deck Plates, Fills and Vents

## SEACOCKS

### FIGS. 834 & 835 - SEACOCKS - BALL VALVE DESIGN

**CONSTRUCTION:**

**\* CAST BRONZE**

**FIG. 834 - WITH 90° CURVED HOSE ADAPTER**

**FIG. 835 - WITH STRAIGHT HOSE ADAPTER**

Includes Thru-Hull, Hose Adapter, Drain Plug,  
Four Pre-Drilled Mounting Holes and Bonding Screw.

PERKO Seacocks Incorporate a Plastic Ball and Seat  
Assuring a Tight Seal and Ease of Operation.  
Drain Plugs for Winterizing. Handles are Easily Removed.

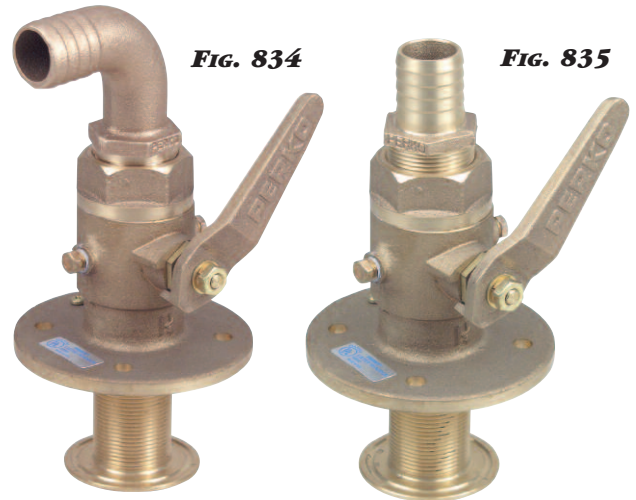

### ORDERING INFORMATION

Hose Size Inches	Pipe Size Inches	Flange Dia. Inches	Fig. 834 Overall Height*	Fig. 834 Standard Pkg. - 1 Pc	Ship Wt. Carton Lbs. Standard Pkg	Fig. 835 Overall Height*	Fig. 835 Standard Pkg. - 1 Pc.	Bolt Size	Ship Wt. Carton Lbs. Standard Pkg
3/4	3/4	3-1/4	5-7/8	834 005 PLB	3.1	5	835 005 PLB	5/16	2.9
1	1	4-3/8	6-3/8	834 006 PLB	4.9	5-3/8	835 006 PLB	3/8	5.0
1-1/4	1-1/4	4-7/8	7-5/8	834 007 PLB	7.0	6-1/4	835 007 PLB	3/8	6.1
1-1/2	1-1/2	5-1/2	8-3/8	834 008 PLB	9.0	6-5/8	835 008 PLB	3/8	8.2
2	2	5-3/4	10-3/8	834 009 PLB	13.5	7-7/8	835 009 PLB	3/8	13.5
2-1/2	2-1/2	7-1/4	12-1/2	834 010 PLB	25.0	10-3/8	835 010 PLB	1/2	25.0
3	3	8	14-3/8	834 011 PLB	32.0	12	835 011 PLB	1/2	32.0

\* Overall Height is measured from the top of the hose adapter to the bottom of the flange.

### FIG. 805 - SEACOCK BODY - BALL VALVE DESIGN

**CONSTRUCTION:**

**\* CAST BRONZE**

These Valve Bodies are Offered to Meet the Needs of Applications  
that Require Extra Long, Scoop or Flush Type Thru-Hulls.

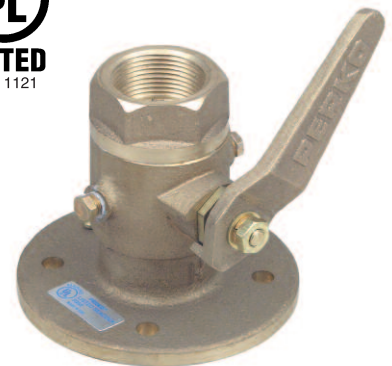

**FIG. 805**

### ORDERING INFORMATION

Flange Diameter Inches	Overall Height Inches*	Pipe Size Inches	Fig. 805 Standard Pkg. - 1 Pc.	Ship Wt. Carton Lbs. Standard Pkg
3-1/4	3-3/8	3/4	805 005 PLB	2.3
4-3/8	3-3/4	1	805 006 PLB	3.9
4-7/8	4-1/4	1-1/4	805 007 PLB	5.3
5-1/2	4-1/2	1-1/2	805 008 PLB	6.4
5-3/4	5-3/4	2	805 009 PLB	11.0
7-1/4	7-1/2	2-1/2	805 010 PLB	19.3
8	7-3/4	3	805 011 PLB	21.2

\* Overall Height is measured from the top of the valve body to the bottom of the flange.

### SPARE PARTS ORDERING INFORMATION

The Repair Kits Listed Below Consist of: 1 Ball, 2 Ball Seats and 2 O-Rings for the Valve Stem.

Pipe Size Inches	Repair Kit	Pipe Size Inches	Repair Kit	Pipe Size Inches	Repair Kit
3/4	805 005 99B	1-1/2	805 008 99B	3	805 011 99B
1	805 006 99B	2	805 009 99B		
1-1/4	805 007 99B	2-1/2	805 010 99B		

Underwater Hdw., Deck  
Plates, Fills and Vents

## IN LINE VALVE & PIPE TO HOSE ADAPTERS

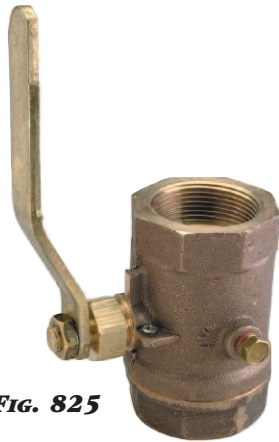

Fig. 825

Fig. 825 - INLINE VALVE

**CONSTRUCTION:**

- \* CAST BRONZE
- \* DRAIN PLUG AND BONDING SCREW INCLUDED
- \* BALL VALVE FOR SMOOTH OPERATION

**ORDERING INFORMATION**

Pipe Size Inches	Standard Package - 1 Pc.	OEM Bulk Pkg.	Ship Wt. Carton Lbs. Std Pkg./OEM Bulk
1/2	825 004 PLB	10	0.9/9.0
3/4	825 005 PLB	10	1.1/11.0
1	825 006 PLB	10	1.8/18.0
1-1/4	825 007 PLB	10	2.8/28.0
1-1/2	825 008 PLB	5	4.1/20.5



IMPROVED  
PRODUCT

Fig. 63 - PIPE TO HOSE ADAPTER

**CONSTRUCTION:**

- \* CAST BRONZE
- \* CAST HEX FOR EASIER INSTALLATION
- \* CURVED 90 DEGREES



Fig. 63

**ORDERING INFORMATION**

Pipe Size Inches	Hose Size Inches	Length Overall Inches	Dealer Pkg. 5 Pcs.	Standard Package 1 Pc.	OEM Bulk Pkg.	OEM Bulk Pkg. Pcs.	Ship Wt. Carton Lbs. DP/ Std/OEM Bulk
3/4	3/4	4-1/2	63 DP5 PLB	-----	63 005 PLB	25	2.5/--/9.6
1	1	4-3/4	63 DP6 PLB	-----	63 006 PLB	25	3.2/--/16.0
1-1/4	1-1/4	5-1/2	63 DP7 PLB	-----	63 007 PLB	25	5.1/--/25.2
1-1/2	1-1/2	6	63 DP8 PLB	-----	63 008 PLB	10	6.7/--/13.5
2	2	7	-----	63 009 PLB	63 009 PLB	10	--/2.7/25.0
2-1/2	2-1/2	8-1/2	-----	63 010 PLB	-----	---	--/3.7/--
3	3	10	-----	63 011 PLB	-----	---	--/6.7/--

NOTE: The Above Item Meets the Requirements of U.S.C.G. Safety Standards, January 31, 1977 for Gasoline Fuel Systems, 33CFR183.



Underwater Hdwe, Deck  
Plates, Fills and Vents



IMPROVED  
PRODUCT

Fig. 76 - PIPE TO HOSE ADAPTER

**CONSTRUCTION:**

- \* CAST BRONZE
- \* CAST HEX FOR EASIER INSTALLATION
- \* PRECISION MACHINED HOSE BARB



Fig. 76

**ORDERING INFORMATION**

Pipe Size Inches	Hose Size Inches	Length Overall Inches	Dealer Pkg. 5 Pcs.	Standard Pkg. - 1 Pc.	OEM Bulk Pkg. 25 Pcs.	Ship Wt. Carton Lbs. DP/Std/OEM Bulk
1/2	5/8	1-5/8	76 DP4 PLB	-----	76 004 PLB	0.7/--/3.6
3/4	3/4	1-3/4	76 DP5 PLB	-----	76 005 PLB	1.9/--/4.7
1	1	1-3/4	76 DP6 PLB	-----	76 006 PLB	1.7/--/7.8
1-1/4	1-1/4	2	76 DP7 PLB	-----	76 007 PLB	2.6/--/11.6
1-1/2	1-1/2	2-1/4	76 DP8 PLB	-----	76 008 PLB	3.7/--/18.2
2	2	2-5/8	-----	76 009 PLB	-----	--/1.2/--
2-1/2	2-1/2	4	-----	76 010 PLB	-----	--/1.8/--
3	3	5-1/8	-----	76 011 PLB	-----	--/3.0/--

NOTE: The Above Item Meets the Requirements of U.S.C.G. Safety Standards, January 31, 1977 for Gasoline Fuel Systems, 33CFR183.





## THRU-HULL CONNECTIONS

**FIG. 350 - THRU-HULL CONNECTION FOR USE WITH HOSE\*\***

**CONSTRUCTION OPTIONS:**

- \* **CAST BRONZE, PLAIN OR CHROME PLATED**
- \* **REGULAR OR SHORT LENGTH VERSIONS**



**FLANGE IS MACHINED TO FIT HULL AND GROOVED TO RETAIN BEDDING COMPOUND.  
NECK IS THREADED TO APPROXIMATELY 3/16 INCH FROM FLANGE.**

**REGULAR LENGTH** - Fits Maximum Hull Thickness up to 2 Inches.  
**SHORT LENGTH** - For Thin Hull Sections up to 5/8 Inches Maximum.

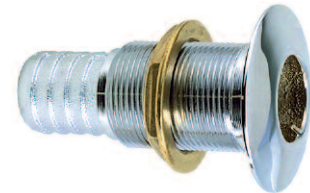

**FIG. 350 CHROME  
REGULAR LENGTH**

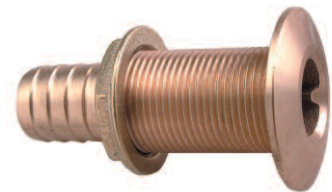

**FIG. 350 PLAIN  
REGULAR LENGTH**



**FIG. 350 CHR  
SHORT LENGTH**



**ILLUSTRATION OF  
BEDDING GROOVE**

**Underwater Hdw, Deck  
Plates, Fills and Vents**



**ORDERING INFORMATION**

**REGULAR LENGTH - PLAIN BRONZE**

Max. Hose Size Inches	Hull Thickness Inches	O.D. Flange Inches	Plain Bronze Dealer Pkg. 5 Pcs.	Plain Bronze OEM Bulk Pkg. 10 Pcs.	Ship Wt. Carton Lbs. DP/OEM Bulk
5/8	1-1/16	1-1/2	350 004 DPP	350 004 PLB	1.6/3.1
3/4	1-5/8	1-7/8	350 005 DPP	350 005 PLB	2.8/5.5
1	1-3/4	2-1/4	350 006 DPP	350 006 PLB	4.1/8.4
1-1/8	1-3/4	2-1/4	350 06A DPP	350 06A PLB	4.9/8.4
1-1/4	1-7/8	2-3/4	350 007 DPP	350 007 PLB	6.7/13.0
1-1/2	1-7/8	3-1/8	350 008 DPP	350 008 PLB	8.3/15.6
2	2	3-3/4	-----	350 009 PLB*	--/2.2

**REGULAR LENGTH - CHROME PLATED BRONZE**

Max. Hose Size Inches	Hull Thickness Inches	O.D. Flange Inches	Chr. Plated Bronze Dealer Pkg. 5 Pcs.	Chr. Plated Bronze OEM Bulk Pkg. 10 Pcs.	Ship Wt. Carton Lbs. DP/OEM Bulk
5/8	1-1/16	1-1/2	350 004 DPC	350 004 CHR	1.9/3.0
3/4	1-5/8	1-7/8	350 005 DPC	350 005 CHR	2.8/5.6
1	1-3/4	2-1/4	350 006 DPC	350 006 CHR	4.6/8.4
1-1/8	1-3/4	2-1/4	350 06A DPC	350 06A CHR	4.4/8.5
1-1/4	1-7/8	2-3/4	350 007 DPC	350 007 CHR	6.5/12.9
1-1/2	1-7/8	3-1/8	350 008 DPC	350 008 CHR	7.9/15.6
2	2	3-3/4	-----	350 009 CHR*	--/2.5

**SHORT LENGTH - PLAIN BRONZE**

Max. Hose Size Inches	Hull Thickness Inches	O.D. Flange Inches	Plain Bronze Dealer Pkg. 5 Pcs.	Plain Bronze OEM Bulk Pkg. 10 Pcs.	Ship Wt. Carton Lbs. DP/OEM Bulk
5/8	5/8	1-1/2	350 S04 DPP	350 S04 PLB	1.5/2.9
3/4	5/8	1-7/8	350 S05 DPP	350 S05 PLB	2.1/3.9
1	5/8	2-1/4	350 S06 DPP	350 S06 PLB	2.7/5.2
1-1/8	5/8	2-1/4	350 S6A DPP	350 S6A PLB	2.9/5.2
1-1/4	5/8	2-3/4	350 S07 DPP	350 S07 PLB	4.2/8.6
1-1/2	5/8	3-1/8	350 S08 DPP	350 S08 PLB	5.8/10.7

**SHORT LENGTH - CHROME PLATED BRONZE**

Max. Hose Size Inches	Hull Thickness Inches	O.D. Flange Inches	Chr. Plated Bronze Dealer Pkg. 5 Pcs.	Chr. Plated Bronze OEM Bulk Pkg. 10 Pcs.	Ship Wt. Carton Lbs. DP/OEM Bulk
5/8	5/8	1-1/2	350 S04 DPC	350 S04 CHR	1.5/2.7
3/4	5/8	1-7/8	350 S05 DPC	350 S05 CHR	2.0/3.9
1	5/8	2-1/4	350 S06 DPC	350 S06 CHR	4.3/5.1
1-1/8	5/8	2-1/4	350 S6A DPC	350 S6A CHR	2.7/5.2
1-1/4	5/8	2-3/4	350 S07 DPC	350 S07 CHR	4.2/8.6
1-1/2	5/8	3-1/8	350 S08 DPC	350 S08 CHR	5.8/11.1

\*OEM Bulk Pkg 1 Pc.

Spare Flanged Nut See Fig. 75, on page 118.



\*\*NOTE: Thru-Hull Connections For Use With Hose Are Not Recommended For Use Below The Waterline Per A.B.Y.C. "Safety Standards For Small Craft" Section H-27.

## THRU-HULL CONNECTIONS



**FIG. 331 - FLUSH MOUNT THRU-HULL CONNECTION FOR USE WITH PIPE**

**CONSTRUCTION:**

**\* CAST BRONZE**

THE EXTERIOR SURFACE OF THE FLANGE IS MACHINED FLAT AND DESIGNED TO BE COUNTERSUNK INTO THE HULL, RESULTING IN A SMOOTH EXTERNAL FIT WITH NO RAISED PORTION TO INCREASE DRAG.



**ORDERING INFORMATION**



**FIG. 331**

Pipe Size Inches	Max. Hull Thickness Inches	O.D. Flange Inches	Dealer Pkg. 5 Pcs	OEM Bulk Package	OEM Bulk Pkg. Qty	Ship Wt. Carton Lbs. DP/OEM Bulk
1/2	2-3/16	1-11/16	331 DP4 PLB	331 004 PLB	10	2.4/4.2
3/4	2-3/8	2	331 DP5 PLB	331 005 PLB	10	2.6/5.2
1	2-9/16	2-1/4	331 DP6 PLB	331 006 PLB	10	3.6/7.2
1-1/4	2-15/16	2-7/8	331 DP7 PLB	331 007 PLB	10	6.3/12.6
1-1/2	3-1/16	2-31/32	331 DP8 PLB	331 008 PLB	10	6.9/13.5
2	3-3/8	3-7/8	-----	331 009 PLB	1	--/2.2

Spare Flanged Nut See Fig. 75, on page 118.



**FIG. 348 - EXTRA LONG THRU-HULL CONNECTION FOR USE WITH PIPE**

**CONSTRUCTION:**

**\* CAST BRONZE**

FLANGE IS MACHINED TO FIT HULL AND GROOVED TO RETAIN BEDDING COMPOUND. NECK IS THREADED TO APPROXIMATELY 3/8 INCH FROM FLANGE.



**ORDERING INFORMATION**



ILLUSTRATION OF BEDDING GROOVE

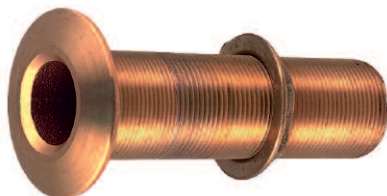

**FIG. 348**

Pipe Size Inches	Max. Hull Thickness Inches	O.D. Flange Inches	Dealer Pkg. 5 Pcs	OEM Bulk Package	OEM Bulk Pkg. Qty	Ship Wt. Carton Lbs. DP/OEM Bulk
3/4	5	1-7/8	348 DP5 PLB	348 005 PLB	25	3.8/18.2
1	4-7/8	2-1/4	348 DP6 PLB	348 006 PLB	10	5.2/10.4
1-1/4	4-5/8	2-3/4	348 DP7 PLB	348 007 PLB	10	9.1/17.2
1-1/2	4-5/8	3	348 DP8 PLB	348 008 PLB	10	10.5/20.9
2	4-1/2	3-5/8	-----	348 009 PLB	1	--/2.8
2-1/2	4-1/4	4-5/16	-----	348 010 PLB	1	--/3.5

Spare Flanged Nut See Fig. 75, on page 118.



**FIG. 322 - THRU-HULL CONNECTION FOR USE WITH PIPE**

**CONSTRUCTION:**

**\* CAST BRONZE**

FLANGE IS MACHINED TO FIT HULL AND GROOVED TO RETAIN BEDDING COMPOUND. NECK IS THREADED TO APPROXIMATELY 3/8 INCH FROM FLANGE.



**ORDERING INFORMATION**



ILLUSTRATION OF BEDDING GROOVE

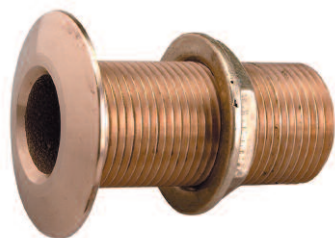

**FIG. 322**

Pipe Size Inches	Max. Hull Thickness Inches	O.D. Flange Inches	Dealer Pkg. 5 Pcs.	Standard Package - 1 Pc.	OEM Bulk Pkg. 25 Pcs.	Ship Wt. Carton Lbs. DP/Std/OEM Bulk
3/8	1-3/4	1-7/16	322 DP3 PLB	-----	322 003 PLB	1.5/--/7.6
1/2	1-3/8	1-1/2	322 DP4 PLB	-----	322 004 PLB	1.7/--/7.9
3/4	1-1/2	1-7/8	322 DP5 PLB	-----	322 005 PLB	2.2/--/10.6
1	1-7/8	2-3/16	322 DP6 PLB	-----	322 006 PLB	3.6/--/17.6
1-1/4	2	2-3/4	322 DP7 PLB	-----	322 007 PLB	5.6/--/27.9
1-1/2	2-1/4	3	322 DP8 PLB	-----	*322 008 PLB	7.6/--/15.0
2	2-3/8	3-5/8	-----	322 009 PLB	*322 009 PLB	--/2.1/--
2-1/2	2-5/8	4-1/2	-----	322 010 PLB	-----	--/2.8/--
3	2-3/4	5	-----	322 011 PLB	-----	--/4.7/--

\* O.E.M. Bulk Pkg. - 10 pcs Spare Flanged Nut See Fig. 75, on page 118.



Underwater Hdwe, Deck Plates, Fills and Vents

## THRU-HULL CONNECTIONS

**FIG. 301 - THRU-HULL CONNECTION FOR USE WITH HOSE\*\***



**CONSTRUCTION:**

- \* **MOLDED WHITE PLASTIC**
- \* **NARROW FLANGE**



**Fig. 301**



**ORDERING INFORMATION**

Hose Size Inches	Max. Hull Thickness Inches	O.D. Flange Inches	Dealer Pkg. 10 Pcs.	OEM Bulk Pkg. 100 Pcs.	Ship Wt. Carton Lbs. DP/OEM Bulk
1/2	1-1/4	1-1/4	301 DP4	301 004	0.6/5.0
5/8	1-1/4	1-1/4	301 DP4A	301 04A	0.6/5.3
3/4	1-7/16	1-1/2	301 DP5	301 005	1.3/7.6
1	1-1/2	1-7/8	301 DP6	301 006***	1.8/6.1
1-1/8	1-1/2	1-7/8	301 DP6A	301 06A***	1.3/6.2
1-1/2	1-7/8	2-1/2	301 DP8	301 008***	3.5/14.5

\*\*\* OEM Bulk Pkg. - 50 pcs.  
Spare Flanged Nut See Fig. 326 on Page 118.



**FIG. 328 - THRU-HULL CONNECTION FOR USE WITH HOSE\*\***



**CONSTRUCTION:**

- \* **MOLDED WHITE PLASTIC**
- \* **BROAD FLANGE**



**Fig. 328**

**ORDERING INFORMATION**

Hose Size Inches	Max. Hull Thickness Inches	O.D. Flange Inches	Dealer Pkg. 10 Pcs.	OEM Bulk Pkg. 100 Pcs.	Ship Wt. Carton Lbs. DP/OEM Bulk
1/2	1-1/4	1-1/2	328 DP4	328 004	0.6/5.9
5/8	1-1/4	1-1/2	328 DP4A	328 04A	0.7/6.0
3/4	1-7/16	1-7/8	328 DP5	328 005	1.0/8.9
1	1-1/2	2-1/4	328 DP6	328 006***	2.0/7.0
1-1/8	1-1/2	2-1/4	328 DP6A	328 06A***	1.5/6.8
1-1/2	1-7/8	3	328 DP8	328 008***	3.4/15.7

\*\*\* OEM Bulk Pkg. - 50 Pcs.  
Spare Flanged Nut See Fig. 326 on Page 118.



**Underwater Hdw, Deck Plates, Fills and Vents**

\*\*NOTE: Thru-Hull Connections For Use With Hose Are Not Recommended For Use Below The Waterline Per A.B.Y.C. "Safety Standards For Small Craft" Section H-27.

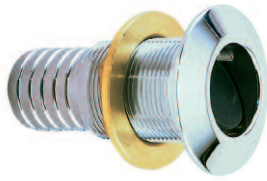

**FIG. 377 - THRU-HULL SCUPPER FOR USE WITH HOSE**

**CONSTRUCTION OPTIONS:**

- \* **CAST BRONZE**
- \* **PLAIN OR CHROME PLATED**
- \* **RECESSED FLAPPER**

**FLANGE IS MACHINED TO FIT HULL AND GROOVED TO RETAIN BEDDING COMPOUND.**



**FIG. 377 A CHR**

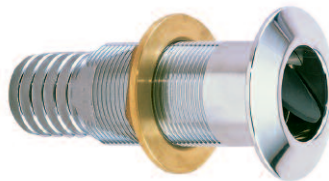

**FIG. 377 B CHR**

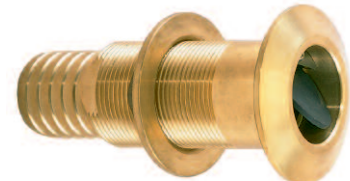

**FIG. 377 B PLB**



**FIG. 377 A PLB**



**ILLUSTRATION OF BEDDING GROOVE**

**ORDERING INFORMATION**

Finish	Hose Size Inches	Maximum Hull Thickness Inches	O.D. Flange Inches	OEM Bulk Pkg. 10 Pcs.	Ship Wt. Carton Lbs. OEM Bulk Pkg.
Chrome	1-1/2	1-3/4	3-1/8	377 A08 CHR	15.5
Plain	1-1/2	1-3/4	3-1/8	377 A08 PLB	15.0
Chrome	2	2	3-3/4	377 A09 CHR	22.6
Chrome	1-1/2	3	3-1/8	377 B08 CHR	20.2
Plain	1-1/2	3	3-1/8	377 B08 PLB	18.2

Spare Flanged Nut See Fig. 75, on page 118.

NOTE: Thru-Hull Connections For Use With Hose Are Not Recommended For Use Below The Waterline Per A.B.Y.C. "Safety Standards For Small Craft" Section H-27.

Underwater Hdwe, Deck Plates, Fills and Vents



**FIG. 361 - FLUSH MOUNT DRAIN FOR USE WITH PIPE**

**CONSTRUCTION:**

- \* **CHROME PLATED CAST BRONZE BODY WITH BRASS SCREEN**

**THE EXTERIOR SURFACE OF THE FLANGE IS MACHINED FLAT AND DESIGNED TO BE COUNTERSUNK INTO THE HULL, RESULTING IN A SMOOTH EXTERNAL FIT.**



**FIG. 361**

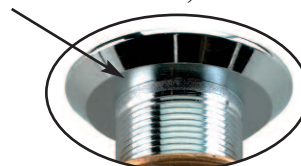

**ORDERING INFORMATION**

Pipe Size Inches	Maximum Thickness Inches	O.D. Flange Inches	Standard Pkg. - 1 Pc.	OEM Bulk Pkg.	Ship Wt. Carton Lbs. Std. Pkg/OEM Bulk
3/4	2-3/8	2	361 005 CHR	10	0.7/6.2
1-1/4	2-15/16	2-7/8	361 007 CHR	10	1.3/12.4

Spare Flanged Nut See Fig. 75, on page 118.

## SCUPPERS

**FIG. 323 - THRU-HULL SCUPPER FOR MOUNTING THROUGH TRANSOM**

**CONSTRUCTION:**

- \* **MOLDED WHITE PLASTIC**
- \* **SOFT BLACK FLAPPER**
- \* **NUT AND MOUNTING HARDWARE INCLUDED**



**ORDERING INFORMATION**

Hose Size Inches	Max. Hull Thickness Inches	O.D. Flange Inches	Dealer Pkg. 5 Cards 1 Pc. per Card	OEM Bulk Pkg. 50 Pcs.	Ship Wt. Carton Lbs. DP/OEM Bulk
1-1/2	2-1/8	2-7/8	323 DP	323	2.5/17.6

Spare Flanged Nut See Fig. 326, on page 118.



**FIG. 323**

**FIG. 327 - THRU-HULL SCUPPER FOR MOUNTING THROUGH TRANSOM**

**CONSTRUCTION:**

- \* **MOLDED WHITE PLASTIC**
- \* **RECESSED SOFT BLACK FLAPPER**
- \* **NUT AND MOUNTING HARDWARE INCLUDED**

**ORDERING INFORMATION**

Hose Size Inches	Max. Hull Thickness Inches	O.D. Flange Inches	OEM Bulk Pkg. 50 Pcs.	Ship Wt. Carton Lbs. OEM Bulk Pkg.
1-1/2	3-1/4	2-7/8	327	19.2

Spare Flanged Nut See Fig. 326, on page 118.



**FIG. 327**

**FIG. 333 - THRU-HULL SCUPPER FOR MOUNTING THROUGH TRANSOM**

**CONSTRUCTION:**

- \* **MOLDED WHITE PLASTIC**
- \* **RECESSED SOFT BLACK FLAPPER**
- \* **NUT AND MOUNTING HARDWARE INCLUDED**



**ORDERING INFORMATION**

Hose Size Inches	Max. Hull Thickness Inches	O.D. Flange Inches	Dealer Pkg. 5 Cards 1 Pc. per Card	OEM Bulk Pkg. 50 Pcs.	Ship Wt. Carton Lbs. DP/OEM Bulk
1-1/2	2-1/8	3	333 DP	333	2.5/15.3

Spare Flanged Nut See Fig. 326, on page 118.

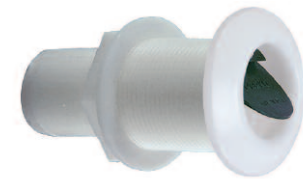

**FIG. 333**

**FIG. 343 - ADJUSTABLE THRU-HULL SCUPPER**

**CONSTRUCTION:**

- \* **MOLDED WHITE PLASTIC**
- \* **RECESSED SOFT BLACK FLAPPER**

Designed for Surface Thickness from 2 inches to 4-3/4 inches.  
Female portion of scupper can be cut down by one rib for each 1/4 inch difference between hull thickness and 4-3/4 inches.



**ORDERING INFORMATION**

I.D. Inches	Max. Hull Thickness Inches	O.D. Flange Inches	Dealer Pkg. 5 Cards 1 Pc. per Card	OEM Bulk Pkg. 50 Pcs.	Ship Wt. Carton Lbs. DP/OEM Bulk
1-11/32	4-3/4	2-15/16	343 DP	343	2.2/13.3



**FIG. 343**



Illustration shows sections of ribs cut out to adjust for surface thickness.

Underwater Hdw., Deck Plates, Fills and Vents

NOTE: The Above Thru-Hull Connections For Use With Hose Are Not Recommended For Use Below The Waterline Per A.B.Y.C. "Safety Standards For Small Craft" Section H-27.

## SCUPPERS

**FIG. 142 - COCKPIT SCUPPER**

**FOR USE WHEN DISCHARGE IS BELOW THE WATERLINE  
CONSTRUCTION:**

- \* **PLAIN OR CHROME PLATED CAST BRONZE**
- \* **RUBBER CHECK BALL**
- \* **DECK KEY INCLUDED**
- \* **ANGLE OF OUTLET IS 45 DEGREES**



**FIG. 142**

**ORDERING INFORMATION**

Hose Size Inches	O.D. Grate Inches	O.D. Flange Inches	Plain Bronze Std. Pkg. - 1 Pc.	Chrome Plated Bronze Std. Pkg. - 1 Pc.	Screw Size	Ship Wt. Carton Lbs. Std. Pkg. PLB/CHR
1	1-13/16	3-1/4	142 001 PLB	142 001 CHR	8	1.5/1.5
1-1/2	2-1/4	3-5/8	142 002 PLB	*142 002 CHR	8	2.4/2.4

\* O.E.M. Bulk Pkg. - 10 pcs.

**SPARE PARTS ORDERING INFORMATION**

Hose Size Inches	Plain Bronze Grate	Chrome Plated Bronze Grate	Check Ball Only	Spare Key Only
1	142 P01 99A	142 C01 99A	142 001 99B	1248 7-8 DP
1-1/2	142 P02 99A	142 C02 99A	142 002 99B	1248 7-8 DP

**FIG. 285 - FLUSH MOUNT COCKPIT SCUPPER FOR USE WITH HOSE**

**FOR USE WHEN DISCHARGE IS ABOVE THE WATERLINE**

**CONSTRUCTION:**

- \* **MOLDED WHITE PLASTIC**

**INSERT PREVENTS PASSAGE OF LARGE OBJECTS WITHOUT RESTRICTING WATER FLOW.**



**FIG. 285**

**ORDERING INFORMATION**

Hose Size Inches	Max. Hull Thickness Inches	O.D. Flange Inches	I.D. Inches	Dealer Pkg. 5 Cards 1 Pc. per Card	OEM Bulk Pkg. 50 Pcs.	Ship Wt. Carton Lbs. DP/OEM Bulk
1-1/2	1-3/4	2-3/4	1-1/2	285 DP	285	2.3/15.7

Spare Flanged Nut See Fig. 326, Below.

**FIG. 365 - SCUPPER VALVE ASSEMBLY FOR SURFACE MOUNT APPLICATIONS**

**CONSTRUCTION:**

- \* **MOLDED WHITE PLASTIC**
- \* **SOFT BLACK FLAPPER**

**THRU-HULL AND MOUNTING HARDWARE NOT INCLUDED.**



**FIG. 365**

**ORDERING INFORMATION**

O.D. Flange Inches	Dealer Pkg. - 5 Cards 1 Pc. per Card	OEM Bulk Pkg. 50 Pcs.	Screw Size	Ship Wt. Carton Lbs. DP/OEM Bulk
2-7/8	365 DP	365	6	0.6/3.2

**FIG. 75 - SPARE FLANGED LOCK NUT**

**CONSTRUCTION: \* CAST BRONZE**

**FIG. 326 - SPARE FLANGED LOCK NUT**

**CONSTRUCTION: \* MOLDED WHITE PLASTIC**



**FIG. 75**



**FIG. 326**

**ORDERING INFORMATION**

Pipe Size Inches	Cast Bronze Nut	Dealer Pkg. Pcs.	Ship Wt. Carton Lbs. Dealer Pkg.	White Plastic Dealer Pkg. - 10 Pcs.	White Plastic OEM Bulk Pkg.	Bulk Pkg. Qty.	Ship Wt. Carton Lbs. DP/OEM Bulk
3/8	75 003 DPP	5	0.3	-----	-----	-----	---
1/2	75 004 DPP	5	0.3	326 DP4	326 004	100	0.4/1.4
3/4	75 005 DPP	5	0.4	326 DP5	326 005	100	0.4/1.5
1	75 006 DPP	5	0.5	326 DP6	326 006	50	0.4/1.0
1-1/4	75 007 DPP	5	0.7	-----	-----	-----	---
1-1/2	75 008 DPP	1	0.3	326 DP8	326 008	50	0.7/1.1
2	75 009 DPP	1	0.4	-----	-----	-----	---
2-1/2	75 010 DPP	1	0.6	-----	-----	-----	---
3	75 011 DPP	1	0.7	-----	-----	-----	---

Underwater Hdwe, Deck Plates, Fills and Vents

## WATER FITTINGS & DECK PLATE

**FIG. 499 - WATER INLET FITTING**  
FOR OBTAINING WATER AT DOCKSIDE

**CONSTRUCTION:**

- \* CHROME PLATED BRONZE
- \* STANDARD FEMALE SWIVEL HOSE CONNECTOR
- \* BLACK PLASTIC WATERTIGHT PLUG
- \* STAINLESS STEEL BEAD CHAIN



**ORDERING INFORMATION**

Pipe Size Inches	O.D. Flange Inches	Dealer Pkg. 5 Cards 1 Pc. per Card	OEM Bulk Pkg. 10 Pcs.	Screw Size	Ship Wt. Carton Lbs. DP/OEM Bulk
1/2	2-3/4	499 DP CHR	499 000 CHR	8	2.6/4.6

Spare Plug with Chain, Cat. No. 499 DP 99A.

**IMPROVED  
PRODUCT**



**FIG. 499**

**FIG. 504 - WATER OUTLET FITTING**  
FOR USE WITH ON-BOARD WASHDOWN SYSTEMS

**CONSTRUCTION:**

- \* CHROME PLATED BRONZE
- \* STANDARD MALE HOSE CONNECTOR
- \* WATERTIGHT BLACK PLASTIC CAP
- \* STAINLESS STEEL BEAD CHAIN



**ORDERING INFORMATION**

Pipe Size Inches	O.D. Flange Inches	Dealer Pkg. 5 Cards 1 Pc. per Card	OEM Bulk Pkg. 10 Pcs.	Screw Size	Ship Wt. Carton Lbs. DP/OEM Bulk
1/2	2-3/4	504 DP CHR	504 000 CHR	8	2.4/4.1

Spare Cap with Chain, Cat. No. 504 DP 99A.



**FIG. 504**

**FIG. 526 - REGULAR DECK PLATE**

**CONSTRUCTION OPTIONS:**

- \* CAST BRONZE
- \* PLAIN OR CHROME PLATED
- \* DECK KEY INCLUDED

**ORDERING INFORMATION**

I.D. Opening Inches	O.D. Overall Inches	Plain Bronze Standard Pkg. - 1 Pc.	Chrome Plated Bronze Standard Pkg. - 1 Pc.	Screw Size	Ship Wt. Carton Lbs. Std. Pkg. PLB/CHR
3	5-3/8	526 003 PLB	526 003 CHR	10	2.2/2.2
4	7-1/16	526 004 PLB	526 004 CHR	10	3.3/3.3
5	8-3/8	526 005 PLB	526 005 CHR	10	5.1/5.2
6	9-3/8	526 006 PLB	526 006 CHR	1/4	7.9/7.9

**SPARE PARTS ORDERING INFORMATION**

I.D. Opening Inches	Plain Bronze Cap	Chrome Plated Bronze Cap	Spare Key Only
3	526 P03 99A	526 C03 99A	1248 010 ZNC
4	526 P04 99A	526 C04 99A	539 004 PLB
5	526 P05 99A	526 C05 99A	539 005 PLB
6	526 P06 99A	526 C06 99A	539 006 PLB

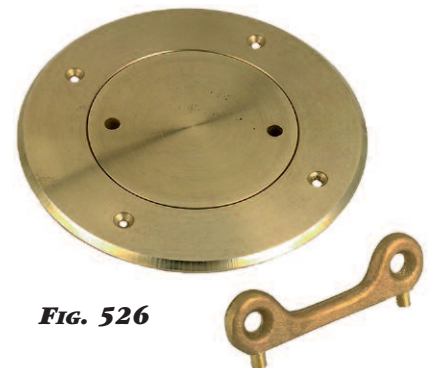

**FIG. 526**

Underwater Hdw, Deck  
Plates, Fills and Vents

## COMBINATION FILLS & TANK VENTS

### Figs. 540, 541, 542 & 543 - COMBINATION FILLS & TANK VENTS

PATENT NOS. 5,275,213 & 5,327,946

#### CONSTRUCTION:

**INTEGRAL TANK VENT WITH FLAME ARRESTOR AND ANTI SURGE VALVE  
DECK PLATE KEY INCLUDED**



Fig. 540

**\* 540/541 CHROME PLATED BRONZE CAP WITH BLACK PLASTIC BASE**  
**FIG. 540 - ANGLED NECK & HEAVY DUTY STAINLESS STEEL BEAD CHAIN**  
**FIG. 541 - STRAIGHT NECK & HEAVY DUTY STAINLESS STEEL BEAD CHAIN**  
**GROUND WIRE REQUIRED FOR FIGS 540 AND 541 ONLY**

**\* 542/543 BLACK OR WHITE PLASTIC CAP WITH BLACK PLASTIC BASE**  
**FIG. 542 - ANGLED NECK & BLACK PLASTIC STRAP**  
**FIG. 543 - STRAIGHT NECK & BLACK PLASTIC STRAP**



#### ORDERING INFORMATION

Marked For:	Cap Type	For Fuel Hose Inches	For Vent Hose Inches	Length Neck Inches	Dealer Pkg 5 Pcs.	OEM Bulk Pkg. 25 Pcs.	Screw Size	Ship Wt. Carton Lbs. DP/OEM Bulk
<b>CHROME CAP &amp; ANGLED NECK</b>								
Gas	Chrome	1-1/2	5/8	2-7/16	540 DPG CHR*	540 G00 CHR*	8	3.6/15.1
Diesel	Chrome	1-1/2	5/8	2-7/16	540 DPD CHR	540 D00 CHR	8	4.0/15.1
Water	Chrome	1-1/2	5/8	2-7/16	540 DPW CHR	540 W00 CHR	8	3.8/14.7
<b>CHROME CAP &amp; STRAIGHT NECK</b>								
Gas	Chrome	1-1/2	5/8	2-7/16	541 DPG CHR*	541 G00 CHR*	8	3.6/14.7
Diesel	Chrome	1-1/2	5/8	2-7/16	541 DPD CHR	541 D00 CHR	8	3.5/14.2
Water	Chrome	1-1/2	5/8	2-7/16	541 DPW CHR	541 W00 CHR	8	3.6/14.7
<b>BLACK OR WHITE PLASTIC CAP &amp; ANGLED NECK</b>								
Gas	Black	1-1/2	5/8	2-7/16	542 DPG BLK*	542 G00 BLK*	8	2.5/9.4
Gas	White	1-1/2	5/8	2-7/16	542 DPG WHT*	542 G00 WHT*	8	2.5/9.5
Water	Black	1-1/2	5/8	2-7/16	542 DPW BLK	542 W00 BLK	8	2.7/9.4
<b>BLACK OR WHITE PLASTIC CAP &amp; STRAIGHT NECK</b>								
Gas	Black	1-1/2	5/8	2-7/16	543 DPG BLK*	543 G00 BLK*	8	2.5/9.4
Gas	White	1-1/2	5/8	2-7/16	543 DPG WHT*	543 G00 WHT*	8	2.7/9.5
Water	Black	1-1/2	5/8	2-7/16	543 DPW BLK	543 W00 BLK	8	2.5/9.4



Fig. 541



Fig. 542



Fig. 543

FOR A MATCHING WASTE DECK PLATE PLEASE SEE FIG. 556 ON PAGE 126.

Note: Consider the use of the Mounting Ring (Fig. 540 DPR BLK) on page 121 for all installations.



Spare Deck Plate Key Cat. No. 1247 DP BLK.

\*NOTE: These Items Meet the Requirements of U.S.C.G. Safety Standards, January 31, 1977, for Gasoline Fuel Systems, 33CFR183.

Underwater Hdwe, Deck Plates, Fills and Vents



## COMBINATION FILLS & TANK VENTS

**FIG. 577 - COMBINATION GAS FILL & TANK VENT FOR 2 INCH HOSE**

PATENT NO. 5,275,213

**CONSTRUCTION:**

- \* CHROME PLATED BRONZE
- \* INTEGRAL TANK VENT WITH FLAME ARRESTOR
- \* FIG. NO. 1247 DECK PLATE KEY, O-RING AND INTEGRAL RETAINER ON CAP INCLUDED
- \* GROUND WIRE REQUIRED



**FIG. 577**

**ORDERING INFORMATION**

Marked For:	For Fuel Hose Inches	For Vent Hose Inches	Length Neck Inches	OEM Bulk Pkg. 10 Pcs. Std. Pkg. - 1 Pc.	Screw Size	Ship Wt. Carton Lbs. Std Pkg/OEM Bulk
Gas	2	5/8	3-5/8	577 G00 CHR*	8	1.8/19.5
Diesel	2	5/8	3-5/8	577 D00 CHR	8	1.8/19.5

**FIGS. 1318 & 1319 - COMBINATION FILL & TANK VENT**

PATENT NO. 5,275,213

**CONSTRUCTION OPTIONS:**

- \* BLACK OR WHITE PLASTIC
  - \* INTEGRAL TANK VENT WITH FLAME ARRESTOR
  - \* NO DECK PLATE KEY OR GROUND WIRE REQUIRED
  - \* FLIP TOP CAP
- FIG. 1318 - 35° ANGLED NECK**



**FIG. 1318**



**FIG. 1319**



**ORDERING INFORMATION**

Marked For:	For Fuel Hose Inches	For Vent Hose Inches	Length Neck Inches	Dealer Pkg. 10 Cards 1 Pc. per Card	OEM Bulk Pkg. 50 Pcs.	Screw Size	Ship Wt. Carton Lbs. DP/OEM Bulk
Gas	1-1/2	5/8	2-7/16	1318 DPG BLK*	1318 G00 BLK*	10	4.7/18.3
Gas	1-1/2	5/8	2-7/16	1319 DPG BLK*	1319 G00 BLK*	10	4.3/14.5
Gas	1-1/2	5/8	2-7/16	1319 DPG WHT*	1319 G00 WHT*	10	4.3/14.5
Water	1-1/2	5/8	2-7/16	1319 DPW BLK	1319 W00 BLK	10	4.3/15.1
Water	1-1/2	5/8	2-7/16	1319 DPW WHT	1319 W00 WHT	10	4.3/14.4

**FIG. 540 RING- SPARE MOUNTING RING**

**INSTALLATION NOTE**

**ON THE USE OF VENTED FUEL FILLS**

**PERKO FIGURE NOS. 540, 541, 542 & 543**

The use of these heightening rings is required in any application where water might be splashed around a vented fill. The ring raises the opening between the fuel cap and fill an additional 3/8" above the deck surface thereby reducing the likelihood that splashed water will enter the fuel system through the breathing vent. The split version of the ring is designed for aftermarket use on existing installations. In most cases it allows the ring to be added without disconnecting fuel and vent hoses from the fill. For new OEM installations, rings are supplied without the split since they can then be installed before hoses are connected to the fill.

NOTE: The ring will not prevent water from entering the system if the cap becomes submerged or substantially flooded. If this situation exists, the fill/vent must be moved to a dry location or replaced with a sealed cap and a separate vent located elsewhere.



**FIG. 540 DPR**

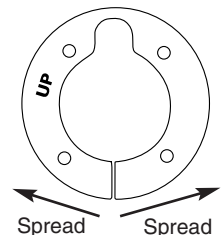

**ORDERING INFORMATION**

Dealer Pkg. - 5 Cards 1 Pc Per Card	OEM Bulk Pkg. 50 Pcs.
540 DPR BLK	540 RNG BLK

\*NOTE: These Items Meet the Requirements of U.S.C.G. Safety Standards, January 31, 1977, for Gasoline Fuel Systems, 33CFR183.

Underwater Hdwe, Deck Plates, Fills and Vents

## FUEL & WATER DECK PLATES

**FIG. 576 - DECK PLATE FOR 2 INCH HOSE**

**CONSTRUCTION:**

\* **CHROME PLATED BRONZE**

\* **FIG. NO. 1247 DECK PLATE KEY, O-RING AND INTEGRAL RETAINER ON CAP INCLUDED**



**Fig. 576**

**ORDERING INFORMATION**

Marked For:	Hose Size Inches	O.D. Flange Inches	Length Neck Inches	OEM Bulk Pkg. 25 Pcs. Std. Pkg. 1 Pc.	Screw Size	Ship Wt. Carton Lbs. Std Pkg/OEM Bulk
Gas	2	3-3/8	3-5/8	576 G00 CHR*	8	1.2/12.0
Diesel	2	3-3/8	3-5/8	576 D00 CHR	8	1.1/12.0

Spare Gas Cap with O-Ring and Retainer, Cat. No. 576 DPG 99A  
 Spare Diesel Cap with O-Ring and Retainer, Cat. No. 576 DPD 99A  
 Spare Retaining Ring, Cat. No. 537 DP2.  
 Spare Key, Cat. No. 1247 DP BLK.

**FIG. 557 - DECK PLATE FOR HOSE**

**CONSTRUCTION:**

\* **CHROME PLATED BRONZE**

\* **BLACK PLASTIC BODY**

\* **FIG. NO. 1247 DECK PLATE KEY AND O-RING INCLUDED**



**Fig. 557**

**ORDERING INFORMATION**

Marked For:	Hose Size Inches	O.D. Flange Inches	Length Neck Inches	Dealer Pkg. 5 Cards 1 Pc. per Card	OEM Bulk Pkg. 25 Pcs.	Screw Size	Ship Wt. Carton Lbs. DP/OEM Bulk
Gas	1-1/2	3-3/8	3-1/8	557 DPG CHR*	557 G00 CHR*	8	3.7/14.0
Diesel	1-1/2	3-3/8	3-1/8	557 DPD CHR	557 D00 CHR	8	3.7/14.0
Water	1-1/2	3-3/8	3-1/8	557 DPW CHR	557 W00 CHR	8	3.7/14.0

Gas Spare Cap with O-Ring, Cat. No. 557 DPG 99A. Spare Key, Cat. No. 1247 DP BLK.  
 Diesel Spare Cap with O-Ring, Cat. No. 557 DPD 99A.  
 Water Spare Cap with O-Ring, Cat. No. 557 DPW 99A.

**FOR MATCHING WASTE DECK PLATES SEE FIG. 556 ON PAGE 126.**

**FIG. 520 - DECK PLATES FOR 1-1/2 INCH HOSE**

**CONSTRUCTION:**

\* **FIG. 520 - CHROME PLATED BRONZE**

\* **FIG. NO. 1248 DECK PLATE KEY, O-RING AND INTEGRAL RETAINER ON CAP INCLUDED**

\* **CAPS HAVE A SLOT BETWEEN THE HOLES**



**Fig. 520**

**ORDERING INFORMATION**

Marked For:	Hose Size Inches	O.D. Flange Inches	Length Neck Inches	Dealer Pkg. 5 Cards 1 Pc. per Card	OEM Bulk Pkg. 25 Pcs.	Screw Size	Ship Wt. Carton Lbs. DP/OEM Bulk
Gas	1-1/2	3-1/8	3-1/2	520 DPG CHR*	520 G00 CHR*	8	3.9/18.3
Diesel	1-1/2	3-1/8	3-1/2	520 DPD CHR	520 D00 CHR	8	3.9/18.9
Water	1-1/2	3-1/8	3-1/2	520 DPW CHR	520 W00 CHR	8	4.0/18.1

Spare Cap with O-Ring and Retainer, Cat. No. 520 DP 99A. Spare Key, Cat. No. 1248 7-8 DP.

**FOR MATCHING WASTE DECK PLATES SEE FIG. 507 ON PAGE 127.**

\*NOTE: These Items Meet the Requirements of U.S.C.G. Safety Standards, January 31, 1977, for Gasoline Fuel Systems, 33CFR183.

Underwater Hdwe, Deck Plates, Fills and Vents

## DECK PLATES

**FIG. 528 - DECK PLATES FOR PIPE**

**CONSTRUCTION OPTIONS:**

- \* **CAST BRONZE**
- \* **PLAIN OR CHROME PLATED**
- \* **1-1/4 AND 1-1/2 INCH CAPS HAVE A SLOT BETWEEN THE HOLES**
- \* **FIG. NO. 1248 DECK PLATE KEY AND O-RING INCLUDED**



**ORDERING INFORMATION**

**FOR UNMARKED DECK PLATES**

Pipe Size Inches	O.D. Flange Inches	Plain Bronze Std. Pkg. - 1 Pc.	Chrome Plated Bronze Std. Pkg. - 1 Pc.	Chrome Plated Bronze OEM Bulk Pkg. 10 Pcs.	Ship Wt. Carton Lbs. PLB/CHR/OEM Bulk
1	2-7/8	528 006 PLB	528 006 CHR	-----	0.6/0.7/--
1-1/4	3-5/16	528 007 PLB	528 007 CHR	-----	0.7/0.7/--
1-1/2	3-5/8	528 008 PLB	528 DP8 CHR*	528 008 CHR	1.0/4.7/8.9
2	4-1/4	528 009 PLB	528 009 CHR	-----	2.0/2.1/--
2-1/2	4-5/8	528 010 PLB	528 010 CHR	-----	2.0/2.0/--
3	5-3/8	528 011 PLB	528 011 CHR	-----	3.0/3.1/--

**\*\*FOR GAS DECK PLATES**

Pipe Size Inches	O.D. Flange Inches	Plain Bronze Std. Pkg. - 1 Pc.	Chrome Plated Bronze Std. Pkg. - 1 Pc.	Chrome Plated Bronze OEM Bulk Pkg. 10 Pcs.	Ship Wt. Carton Lbs. PLB/CHR/OEM Bulk
1-1/2	3-5/8	528 G08 PLB	528 DPG CHR*	528 G08 CHR	1.0/5.0/8.9
2	4-1/4	-----	528 G09 CHR	528 G09 CHR	--/2.0/3.2

**FOR DIESEL DECK PLATES**

Pipe Size Inches	O.D. Flange Inches	Plain Bronze Std. Pkg. - 1 Pc.	Chrome Plated Bronze Std. Pkg. - 1 Pc.	Chrome Plated Bronze OEM Bulk Pkg. 10 Pcs.	Ship Wt. Carton Lbs. PLB/CHR/OEM Bulk
1-1/2	3-5/8	528 D08 PLB	528 DPD CHR*	528 D08 CHR	1.0/5.1/8.9
2	4-1/4	528 D09 PLB	528 D09 CHR	-----	2.0/2.0/--

**FOR WATER DECK PLATES**

Pipe Size Inches	O.D. Flange Inches	Plain Bronze Std. Pkg. - 1 Pc.	Chrome Plated Bronze Std. Pkg. - 1 Pc.	Chrome Plated Bronze OEM Bulk Pkg. 10 Pcs.	Ship Wt. Carton Lbs. PLB/CHR/OEM Bulk
1-1/2	3-5/8	528 W08 PLB	528 DPW CHR*	528 W08 CHR	1.0/5.0/8.8

Screw Sizes: 2-1/2 and 3 Inch Deck Plates #10, All Others #8.

\*\*Note: These Deck Plates Meet the Requirements of U.S.C.G. Safety Standards, January 31, 1977, for Gasoline Fuel Systems, 33CFR183.

\* Dealer Package 5 Pcs., 1 Pc. per Card

**FOR MATCHING WASTE DECK PLATE SEE FIG. 524 ON PAGE 126**



**FIG. 528**



**FIG. 528 GAS**



**FIG. 528 DIESEL**



**FIG. 528 WATER**

**Underwater Hdw, Deck Plates, Fills and Vents**

**SPARE PARTS ORDERING INFORMATION**

Pipe Size Inches	Plain Bronze Cap*	Chrome Plated Bronze Cap*	O-Rings Only (2 per bag, 5 bags/Pkg)	Spare Key
1	528 P06 99A	528 C06 99A	513 006	1248 006 DP***
1-1/4	528 P07 99A	528 C07 99A	513 007	1248 7-8 DP***
1-1/2	528 P08 99A	528 DP8 99A**	513 DP8	1248 7-8 DP***
2	528 P09 99A	528 C09 99A	513 009	1248 009 DP***
2-1/2	528 P10 99A	528 C10 99A	513 010	1248 010 ZNC
3	528 P11 99A	528 C11 99A	513 011	528 011 99C

\* Complete With O-Ring.

\*\* Dealer Pkg. - 5 pcs. (1 pc. per card).

\*\*\* Dealer Pkg. - 10 pcs. (1 pc. per card).

**FIG. 527 - DECK PLATES FOR HOSE**



**FIG. 527**

**CONSTRUCTION:**

- \* **CHROME PLATED BRONZE**
- \* **35° ANGLED HOSE BIBS**
- \* **FIG. NO. 1247 KEY, O-RING AND FIG. NO. 537 RETAINING CABLE ON CAP INCLUDED**
- \* **CAPS HAVE A SLOT BETWEEN THE HOLES**

**ORDERING INFORMATION**

Marked For:	Hose Size Inches	O.D. Flange Inches	Length Neck Inches	Standard Pkg. - 1 Pc.	Screw Size	Ship Wt. Carton Lbs. Std. Pkg.
Gas	1-1/2	3-1/2	4-7/8	527 G08 CHR*	10	2.6

Spare Cap with O-Ring, Cat. No. 528 DP8 99A. Spare O-Rings Only (2 per bag), Cat. No. 513 DP8. Spare Key, Cat. No. 1248 7-8 DP.

Underwater Hdwe, Deck Plates, Fills and Vents

**FIG. 1270 - DECK PLATE FOR HOSE**



**FIG. 1270**

**CONSTRUCTION:**

- \* **CHROME PLATED ZINC ALLOY**
- \* **BLACK PLASTIC CAP**
- \* **FIG. NO. 1248 DECK PLATE KEY, O-RING AND INTEGRAL RETAINER ON CAP INCLUDED**
- \* **CAPS HAVE A SLOT BETWEEN THE HOLES**

**ORDERING INFORMATION**

Marked For:	Hose Size Inches	O.D. Flange Inches	Length Neck Inches	Dealer Pkg. 5 Cards 1 Pc. per Card	OEM Bulk Pkg. 25 Pcs.	Screw Size	Ship. Wt. Carton Lbs. DP/OEM Bulk
Gas	1-1/2	3-1/2	2-1/2	1270 DPG CHR*	1270 G00 CHR*	8	3.9/17.4
Diesel	1-1/2	3-1/2	2-1/2	1270 DPD CHR	1270 D00 CHR	8	4.0/17.4
Water	1-1/2	3-1/2	2-1/2	1270 DPW CHR	1270 W00 CHR	8	4.1/17.3

Spare Gas Cap with O-Ring and Retainer, Cat. No. 1270 DPG 99A.  
 Spare Diesel Cap with O-Ring and Retainer, Cat. No. 1270 DPD 99A.  
 Spare Water Cap with O-Ring and Retainer, Cat. No. 1270 DPW 99A.  
 Spare O-Rings Only (2 per bag), Cat. No. 513 DP8.  
 Spare Key, Cat. No. 1248 7-8 DP.



\*NOTE: These Items Meet the Requirements of U.S.C.G. Safety Standards, January 31, 1977, for Gasoline Fuel Systems, 33CFR183.

## GAS FILLS

### Figs. 1313 & 1399 - Gas Fills

PATENT No. 3,828,714

#### CONSTRUCTION:

- \* CHROME PLATED ZINC ALLOY
- \* BLACK PLASTIC FLANGE
- \* BLACK PLASTIC CAP WITH STRAP
- \* GROUNDING SCREW INCLUDED
- \* CAP RETAINER AND GASKET
- \* LOCKING CAP HAS A COVER FOR THE KEY HOLE



Fig. 1313

**IMPROVED  
PRODUCT**



Fig. 1399



#### ORDERING INFORMATION

Marked For:	Hose Size Inches	O.D. Flange Inches	Length Neck Inches	Dealer Pkg. 5 Cards 1 Pc. per Card	OEM Bulk Pkg. 50 Pcs.	Ship Wt. Carton Lbs. DP/OEM Bulk
*Gas	1-1/2	3-1/8	1-7/8	1313 DP CHR	1313 000 CHR	2.9/24.4
*Gas w/Lock	1-1/2	3-1/8	1-7/8	1399 DP CHR	1399 000 CHR	3.1/25.6

Screw Size #6.

Spare Non-Locking Cap, Cat. No. 126 DP BLK.

Spare Locking Cap with 2 keys, Cat. No. 1324 DP BLK.

### FIG. 1613 - PLASTIC GAS FILL

#### CONSTRUCTION:

- \* FIBER REINFORCED, U.V. STABILIZED BLACK PLASTIC
- \* NO DECK PLATE KEY OR GROUND WIRE REQUIRED
- \* EASY-GRIP CAP
- \* O-RING AND CAP RETAINER INCLUDED



#### ORDERING INFORMATION

For Hose Inches	O.D. Overall Inches	Length Neck Inches	Dealer Pkg. 5 Cards 1 Pc. per Card	OEM Bulk Pkg. 50 Pcs.	Screw Size	Ship Wt. Carton Lbs. DP/OEM Bulk
1-1/2	3-1/16	2-7/16	1613 DP BLK*	1613 000 BLK*	8	2.0/14.4

Spare Cap with O-Ring and Retainer, Cat. No. 1613 000 99A.

Spare O-Rings (2 per bag), Cat. No. 513 DP8.



Fig. 1613

Underwater Hdwe, Deck Plates, Fills and Vents

### FIG. 1413 - GAS FILL

#### CONSTRUCTION:

- \* CHROME PLATED ZINC ALLOY
- \* BLACK PLASTIC CAP AND BASE
- \* INTEGRAL CAP RETAINER/GASKET INCLUDED



#### ORDERING INFORMATION

For Hose Inches	Length Neck Inches	Dimensions Overall Inches	Standard Pkg. 1 Pc.	Screw Size	Ship Wt. Carton Lbs. DP/OEM Bulk
1-1/2	1-7/8	3 x 3	1413 000 CHR*	6	0.6

Spare Cap, Cat. No. 126 DP BLK.



Fig. 1413

\*NOTE: These Items Meet the Requirements of U.S.C.G. Safety Standards, January 31, 1977, for Gasoline Fuel Systems, 33CFR183.

## WASTE DECK PLATES

**FIG. 556 - WASTE DECK PLATE FOR HOSE**

**CONSTRUCTION:**

\* **CHROME PLATED BRONZE**

\* **BLACK PLASTIC BODY**

\* **FIG. No. 1247 DECK PLATE KEY AND O-RING INCLUDED**



**FIG. 556**



**ORDERING INFORMATION**

Hose Size Inches	O.D. Flange Inches	Length Neck Inches	Dealer Pkg. 5 Cards 1 Pc. per Card	OEM Bulk Pkg. 25 Pcs.	Screw Size	Ship Wt. Carton Lbs. DP/OEM Bulk
1-1/2	3-3/8	3-1/8	556 DP CHR	556 000 CHR	8	3.7/14.0

Spare Cap with O-Ring, Cat. No. 556 DP 99A  
Spare Key, Cat. No. 1247 DP BLK.

**FIG. 524 - WASTE DECK PLATE FOR PIPE**

**CONSTRUCTION:**

\* **CHROME PLATED BRONZE**

\* **FIG. No. 1248 DECK PLATE KEY AND O-RING INCLUDED**

\* **CAP HAS A SLOT BETWEEN THE HOLES**



**FIG. 524**



**ORDERING INFORMATION**

Pipe Size Inches	O.D. Flange Inches	Dealer Pkg. 5 Cards 1 Pc. per Card	OEM Bulk Pkg. 10 Pcs.	Screw Size	Ship Wt. Carton Lbs. DP/OEM Bulk
1-1/2	3-5/8	524 DP CHR	524 000 CHR	8	4.8/8.6

Spare Cap with O-Ring, Cat. No. 524 DP 99A.  
Spare O-Rings Only (2 per bag), Cat. No. 513 DP8.  
Spare Key, Cat. No. 1248 7-8 DP.

Underwater Hdwe, Deck Plates, Fills and Vents

NOTE: These Items Comply with Adopted Standards on "Fittings" A.B.Y.C. Recommended Practices Standards Covering Sewage Holding and/or Treatment Devices for Marine Waste Systems.

## WASTE DECK PLATES

**FIG. 507 - WASTE DECK PLATES FOR HOSE**

**CONSTRUCTION:**

- \* **CHROME PLATED BRONZE**
- \* **FIG. No. 1248 DECK PLATE KEY AND O-RING INCLUDED**
- \* **CAP HAS A SLOT BETWEEN THE HOLES**



**FIG. 507**



**ORDERING INFORMATION**

Hose Size Inches	O.D. Flange Inches	Length Neck Inches	Dealer Pkg. 5 Cards 1 Pc. per Card	OEM Bulk Pkg. 25 Pcs.	Screw Size	Ship Wt. Carton Lbs. DP/OEM Bulk
1-1/2	3-1/8	3-1/2	507 DP CHR	507 000 CHR	8	3.8/18.4

Spare Cap with O-Ring, Cat. No. 507 DP 99A.  
 Spare O-Rings Only (2 per bag), Cat. No. 513 DP8.  
 Spare Key, Cat. No. 1248 7-8 DP.

**FIG. 1269 - WASTE DECK PLATE FOR HOSE**

**CONSTRUCTION:**

- \* **CHROME PLATED ZINC ALLOY**
- \* **BLACK PLASTIC CAP**
- \* **FIG. No. 1248 DECK PLATE KEY AND O-RING INCLUDED**
- \* **CAP HAS A SLOT BETWEEN THE HOLES**



**FIG. 1269**



**ORDERING INFORMATION**

Hose Size Inches	O.D. Flange Inches	Length Neck Inches	Dealer Pkg. 5 Cards 1 Pc. per Card	OEM Bulk Pkg. 25 Pcs.	Screw Size	Ship Wt. Carton Lbs. DP/OEM Bulk
1-1/2	3-1/2	2-1/2	1269 DP CHR	1269 000 CHR	8	3.9/17.0

Spare Cap with O-Ring, Cat. No. 1269 DP 99A.  
 Spare O-Rings Only (2 per bag), Cat. No. 513 DP8.  
 Spare Key, Cat. No. 1248 7-8 DP.

**Underwater Hdw, Deck Plates, Fills and Vents**

NOTE: These Items Comply with Adopted Standards on "Fittings" A.B.Y.C. Recommended Practices Standards Covering Sewage Holding and/or Treatment Devices for Marine Waste Systems.

## GAS TANK VENTS

**FIG. 570 - GAS TANK VENT**

**CONSTRUCTION:**

- \* CHROME PLATED ZINC ALLOY COWL
- \* BLACK OR WHITE PLASTIC CAP
- \* REMOVABLE 30 MESH STAINLESS STEEL WIRE SCREEN FLAME ARRESTER

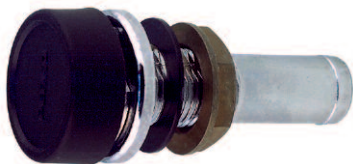

**FIG. 570**



**ORDERING INFORMATION**

	Hose Size Inches	Max. Hull Thickness Inches	Dealer Pkg. 10 Cards 1 Pc. per Card	OEM Bulk Pkg. 50 Pcs.	Ship Wt. Carton Lbs. DP/OEM Bulk
Color					
Black	5/8	3/4	570 DP4 BLK	570 004 BLK	2.4/9.6
White	5/8	3/4	570 DP4 WHT	570 004 WHT	2.3/9.7

**FIG. 571 - GAS TANK VENT WITH SWIVEL ELBOW**

**CONSTRUCTION:**

- \* BLACK OR WHITE PLASTIC CAP WITH ZINC ALLOY ELBOW
- \* REMOVABLE 30 MESH STAINLESS STEEL WIRE SCREEN FLAME ARRESTER

**IMPROVED PRODUCT**



**FIG. 571**



DESIGN ALLOWS ELBOW TO BE ROTATED TO ANY POSITION

**ORDERING INFORMATION**

	Hose Size Inches	Max. Hull Thickness Inches	Dealer Pkg. 10 Cards 1 Pc. per Card	OEM Bulk Pkg. 50 Pcs.	Ship Wt. Carton Lbs. DP/OEM Bulk
Color					
Black	5/8	3/4	571 DP4 BLK	571 004 BLK	2.5/9.5
White	5/8	3/4	571 DP4 WHT	571 004 WHT	2.5/9.5

**FIG. 561 - GAS TANK VENT WITH SWIVEL ELBOW**

**CONSTRUCTION:**

- \* CHROME PLATED ZINC ALLOY CAP WITH ZINC ALLOY ELBOW
- \* BLACK PLASTIC SPLASH GUARD
- \* REMOVABLE 30 MESH STAINLESS STEEL WIRE SCREEN FLAME ARRESTER



**FIG. 561**



DESIGN ALLOWS ELBOW TO BE ROTATED TO ANY POSITION

**ORDERING INFORMATION**

	Hose Size Inches	Max. Hull Thickness Inches	Dealer Pkg. 10 Cards 1 Pc. per Card	OEM Bulk Pkg. 50 Pcs.	Ship Wt. Carton Lbs. DP/OEM Bulk
	5/8	1	561 DP4 CHR	561 004 CHR	2.8/11.4

Spare Splash Guard Cat. No. 518 000 BLK

**FIG. 506 - GAS TANK VENT**

**CONSTRUCTION:**

- \* CHROME PLATED ZINC ALLOY WITH BLACK PLASTIC SPLASH GUARD
- \* REMOVABLE 30 MESH STAINLESS STEEL WIRE SCREEN FLAME ARRESTER



**FIG. 506**



**ORDERING INFORMATION**

	Hose Size Inches	Max. Hull Thickness Inches	Dealer Pkg. 10 Cards 1 Pc. per Card	OEM Bulk Pkg. 50 Pcs.	Ship Wt. Carton Lbs. DP/OEM Bulk
	5/8	3/4	506 DP4 CHR	506 004 CHR	2.1/8.0

Spare Splash Guard Cat. No. 518 000 BLK

**Note: All of the Above Vents are Designed to Meet the Requirements of U.S.C.G. Safety Standards January 31, 1977, for Gasoline Fuel Systems 33CFR183.**

Underwater Hdwe, Deck Plates, Fills and Vents



## GAS TANK VENTS

**FIG. 509 - GAS TANK VENT**

**CONSTRUCTION:**

- \* CHROME PLATED BRONZE
- \* REMOVABLE 30 MESH STAINLESS STEEL WIRE SCREEN FLAME ARRESTER



**ORDERING INFORMATION**

Hose Size Inches	Max. Hull Thickness Inches	Dealer Pkg. 10 Cards 1 Pc. per Card	OEM Bulk Pkg. 50 Pcs.	Ship Wt. Carton Lbs. DP/OEM Bulk
5/8	3/4	509 DP4 CHR	509 004 CHR	1.5/11.8
3/4	5/8	509 DP5 CHR	509 005 CHR	1.7/13.2



**FIG. 509**

**FIG. 503 - GAS TANK VENT**

**CONSTRUCTION:**

- \* CHROME PLATED BRONZE
- \* REMOVABLE 30 MESH STAINLESS STEEL WIRE SCREEN FLAME ARRESTER



**ORDERING INFORMATION**

Thread Size Inches	Max. Hull Thickness Inches	Dealer Pkg. 5 Cards 1 Pc. per Card	OEM Bulk Pkg. 50 Pcs.	Ship Wt. Carton Lbs. DP/OEM Bulk
3/8	7/8	503 DP3 CHR	503 003 CHR	1.9/16.3
1/2	7/8	503 DP4 CHR	503 004 CHR	1.9/16.0



**FIG. 503**

**FIG. 515 - GAS TANK VENT**

**CONSTRUCTION:**

- \* CHROME PLATED BRONZE
- \* REMOVABLE 30 MESH STAINLESS STEEL WIRE SCREEN FLAME ARRESTER



**ORDERING INFORMATION**

Thread Size Inches	Max. Hull Thickness Inches	Dealer Pkg. 5 Cards 1 Pc. per Card	OEM Bulk Pkg. 50 Pcs.	Ship Wt. Carton Lbs. DP/OEM Bulk
3/8	5/8	515 DP3 CHR	515 003 CHR	1.2/8.9
1/2	5/8	515 DP4 CHR	515 004 CHR	1.4/10.4



**FIG. 515**

Underwater Hdwe, Deck Plates, Fills and Vents

**FIG. 505 - GAS TANK VENT**

**CONSTRUCTION:**

- \* CHROME PLATED CAST BRONZE
- \* REMOVABLE 30 MESH STAINLESS STEEL WIRE SCREEN FLAME ARRESTER

Designed to meet the requirements of the National Fire Protection Association Booklet No. 302, Section No. 323 on vent pipe outlets. The 1/2 inch N.P.T. is off center to create a water baffle.



**ORDERING INFORMATION**

O.D. Flange Inches	O.D. Neck Inches	Length Neck Inches	Dealer Pkg 5 Cards 1 Pc. per Card	OEM Bulk Pkg. 25 Pcs.	Screw Size	Ship Wt. Carton Lbs. DP/OEM Bulk
2-1/2	1-3/16	1-1/2	505 DP CHR	505 000 CHR	8	2.3/9.8



**FIG. 505**

**Note: All of the Above Vents are Designed to Meet the Requirements of U.S.C.G. Safety Standards January 31, 1977, for Gasoline Fuel Systems 33CFR183.**

## DECK PLATE KEYS & CABLE



Fig. 1247



FIG. 1247 - DECK PLATE KEY

**CONSTRUCTION:**

\* **BLACK PLASTIC**

Compact Size with Hole for Key Chain  
Will Fit PERKO 1-1/4" and 1-1/2" Deck Plates  
and Many Other "Slot" Type Opening Deck Plates



**ORDERING INFORMATION**

C. to C. of Lugs	Length Spade Inches	Length Overall Inches	Dealer Pkg. 10 Cards 1 Pc. per Card	OEM Bulk Pkg. 50 Pcs.	Ship Wt. Carton Lbs. DP/OEM Bulk
1-1/8	1	1-3/4	1247 DP BLK	1247 000 BLK	0.4/0.7

FIG. 1248 - DECK PLATE KEY

**CONSTRUCTION OPTIONS:**

\* **BLACK PLASTIC OR ZINC ALLOY**

The Keys For 1" Thru 1-1/2" Deck Plates Have a 1 Inch Spade on Handle That Allows Them to Fit Many Other "Slot" Type Opening Deck Plates.



Fig. 1248



**ORDERING INFORMATION**

For Deck Plate Size Inches	C. to C. of Lugs	Length Overall Inches	Material	Dealer Pkg. 10 Cards 1 Pc. per Card	Standard Pkg. - 50 Pc.	Ship Wt. Carton Lbs. DP/Std. Pkg.
1	5/8	3-3/8	Plastic	1248 006 DP	-----	0.4/---
1-1/4 & 1-1/2	1-1/8	3-3/8	Plastic	1248 7-8 DP	1248 7-8 BLK	0.7/1.4
2	1-11/16	4-3/8	Zinc	1248 009 DP	-----	2.0/--
2-1/2	2	4-3/8	Zinc	-----	1248 010 ZNC*	--/2

\*Standard Pkg. - 1 pc.

FIG. 826 - ADJUSTABLE DECK PLATE KEY

**CONSTRUCTION:**

\* **CHROME PLATED ZINC ALLOY**

\* **HARDENED STEEL PIN**

\* **WILL FIT SIZES UP TO 8 INCH DIAMETER**



Fig. 826

**ORDERING INFORMATION**

Length Overall Inches	Dealer Pkg. - 5 Cards 1 Pc. per Card	Ship Wt. Carton Lbs. Dealer Pkg.
8-1/2	826 DP CHR	3.4

FIG. 537 - RETAINING CABLE FOR DECK PLATES

**CONSTRUCTION:**

\* **STAINLESS STEEL CABLE AND FITTINGS**

\* **STAINLESS STEEL RING AND SELF TAPPING SCREW**



Fig. 537

**ORDERING INFORMATION**

Ring Dia. Inches	Fill Hose Size Inches	Length Cable Inches	Dealer Pkg. - 5 Cards 1 Pc. per Card	Ship Wt. Carton Lbs. Dealer Pkg.
1-3/8	1-1/2	7	537 DP	0.2
2	2	7	537 DP2*	0.2

\*Self Tapping Screw Not Included



Underwater Hdwe, Deck Plates, Fills and Vents

## CLEATS

**FIG. 572 - OPEN BASE CLEAT**

**CONSTRUCTION:**

**\* CHROME PLATED BRONZE**



**FIG. 572**



**ORDERING INFORMATION**

Length Overall Inches	Dimensions Base Inches	Max. Rope Size Inches	Dealer Pkg. 5 Cards 1 Pc. per Card	Standard Package - 1 Pc.	OEM Bulk Pkg. 10 Pcs.	Screw Size	Ship Wt. Carton Lbs. DP/Std Pkg/OEM Bulk
8	4 x 2-1/4	3/4	572 DP8 CHR	-----	572 008 CHR	1/4	7.4/--/14.3
10	5-1/16 x 2-13/16	7/8	-----	572 010 CHR	-----	5/16	--/2.2/--
12	6-1/16 x 2-7/8	1	-----	572 012 CHR	-----	5/16	--/3.2/--
15	7-3/8 x 3-5/8	1-1/2	-----	572 015 CHR	-----	3/8	--/8.0/--

**FIG. 1188 - OPEN BASE CLEAT**

**CONSTRUCTION:**

**\* CHROME PLATED ZINC ALLOY**



**FIG. 1188**



**ORDERING INFORMATION**

Length Overall Inches	Dimensions Base Inches	Max. Rope Size Inches	Dealer Pkg. 5 Cards 1 Pc. per Card	OEM Bulk Pkg.	OEM Bulk Pkg.	Screw Size	Ship Wt. Carton Lbs. DP/Std. Pkg./OEM Bulk
4	2-1/8 x 1-1/2	5/16	1188 DP4 CHR*	1188 004 CHR	50	10	3.1/--/15.1
6	3 x 1-3/4	7/16	1188 DP6 CHR	1188 006 CHR	50	10	3.2/--/30.0
8	4 x 2-1/8	5/8	1188 DP8 CHR	1188 008 CHR	25	1/4	4.4/--/20.4

\* Dealer Package, 5 cards - 2 Pcs. per card.

**FIG. 1210 - OPEN BASE CLEAT**

**CONSTRUCTION:**

**\* CHROME PLATED ZINC ALLOY**  
**\* STAINLESS STEEL STUDS, NUTS AND WASHERS**



**FIG. 1210**



**ORDERING INFORMATION**

Length Overall Inches	Dimensions Base Inches	Max. Rope Size Inches	Catalog Number	Std. Pkg.	OEM Bulk Pkg.	Stud Size	Ship Wt. Carton Lbs. Std Pkg./OEM Bulk
4	2-1/8 x 1-1/2	5/16	1210 004 CHR	10	50	12-24 x 1-1/4	3.7/19.5
6	3 x 1-3/4	7/16	1210 006 CHR	10	30	1/4-20 x 2	6.6/21.8

## GLEATS



**Fig. 566**

**FIG. 566 - CLOSED BASE CLEAT**

**CONSTRUCTION:**

**\* CHROME PLATED ZINC ALLOY**



**ORDERING INFORMATION**

Length Overall Inches	Dimensions Base Inches	Max. Rope Size Inches	Dealer Pkg. 5 Cards 2 Pcs. per Card	Screw Size	Ship Wt. Carton Lbs. Dealer Pkg.
2	2-3/16 x 1-1/8	5/16	566 DP2 CHR	6	1.3
3	3-1/8 x 1-1/2	3/8	566 DP3 CHR	8	3.6
4-1/2	4-7/16 x 1-7/8	1/2	566 DP4 CHR	10	6.1



**Fig. 1252**

**FIG. 1252 - OPEN BASE CLEAT**

**CONSTRUCTION:**

**\* CHROME PLATED ZINC ALLOY**



**ORDERING INFORMATION**

Length Overall Inches	Dimensions Base Inches	Max. Rope Size Inches	Dealer Pkg. 5 Cards 2 Pcs. per Card	OEM Bulk Pkg. 50 Pcs.	Screw Size	Ship Wt. Carton Lbs. DP/OEM Bulk
6-1/2	3 x 1-1/8	3/4	1252 DP CHR	1252 000 CHR	1/4	4.6/34.5

Deck Hardware



**Fig. 530**

**FIG. 530 - OPEN BASE CLEAT**

**CONSTRUCTION:**

**\* PLAIN ALUMINUM**



**ORDERING INFORMATION**

Length Overall Inches	Dimensions Base Inches	Max. Rope Size Inches	Standard Package - 1 Pc.	Screw Size	Ship Wt. Carton Lbs. Std. Pkg.
8	4 x 2-1/4	3/4	530 008 ALU	1/2	1.2
10	4-1/2 x 3	7/8	530 010 ALU	1/2	2.0
12	6-1/2 x 2-7/8	1	530 012 ALU	5/8	4.0
15	7 x 3-1/4	1-1/2	530 015 ALU	3/4	5.6

## CLEATS

**FIG. 545 - CLEAT**

**CONSTRUCTION:**

\* **PLAIN ALUMINUM**



**FIG. 545**



**ORDERING INFORMATION**

Length Overall Inches	Dimensions Base Inches	Max. Rope Size Inches	Dealer Pkg. 5 Cards 2 Pcs. per Card	OEM Bulk Package	OEM Bulk Pkg Pcs/Pkg	Screw Size	Ship Wt. Carton Lbs. DP/OEM Bulk
3	1-1/2 x 5/8	1/4	545 DP3 ALU	-----	----	8	0.8/--
4	1-5/8 x 3/4	5/16	545 DP4 ALU	-----	----	10	1.2/--
5	2 x 7/8	3/8	545 DP5 ALU	-----	----	1/4	1.8/--
6	2-1/4 x 7/8	7/16	545 DP6 ALU**	545 006 ALU	50	1/4	3.0/10.2
*8	2-5/8 x 1-7/8	5/8	545 DP8 ALU**	545 008 ALU	25	1/4	4.8/8.8
*10	3-5/8 x 1-1/2	3/4	-----	545 010 ALU	5	5/16	--/3.0
*12	4 x 1-1/2	7/8	-----	545 012 ALU	5	5/16	--/4.1

\* These Sizes are Open Base, Balance of Sizes are Closed Base.

\*\* Dealer Package, 10 pcs., 1 Pc. per card.

**FIG. 544 - CLEAT**

**CONSTRUCTION:**

\* **CAST BRONZE**

\* **POLISHED OR CHROME PLATED**



**FIG. 544**



**ORDERING INFORMATION**

Overall Inches	Base Inches	Max. Rope Size Inches	Chrome Plated Bronze Dealer Pkg.	Dealer Pkg. - 5 Cards Pcs. per Card	Polished Bronze Standard Pkg.	Std. Pkg.	Screw Size	Ship Wt. Carton Lbs. DP/Std. Pkg.
3	1-1/2 x 5/8	1/4	544 DP3 CHR	2	544 003 POL	10	8	1.8/1.6
4	1-5/8 x 3/4	5/16	544 DP4 CHR	1	544 004 POL	10	10	1.4/1.3

## CLEATS

### FIG. 1305 - CLOSED BASE CLEAT



Fig. 1305

**CONSTRUCTION:**

- \* CHROME PLATED ZINC ALLOY
- \* BLACK PLASTIC BASE



**ORDERING INFORMATION**

Length Overall Inches	Max. Rope Size Inches	Dealer Package	Dealer Pkg. 5 Cards Pcs. per Card	OEM Bulk Pkg. 50 Pcs.	Screw Size	Ship Wt. Carton Lbs. DP/OEM Bulk
4-1/2	3/8	1305 DP1 CHR	2	1305 001 CHR	10	3.4/14.6
6	1/2	1305 DP2 CHR	1	1305 002 CHR	1/4	3.6/15.5

### FIG. 1316 - OPEN BASE CLEAT



Fig. 1316

**CONSTRUCTION:**

- \* CHROME PLATED ZINC ALLOY
- \* BLACK PLASTIC BASE
- \* STAINLESS STEEL STUDS, NUTS AND WASHERS

**ORDERING INFORMATION**

Length Overall Inches	Max. Rope Size Inches	Catalog Number	Std. Pkg.	OEM Bulk Pkg.	Stud Size	Ship Wt. Carton Lbs. Std. Pkg./OEM Bulk
4-1/2	3/8	1316 001 CHR	10	50	12-24 x 1-1/2	0.4/17.6
6	1/2	1316 002 CHR	5	40	1/4 x 1-1/2	0.7/27.9

### FIG. 1306 - OPEN BASE CLEAT



Fig. 1306

**CONSTRUCTION:**

- \* CHROME PLATED ZINC ALLOY
- \* BLACK PLASTIC BASE



**ORDERING INFORMATION**

Length Overall Inches	Max. Rope Size Inches	Dealer Package	Dealer Pkg. 5 Cards Pcs. per Card	OEM Bulk Pkg. 50 Pcs.	Screw Size	Ship Wt. Carton Lbs. DP/OEM Bulk
4-1/2	3/8	1306 DP1 CHR	2	1306 001 CHR	10	2.9/12.3
6	1/2	1306 DP2 CHR	1	1306 002 CHR	1/4	3.2/29.3

### FIG. 1326 - OPEN BASE CLEAT



Fig. 1326

**CONSTRUCTION:**

- \* CHROME PLATED ZINC ALLOY
- \* BLACK PLASTIC BASE



**ORDERING INFORMATION**

Length Overall Inches	Dimensions Base Inches	Max. Rope Size Inches	Dealer Pkg. 5 Cards 1 Pc. per Card	OEM Bulk Pkg. 50 Pcs.	Screw Size	Ship Wt. Carton Lbs. DP/OEM Bulk
5-3/4	3-5/8 x 7/8	1/2	1326 DP2 CHR	1326 002 CHR	1/4	2.2/18.9

## CHOCKS

**FIG. 119 - STRAIGHT CHOCK**

**CONSTRUCTION:**

**\* CHROME PLATED BRONZE**



**ORDERING INFORMATION**

Max. Rope Size Inches	Length Overall Inches	Width Inches	Dealer Pkg 5 Cards 1 Pc. per Card	OEM Bulk Pkg. 5 Pcs.	Screw Size	Ship Wt. Carton Lbs. DP/OEM Bulk
3/4	4	7/8	119 DP4 CHR	119 004 CHR	8	2.0/1.7
1	6	1-1/8	119 DP6 CHR	-----	12	3.9/--

**FIG. 119**

**FIG. 1230 - STRAIGHT CHOCKS**

**CONSTRUCTION:**

**\* CHROME PLATED ZINC ALLOY**



**ORDERING INFORMATION**

Max. Rope Size Inches	Length Overall Inches	Width Inches	Dealer Pkg 10 Cards 1 Pair per Card	OEM Bulk Pkg. 50 Pair	Screw Size	Ship Wt. Carton Lbs. DP/OEM Bulk
3/4	4	7/8	1230 DP CHR	1230 000 CHR	8	4.7/21.4

**FIG. 1230**

**FIG. 1223 - SKENE BOW CHOCKS**

**CONSTRUCTION:**

**\* CHROME PLATED ZINC ALLOY**



**ORDERING INFORMATION**

Max. Rope Size Inches	Length Overall Inches	Width Inches	Dealer Pkg 5 Cards 1 Pair per Card	OEM Bulk Pkg. 50 Pair	Screw Size	Ship Wt. Carton Lbs. DP/OEM Bulk
1/2	3-1/2	7/8	1223 DP CHR	1223 000 CHR	8	3.2/14.0

**FIG. 1223**

## DECK PIPES

### FIG. 750 - ROPE AND CHAIN DECK PIPE

#### CONSTRUCTION:

- \* **CHROME PLATED BRONZE**

The Cover Has a Hook for Hanging Chain and a Stainless Steel Cable Retainer.



FIG. 750



#### ORDERING INFORMATION

Opening For Chain Size Inches	Dimensions Flange Inches	Height Overall Inches	Dealer Pkg. 5 Cards 1 Pc. per Card	Screw Size	Ship Wt. Carton Lbs. Dealer Pkg.
3/8	5-1/4 x 4	1-3/8	750 DP CHR	8	9.5

Spare Cover with Hook and Cable, Cat. No. 750 DP 99A

### FIG. 1057 - ROPE DECK PIPE

#### CONSTRUCTION:

- \* **HIGH IMPACT BLACK OR WHITE PLASTIC**
- \* **U.V. STABILIZED, FIBER REINFORCED**
- \* **HINGED, SNAP-DOWN COVER**
- \* **IMPROVED HINGE DESIGN ALLOWS OPEN COVER TO LAY FLAT**

IMPROVED PRODUCT



FIG. 1057 WHT



FIG. 1057 BLK



#### ORDERING INFORMATION

Color	Maximum Rope Size Inches	O.D. Flange Inches	Dealer Pkg. 5 Cards 1 Pc. per Card	OEM Bulk Pkg. 25 Pcs.	Screw Size	Ship Wt. Carton Lbs. DP/OEM Bulk
Black	7/8	3-3/4	1057 DP BLK	1057 000 BLK	8	1.7/5.9
White	7/8	3-3/4	1057 DP WHT	1057 000 WHT	8	1.7/6.1

### FIG. 757 - ROPE DECK PIPE

#### CONSTRUCTION:

- \* **CHROME PLATED ZINC ALLOY**



FIG. 757



#### ORDERING INFORMATION

Maximum Rope Size Inches	O.D. Flange Inches	Dealer Pkg. 5 Cards 1 Pc. per Card	OEM Bulk Pkg. 10 Pcs.	Screw Size	Ship Wt. Carton Lbs. DP/OEM Bulk
1	3-3/8	757 DP CHR	757 000 CHR	8	3.0/5.5



## MOORING BITT, HAWSE HOLE PLATE & LIFTING EYES

**FIG. 608 - MOORING BITT**

**CONSTRUCTION:**

\* **CHROME PLATED BRONZE, HOLLOW**

**ORDERING INFORMATION**

Dimensions Base Inches	Height Inches	Standard Pkg. 1 Pc.	Bolt Size	Ship Wt. Carton Lbs. Std. Pkg.
4-1/4 x 4-1/4	3-1/2	608 002 CHR	1/4	2.3
5 x 5	4-3/4	608 02A CHR	3/8	3.3
6 x 6	5	608 003 CHR	3/8	5.8



**FIG. 608**

**FIG. 434 - LIFTING EYE AND CLEAT**

**CONSTRUCTION:**

\* **CHROME PLATED MANGANESE BRONZE  
SAFE WORKING LOAD 4000 POUNDS\***



**ORDERING INFORMATION**

For Rod Threaded Inches	I.D. Eye Inches	Length Overall Inches	Dimensions Base Inches	Dealer Pkg. 5 Cards 1 Pc. per Card	OEM Bulk Pkg 10 Pcs.	Screw Size	Ship Wt. Carton Lbs. DP/OEM Bulk
5/8 x 11	1-1/16	5-1/16	3-1/2 x 2-1/2	434 DP CHR	434 000 CHR	10	7.5/15.7



**FIG. 434**

**FIG. 429 - LIFTING EYE**

**CONSTRUCTION:**

\* **CHROME PLATED MANGANESE BRONZE WITH INTEGRAL FLANGE  
SAFE WORKING LOAD 3000 POUNDS\***

**ORDERING INFORMATION**

For Rod Threaded Inches	I.D. Eye Inches	O.D. Eye Inches	O.D. Base Inches	Standard Pkg. - 1 Pc.	Screw Size	Ship Wt. Carton Lbs. Std. Pkg.
5/8 x 11	1-1/2	2-1/4	2-1/4	429 000 CHR	8	1.3



**FIG. 429**

**FIG. 752 - HAWSE HOLE PLATE**

**CONSTRUCTION:**

\* **CHROME PLATED BRONZE**

**ORDERING INFORMATION**

Dimensions Outside Inches	Dimensions Inside Inches	Length Spigot Inches	Std. Pkg. - 1 Pc. OEM Pkg. - 10 Pcs.	Screw Size	Ship Wt. Carton Lbs. Std. Pkg./OEM Bulk
4-1/4 x 6	2-1/8 x 4-1/8	1-1/4	752 000 CHR	1/4	1.7/12.7



**FIG. 752**

Deck Hardware

**\*IMPORTANT NOTE: THE SAFE WORKING LOAD INFORMATION GIVEN FOR THE ITEMS ABOVE IS BASED ON A STRAIGHT AXIAL PULL. THIS INFORMATION WOULD NOT APPLY IN CASES WHERE INSTALLATION OR USE CREATES ANGULAR LOADING SINCE THESE VARIATIONS MAKE IT IMPRACTICABLE TO OFFER ACCURATE TEST DATA.**

## BOW & TRANSOM EYES

**NOTE: THE BOW EYES AND TRANSOM EYES ILLUSTRATED ON THIS PAGE ARE NOT DESIGNED TO BEAR THE WEIGHT OF THE VESSEL AND THEREFORE SHOULD NOT BE USED FOR LIFTING**

**FIG. 237 - BOW EYE**

**CONSTRUCTION:**

- \* NON-MAGNETIC 300 SERIES STAINLESS STEEL SHANK
- \* STAINLESS STEEL NUTS & WASHERS

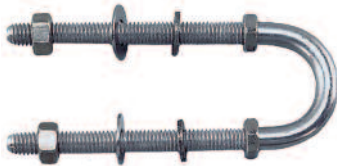

**FIG. 237**

**ORDERING INFORMATION**

Length Shank Inches	O.D. Shank Inches	I.D. Eye Inches	Length Thread Inches	Dealer Pkg. 10 Cards 1 Pc. per Card	Ship Wt. Carton Lbs. Dealer Pkg.	Safe Working Load Pounds*
3	5/16	1	3	237 DP1 STS	2.8	1800
6	5/16	1	6	237 DP2 STS	3.3	1800
3	3/8	1-1/8	3	*237 DP3 STS	2.0	3000
3-1/4	1/2	1-1/2	3-1/4	*237 DP4 STS	4.4	4600

\* Dealer Pkg., 5 cards, 1 Pc. per card

**FIG. 236 - TRANSOM EYE FOR USE AS TOWING OR LASHING EYE.**

**CONSTRUCTION:**

- \* NON-MAGNETIC 300 SERIES STAINLESS STEEL SHANK
- \* STAINLESS STEEL FINISHING PLATE, NUTS & WASHERS

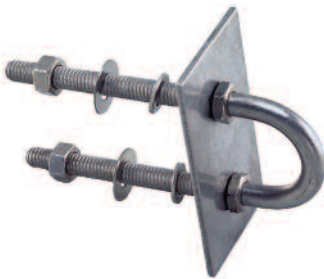

**FIG. 236**

**ORDERING INFORMATION**

Length Shank Inches	O.D. Shank Inches	I.D. Eye Inches	Dimensions Plate Inches	Dealer Pkg. 5 Cards 1 Pc. per Card	Ship Wt. Carton Lbs. Dealer Pkg.	Safe Working Load Pounds*
3	5/16	1	3 x 1-3/4	*236 DP1 STS	4.4	1800
3	3/8	1-1/8	3 x 1-3/4	236 DP3 STS	2.8	3000
3-1/4	1/2	1-1/2	4 x 1-3/4	236 DP4 STS	5.4	4600

\* Dealer Pkg., 10 cards, 1 Pc. per card

**FIG. 1235 - BOW EYE**

**CONSTRUCTION:**

- \* CHROME PLATED ZINC ALLOY EYE
- \* ZINC ALLOY PLATED STEEL "U" BOLT, NUTS & WASHERS

**SAFE WORKING LOAD 2000 POUNDS\***

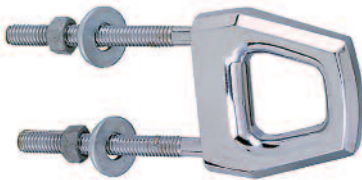

**FIG. 1235**

**ORDERING INFORMATION**

Length Shank Inches	O.D. Shank Inches	I.D. Eye Inches	Length Thread Inches	Dealer Pkg. 10 Cards 1 Pc. per Card	Ship Wt. Carton Lbs. Dealer Pkg.
3	5/16	1	2-3/4	1235 DP CHR	6.8

**\*IMPORTANT NOTE: THE SAFE WORKING LOAD INFORMATION GIVEN FOR THE ITEMS ABOVE IS BASED ON A STRAIGHT AXIAL PULL. THIS INFORMATION WOULD NOT APPLY IN CASES WHERE INSTALLATION OR USE CREATES ANGULAR LOADING SINCE THESE VARIATIONS MAKE IT IMPRACTICABLE TO OFFER ACCURATE TEST DATA.**

## ANCHOR CHOCKS & RIGGING TUBE

### CONSTRUCTION:

\* **CHROME PLATED BRONZE, POLISHED OR BURNISHED**

Size No. 1 Fits	
<b>Fortress Models</b> FX7-FX16	<b>Danforth® Models</b> H®500      T™570 H®960      T™1200 H®1500     T™1800 S®160      T™2500 S®300      T™3000 S®600      D™375 S®920      D™750 S®1300     D™1150 VSB™160   D™1650 VSB™13000 VSB™1900
<b>U.S. Anchor Mfg., INC. Models</b> 2-1/2, 4, 8, 13	
Size No. 2 Fits	
<b>Fortress Models</b> FX23-FX55	<b>Danforth® Models</b> H®1800     T™4000 H®3100     T™6000 H®3600     T™7000 D™2000 D™2500 S®1600 S®2000 S®3000 VSB™2500 VSB™3600
<b>U.S. Anchor Mfg., INC. Models</b> 18 & 22	



FIG. 903



### ORDERING INFORMATION

Polished Chrome Plated Bronze	Burnished Chrome Plated Bronze	Screw Size	Ship Wt. Carton Lbs. DP CHR/DP BUR
Dealer Pkg. - 5 Cds 1 Set per Card	Dealer Pkg. - 5 Cds 1 Set per Card		
903 DP1 CHR	903 DP1 BUR	10	12.1/12.0
903 DP2 CHR	903 DP2 BUR	10	13.6/13.5



Sample  
Clam Shell  
Package

### SPARE PARTS ORDERING INFORMATION

To Specify Size Replace the Sixth Digit With the Size Number (i.e. 903 001 99A or 903 B01 99A).

Spare Polished Chrome Shank Support, Cat. No. 903 000 99A.  
 Spare Pair, Polished Chrome Fluke Supports, Cat. No. 903 000 99B.  
 Spare Polished Chrome Crown Support, Cat. No. 903 000 99C.  
 Spare Knob, Cat. No. 1144 A00 BLK.

Spare Burnished Chrome Shank Support, Cat. No. 903 B00 99A.  
 Spare Pair, Burnished Chrome Fluke Supports, Cat. No. 903 B00 99B.  
 Spare Burnished Chrome Crown Support, Cat. No. 903 B00 99C.

### FIG. 357 - RIGGING TUBE

#### CONSTRUCTION:

\* **CHROME PLATED BRASS AND BRONZE**

For use with 2 Inch I.D. Hose to Pass Wiring Harnesses and Control Cables Through Transoms and Motorwell Bulkheads  
 Mounts in 2-1/8 Inch Diameter Hole



### ORDERING INFORMATION

O.D. Tube Inches	Length Overall Inches	O.D. Flange Inches	Dealer Pkg. 5 Cards 1 Pc. per Card	OEM Bulk Pkg. 25 Pcs.	Screw Size	Ship Wt. Carton Lbs. DP/OEM Bulk
2	4-1/8	3-1/8	357 DP1 CHR	357 001 CHR	8	3.1/12.9

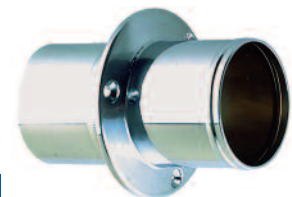

FIG. 357

## HANDLES

**FIG. 1234 - BOW HANDLE FOR DAYSAILERS**



**FIG. 1234**

**CONSTRUCTION:**

\* **CHROME PLATED ZINC ALLOY**



**ORDERING INFORMATION**

Length Overall Inches	Ht. Above Deck Inches	Dealer Pkg. 5 Cards 1 Pc. per Card	OEM Bulk Pkg. 50 Pcs.	Screw Size	Ship Wt. Carton Lbs. DP/OEM Bulk
6-1/2	2	1234 DP CHR	1234 000 CHR	8	2.8/18.6

**FIGS. 1336 & 1346 - HANDLES**

**CONSTRUCTION:**

\* **CHROME PLATED ZINC ALLOY**

\* **BLACK PLASTIC BASE**

**FIG 1346**

\* **STAINLESS STEEL STUDS, NUTS AND WASHERS**



**ORDERING INFORMATION**

Length Overall Inches	Length Inside Inches	Height Inside Inches	Dealer Pkg. 5 Cards 2 Pcs. per Card	OEM Bulk Pkg. 50 Pcs.	Screw Size	Ship Wt. Carton Lbs. DP/OEM Bulk
6-1/4	3-1/2	1	1336 DP CHR	1336 000 CHR	1/4	6.4/30.5
Length Overall Inches	Length Inside Inches	Height Inside Inches	Std. Pkg. - 10 Pcs. OEM Bulk Pkg. - 50 Pcs.	Stud Size	Std. Pkg./OEM Bulk	Ship Wt. Carton Lbs.
6-1/4	3-1/2	1	1346 000 CHR	1/4-20 x 1-1/2		7.0/36.7



**FIG. 1336**



**FIG. 1346**

**FIG. 1222 - HANDLE**

**CONSTRUCTION:**

\* **CHROME PLATED ZINC ALLOY**



**ORDERING INFORMATION**

Length Overall Inches	Length Inside Inches	Height Inside Inches	Dealer Pkg. 5 Cards 2 Pcs. per Card	OEM Bulk Pkg. 100 Pcs.	Screw Size	Ship Wt. Carton Lbs. DP/OEM Bulk
5-3/4	3-5/8	1-1/4	1222 DP CHR	1222 000 CHR	8	3.2/23.7



**FIG. 1222**

**FIG. 1231 - HANDLE**

**CONSTRUCTION:**

\* **CHROME PLATED ZINC ALLOY**



**ORDERING INFORMATION**

Length Overall Inches	Length Inside Inches	Height Inside Inches	Dealer Pkg. 5 Cards 2 Pcs. per Card	OEM Bulk Pkg. 50 Pcs.	Screw Size	Ship Wt. Carton Lbs. DP/OEM Bulk
6	3-1/2	1-5/16	1231 DP CHR	1231 000 CHR	1/4	4.7/19.3



**FIG. 1231**

**FIG. 775 - HANDLE**

**CONSTRUCTION:**

\* **CHROME PLATED BRONZE**



**ORDERING INFORMATION**

Length Overall Inches	Length Inside Inches	Height Inside Inches	Dealer Pkg. 5 Cards 2 Pcs. per Card	OEM Bulk Pkg. 50 Pcs.	Screw Size	Ship Wt. Carton Lbs. DP/OEM Bulk
4-1/4	2-1/2	7/8	775 DP1 CHR	775 001 CHR	6	1.6/6.7
5-3/4	3-5/8	1-3/8	775 DP2 CHR	775 002 CHR	8	3.1/9.5



**FIG. 775**

## STEP PLATES & STEPS

### FIGS. 1043 & 1325 STEP PLATES

**CONSTRUCTION:**

\* **SOFT BLACK PLASTIC PADS**

**FIG. 1043 - CHROME PLATED BRONZE FRAMES**

**FIG. 1325 - CHROME PLATED ZINC ALLOY FRAMES**



**ORDERING INFORMATION**

Dimensions Inches	Dealer Pkg. 5 Cards 1 Pc. per Card	OEM Bulk Pkg. 50 Pcs.	Screw Size	Ship Wt. Carton Lbs. DP/OEM Bulk
8-3/4 x 3-1/4	1043 DP1 CHR	-----	6	4.6/--
11-1/2 x 5-3/4	1043 DP2 CHR	-----	8	10.3/--
8-3/8 x 2-1/4	1325 DP0 CHR*	1325 000 CHR	8	3.7/15.3
8-3/4 x 3-1/4	1325 DP1 CHR*	1325 001 CHR	8	5.3/22.9

\* Dealer Package 2 Pcs. per card.

Spare Pads for Size No. 0 (2 per bag), Cat. No. 1050 DP0 BLK.

Spare Pads for Size No. 1 (2 per bag), Cat. No. 1050 DP1 BLK.

Spare Pads for Size No. 2 (2 per bag), Cat. No. 1050 DP2 BLK.



**FIG. 1043**



**FIG. 1325**

### FIG. 1015 - STEP PLATE

**CONSTRUCTION:**

\* **CHROME PLATED BRASS FRAME**

\* **SOFT BLACK PLASTIC TREAD INSERT**



**ORDERING INFORMATION**

Dimensions Inches	Dealer Pkg. 5 Cards 2 Pcs. per Card	O.E.M. Bulk Pkg. 50 Pcs.	Screw Size	Ship Wt. Carton Lbs. DP/OEM Bulk
7-1/4 x 1-1/2	1015 DP CHR	1015 000 CHR	8	1.8/6.7



**FIG. 1015**

### FIGS. 351 & 501 - FIXED STEPS

**CONSTRUCTION:**

\* **CHROME PLATED BRONZE**



**ORDERING INFORMATION**

Dimensions Step Inches	Dimensions Bracket Inches	Dealer Pkg. 5 Cards 1 Pc. per Card	Standard Pkg. - 1 Pc.	Bolt Size	Ship Wt. Carton Lbs. DP/Std. Pkg.
6 x 4-1/4	6 x 2	351 DP CHR	-----	5/16 R.H.	11.4/--
11 x 4-1/2	11 x 2	-----	501 000 CHR	5/16 R.H.	--/4.6



**FIG. 351**



**FIG. 501**

### FIG. 344 - FOLDING STEP

**CONSTRUCTION:**

\* **CHROME PLATED BRONZE**

**STAINLESS STEEL SPRING HOLDS STEP  
IN OPEN OR CLOSED POSITION**



**ORDERING INFORMATION**

Dimensions Step Inches	Dimensions Bracket Inches	Projection Folded Inches	Dealer Pkg. 5 Cards 1 Pc. per Card	Bolt Size	Ship Wt. Carton Lbs. Dealer Pkg.
4-1/8 x 2-1/4	4-1/4 x 1-3/4	1-3/8	344 DP CHR	5/16 R.H.	8.3



**FIG. 344**



## FLAG POLE SOCKETS & FLAG STAFF

### FIGS. 218 & 219 - FLUSH FLAG POLE SOCKETS

**FIG. 219**  
**STERN**



**FIG. 218**  
**Bow**

**CONSTRUCTION:**

\* **CHROME PLATED BRONZE**

**FIG. 218 - Bow Socket**

**FIG. 219 - STERN SOCKET, 26° ANGLE**



**ORDERING INFORMATION**

I.D. Socket Inches	O.D. Flange Inches	Depth Socket Inches	Fig. 218 Dealer Pkg. - 5 Cds 1 Pc. per Card	Fig. 219 Dealer Pkg. - 5 Cds 1 Pc. per Card	Screw Size	Ship Wt. Carton Lbs.
3/4	2	1-1/2	218 DP1 CHR	219 DP1 CHR	8	1.9/3.3
1	2-3/8	1-3/4	218 DP2 CHR	219 DP2 CHR	8	3.1/3.7
1-1/4	2-5/8	2	218 DP3 CHR	219 DP3 CHR	8	3.8/4.7

### FIGS. 220 & 221 - UPRIGHT FLAG POLE SOCKETS

**FIG. 220**  
**Bow**



**FIG. 221**  
**STERN**

**CONSTRUCTION:**

\* **CHROME PLATED BRONZE**

**FIG. 220 - Bow Socket**

**FIG. 221 - STERN SOCKET, 13° ANGLE**



**ORDERING INFORMATION**

I.D. Socket Inches	O.D. Base Inches	Height Overall Inches	Fig. 220 Dealer Pkg. - 5 Cds 1 Pc. per Card	Fig. 221 Dealer Pkg. - 5 Cds 1 Pc. per Card	Screw Size	Ship Wt. Carton Lbs.
3/4	2-1/8	1-3/4	220 DP1 CHR	221 DP1 CHR	8	1.6/2.0
1	2-1/2	2	220 DP2 CHR	221 DP2 CHR	8	2.9/3.6
1-1/4	2-3/4	2-1/8	220 DP3 CHR	221 DP3 CHR	8	3.2/4.3

### FIGS. 1302 & 1322 - CLAMP-ON FLAG POLE SOCKETS

**CONSTRUCTION:**

\* **CHROME PLATED ZINC ALLOY WITH BLACK PLASTIC KNOB**

Fig. 1302 For Round Rail Sizes 3/4 to 1 Inch

Fig. 1322 For Square Rail Size 1-1/4 Inch

**FIG. 1302**



**FIG. 1322**

**ORDERING INFORMATION**

I.D. Socket Inches	Dimensions Bracket Inches	Dealer Pkg. 5 Cards 1 Pc. per Card	Ship Wt. Carton Lbs. Dealer Pkg.
3/4	2 x 1-3/4	1302 DP CHR	3.4
3/4	2 x 1-3/4	1322 DP CHR	3



### FIG. 495 - FLAG STAFF

**CONSTRUCTION:**

\* **CHROME PLATED ZINC ALLOY BASE AND TOP**

\* **ANODIZED ALUMINUM TUBE**

Sizes 2 and 3 For Use With

Fig. 1302 Clamp-On Socket Only



**ORDERING INFORMATION**

O.D. Base Inches	Length Overall Inches	Dealer Pkg. 5 Bags 1 Pc. per Bag	Ship Wt. Carton Lbs. Dealer Pkg.
1/2	14	495 DP1 CHR	1.5
3/4	14	495 DP2 CHR	1.7
3/4	18	495 DP3 CHR	2.0

**FIG. 495**

## FLAG POLES & SOCKET SETS

**Figs. 427, 428, 1277, 1278, 1304 & 1327 - FLAG POLES & SOCKETS**

### CONSTRUCTION:

- \* **FIG. 427 - CHROME PLATED BRASS POLE, CHROME PLATED BRONZE STRAIGHT SOCKET**
- \* **FIG. 428 - CHROME PLATED BRASS POLE, CHROME PLATED BRONZE ANGLED SOCKET**
- \* **FIG. 1277 - ALUMINUM POLE, CHROME PLATED ZINC ALLOY STRAIGHT SOCKET**
- \* **FIG. 1278 - ALUMINUM POLE, CHROME PLATED ZINC ALLOY ANGLED TEAR DROP SOCKET**
- \* **FIG. 1304 - ALUMINUM POLE, CHROME PLATED ZINC ALLOY CLAMP-ON SOCKET FOR ROUND RAILS**
- \* **FIG. 1327 - ALUMINUM POLE, CHROME PLATED ZINC ALLOY CLAMP-ON SOCKET FOR SQUARE RAILS**



- \* **FOR 16 INCH HIGH FLAGS**
- \* **INCLUDES ALLEN WRENCH AND THUMB SCREW FOR EASY DISASSEMBLY OF POLE AND SOCKET**
- \* **DP3 VERSION INCLUDES EMBROIDERED AMERICAN FLAG WITH EACH PACKAGE**



### ORDERING INFORMATION

Description	Base Style	Finish	Dealer Pkg. 5 Cards 1 Pc. per Card	Aprox. Pole Ht	Ship Wt. Carton Lbs. Dealer Pkg.
Pole & Socket	Straight	Chr Brass/Chr Bronze	427-DP2-CHR	31-1/2"	9.8
Pole, Socket & Flag	Straight	Chr Brass/Chr Bronze	427-DP3-CHR	31-1/2"	10.6
Pole & Socket	Angled	Chr Brass/Chr Bronze	428-DP2-CHR	31-1/2"	10.5
Pole, Socket & Flag	Angled	Chr Brass/Chr Bronze	428-DP3-CHR	31-1/2"	11.3
Pole & Socket	Straight	Alum/Chr Zinc Alloy	1277-DP2-CHR	31-1/2"	8.5
Pole, Socket & Flag	Straight	Alum/Chr Zinc Alloy	1277-DP3-CHR	31-1/2"	9.3
Pole & Socket	Angled	Alum/Chr Zinc Alloy	1278-DP2-CHR	31-1/2"	8.9
Pole, Socket & Flag	Angled	Alum/Chr Zinc Alloy	1278-DP3-CHR	31-1/2"	9.7
Pole & Socket	Clamp on (Round)	Alum/Chr Zinc Alloy	1304-DP2-CHR	18"	7.0
Pole, Socket & Flag	Clamp on (Round)	Alum/Chr Zinc Alloy	1304-DP3-CHR	18"	7.8
Pole & Socket	Clamp on (Square)	Alum/Chr Zinc Alloy	1327-DP2-CHR	18"	7.0
Pole, Socket & Flag	Clamp on (Square)	Alum/Chr Zinc Alloy	1327-DP3-CHR	18"	7.8

Deck Hardware

## GRAB RAIL POSTS, BOAT HOOK HOLDERS, POLE STORAGE CLIPS & SPRING CLAMPS

### FIGS. 380 & 380A - GRAB RAIL POSTS



**FIG. 380**  
**END POST**



**FIG. 380A**  
**CENTER POST**

**CONSTRUCTION:**

- \* HOLLOW, FOR 1 INCH O.D. TUBING
- \* CHROME PLATED BRONZE

**ORDERING INFORMATION**

Height Overall Inches	O.D. Base Inches	Fig. 380 & 380A Standard Pkg. - 1 Pc.	Screw Size	Ship Wt. Carton Lbs Standard Pkg.
3-3/8	2-1/2	380 000 CHR	8	0.8
3-3/8	2-1/2	380 A00 CHR	8	0.7

### FIG. 492 - BOAT HOOK HOLDERS



**FIG. 492**



**CONSTRUCTION:**

- \* STAINLESS STEEL



**ORDERING INFORMATION**

Maximum Pole O.D. Inches	Length Inches	Width Inches	Dealer Pkg. 10 Cards 1 Pair per Card	OEM Bulk Pkg. 50 Pair	Screw Size	Ship Wt. Carton Lbs. DP/OEM Bulk
1-1/2	3-1/2	1	492 DP STS	492 000 STS	6	2.2/8.2

### FIG. 477 - POLE STORAGE CLIPS



**FIG. 477**



**CONSTRUCTION:**

- \* SOFT BLACK PLASTIC
- \* FITS 3/4 INCH DIAMETER TUBING
- \* U.V. STABILIZED



**ORDERING INFORMATION**

For Pole O.D. Inches	Dimensions Inches	Dealer Pkg. 10 Cards 1 Pair per Card	OEM Bulk Pkg. 50 Pair	Screw Size	Ship Wt. Carton Lbs. DP/OEM Bulk
3/4	3/4 x 2-1/4 x 1-5/8	477 DP BLK	477 000 BLK	10	1.5/4.3

### FIG. 502 - SPRING CLAMPS



**FIG. 502**

**CONSTRUCTION:**

- \* STAINLESS STEEL



**ORDERING INFORMATION**

Minimum I.D. Inches	Maximum I.D. Inches	Projection Inches	Width Clamp Inches	Dealer Pkg. 10 Cards 1 Pair per Cd	OEM Bulk Pkg. 50 Pcs.	Screw Size	Ship Wt. Carton Lbs. DP/OEM Bulk
5/8	1-1/4	1-1/2	1/2	502 DP1 STS	502 001 STS	6	0.8/2.9
1	1-3/4	2-1/4	5/8	502 DP2 STS	502 002 STS	6	1.7/7.0





## AXE BRACKET, RING BUOY HOLDER & EYE STRAPS

**FIG. 325 - AXE BRACKETS**

**CONSTRUCTION:**

\* **STAINLESS STEEL**



**ORDERING INFORMATION**

For Blade Width Inches	Standard Pkg. - 10 Sets	Socket Screw Size	Bracket Screw Size	Ship Wt. Carton Lbs. Standard Pkg.
6	325 000 STS	10 R.H.	6	3.1



**FIG. 325**

**FIG. 1017 - RING BUOY HOLDER**

**CONSTRUCTION OPTIONS:**

\* **CHROME PLATED BRASS**

\* **PLAIN BRASS**



**ORDERING INFORMATION**

Width Mounting Plate Inches	Height Overall Inches	Chrome Plated Brass Dealer Pkg. - 5 Cards 1 Pc. per Card	Plain Brass Standard Pkg. - 5 Pcs.	Screw Size	Ship Wt. Carton Lbs. DP/Std. Pkg.
3	4-1/2	1017 DP CHR	1017 000 PLB	8	2.9/2.3



**FIG. 1017**

**FIG. 1242 - EYE STRAP**

**CONSTRUCTION:**

\* **CHROME PLATED ZINC ALLOY**



**ORDERING INFORMATION**

Length Overall Inches	I.D. Eye Inches	Dealer Pkg. 10 Cards 5 Pcs. per Card	OEM Bulk Pkg. 100 Pcs.	Screw Size	Ship Wt. Carton Lbs. DP/OEM Bulk
1-7/8	5/16	1242 DP CHR	1242 000 CHR	8	1.5/2.3



**FIG. 1242**



Deck Hardware

**FIG. 562 - EYE STRAP**

**CONSTRUCTION:**

\* **300 SERIES STAINLESS STEEL**



**ORDERING INFORMATION**

Length Overall Inches	I.D. Eye Inches	Dealer Pkg. 10 Cards 5 Pcs. per Card	OEM Bulk Pkg. 100 Pcs.	Screw Size	Ship Wt. Carton Lbs. DP/OEM Bulk
1-5/8	1/4	562 DP STS	562 000 STS	10	0.7/0.8



**FIG. 562**



## WINDSHIELD WIPER, ROPE CLAMP, DOCK LINE SPRING & ROPE TIGHTENERS



**Fig. 533**

**FIG. 533 - HAND WINDSHIELD WIPER**

**CONSTRUCTION:**

- \* CHROME PLATED ZINC ALLOY
- \* 400 SERIES STAINLESS STEEL ARM AND BLADE HOLDER

For Straight and Curved Windshields, the Arm is Extendable from 6-3/4 to 10-1/2 Inches (Length Overall is 8 to 11-1/2 Inches), and the Spring Tension is Adjustable.



**ORDERING INFORMATION**

O.D. Shaft Inches	Max. Thickness of Panel Inches	Length Handle Inches	Length Blade Inches	Dealer Pkg. 5 Pcs. 1 Pc. per Card	Ship Wt. Carton Lbs. Dealer Pkg.
3/8	1-1/8	2-3/8	12	533 DP STS	4.2

Spare Arm, Cat. No. 533 000 99A.  
Spare Handle, Cat. No. 533 000 99D.

Spare Curved Blade, Cat. No. 533 000 99B.

**FIG. 1226 - ROPE CLAMP**



**Fig. 1226**

**CONSTRUCTION:**

- \* CHROME PLATED ZINC ALLOY
- \* FOR 1/8 OR 3/16 INCH ROPE



**ORDERING INFORMATION**

Length Overall Inches	Width Inches	Dealer Pkg. - 25 Cards 2 Pcs. per Card	OEM Bulk Pkg. 100 Pcs.	Ship Wt. Carton Lbs. DP/OEM Bulk
1-1/4	11/16	1226 DP CHR	1226 000 CHR	1.6/6.1



**FIG. 759 - DOCK LINE SPRING**

**FIG. 754 - ROPE TIGHTENER**



**Figs. 759 & 754**

**CONSTRUCTION:**

- \* FIG. 759 GALVANIZED SPRING STEEL
- \* FIG. 754 ZINC ALLOY PLATED SPRING STEEL



**ORDERING INFORMATION**

For Rope Size Inches	Length Overall Inches	O.D. Inches	Compression Inches	Dealer Pkg. 10 Cards 2 Pcs. per Card	Standard Package - 5 Pcs.	Ship Wt. Carton Lbs. DP/Std. Pkg.
1/2	10	1-1/2	4-1/2	-----	759 001 ZNC	--/4.6
1/4	4-3/4	7/8	1-3/4	754 DP CAD	-----	4.0/--

Deck Hardware

**FIG. 732 - ROPE TIGHTENER**



**Fig. 732 ZINC**

**CONSTRUCTION OPTIONS:**

- \* ZINC ALLOY PLATED SPRING STEEL



**ORDERING INFORMATION**

Finish	Length Normal Inches	Length Compressed Inches	O.D. Inches	Dealer Pkg. - 5 Cards 2 Pcs. per Card	Ship Wt. Carton Lbs. Dealer Pkg.
Zinc Alloy	4	5	1	732 DP CAD	2.5



## ROPE PULLEYS & ROPE GUIDES

**FIG. 565 - SWIVEL ROPE PULLEY**

**CONSTRUCTION:**

- \* STAINLESS STEEL WITH STRAP
- \* WHITE PLASTIC SHEAVE
- \* MAXIMUM ROPE SIZE 1/4 INCH



**ORDERING INFORMATION**

O.D. Sheave Inches	Length Overall Inches	Length Strap Inches	Dealer Pkg. - 5 Cards 2 Pcs. per Card	Screw Size	Ship Wt. Carton Lbs. Dealer Pkg.
2-5/16	3-3/4	1-5/8	565 DP	10	1.7



**FIG. 565**



**FIG. 634 - SWIVEL SNAP HOOK ROPE PULLEY**

**CONSTRUCTION:**

- \* STAINLESS STEEL
- \* WHITE PLASTIC SHEAVE
- \* MAXIMUM ROPE SIZE 1/4 INCH



**ORDERING INFORMATION**

O.D. Sheave Inches	Length Overall Inches	Opening Snap Throat Inches	Dealer Pkg. - 5 Cards 2 Pcs. per Card	Ship Wt. Carton Lbs. Dealer Pkg.
2-5/16	4-5/8	1/2	634 DP	1.9



**FIG. 634**



**FIG. 1243 - ROPE GUIDE**

**CONSTRUCTION:**

- \* CHROME PLATED ZINC ALLOY
- \* BLACK PLASTIC SHEAVE



**ORDERING INFORMATION**

Maximum Rope Size Inches	O.D. Sheave Inches	Dimensions Base Inches	Dealer Pkg. 10 Cards 1 Pc. per Card	Screw Size	Ship Wt. Carton Lbs. Dealer Pkg.
1/4	7/8	2 x 3/4	1243 DP CHR	8	1.3



**FIG. 1243**



**FIGS. 1256 & 1261 - ROPE GUIDES**

**CONSTRUCTION:**

- \* CHROME PLATED ZINC ALLOY



**ORDERING INFORMATION**

I.D. Hole Inches	Dimensions Base Inches	Dealer Pkg. 25 Cards 2 Pcs. per Card	OEM Bulk Pkg. 100 Pcs.	Screw Size	Ship Wt. Carton Lbs. DP/OEM Bulk
5/16	1-1/4 x 3/4	1256 DP CHR	1256 000 CHR	6	2.0/2.9
5/16	1-1/4 x 3/4	1261 DP CHR	1261 000 CHR	6	1.9/2.7



**FIG. 1261**



**FIG. 1256**



## FENDER LOCK, HOOKS & EYE SNAP



Fig. 1299



Fig. 1299 - FENDER LOCK

**CONSTRUCTION:**

\* **CHROME PLATED ZINC ALLOY**

The Eye is to be Permanently Attached to the Fender Line.



**ORDERING INFORMATION**

I.D. Eye Inches	O.D. Flange Inches	Dealer Pkg. 10 Cards 2 Pcs. per Card	OEM Bulk Pkg. 50 Pcs.	Screw Size	Ship Wt. Carton Lbs. DP/OEM Bulk
3/8	1-1/2	1299 DP CHR	1299 000 CHR	8	1.5/3.1

Spare Eye, Cat. No. 1299 000 99A.



Fig. 1246



Fig. 1246 - FENDER HOOK

**CONSTRUCTION:**

\* **CHROME PLATED ZINC ALLOY**



**ORDERING INFORMATION**

Maximum Rope Size Inches	Dimensions Plate Inches	Dealer Pkg. - 10 Cards 2 Pcs. per Card	Screw Size	Ship Wt. Carton Lbs. Dealer Pkg.
3/8	1-3/4 x 1-1/4	1246 DP CHR	6	1.9

Fig. 1309 - SNAP TYPE FENDER HOOK



Fig. 1309



**CONSTRUCTION:**

\* **CHROME PLATED ZINC ALLOY**



**ORDERING INFORMATION**

Maximum Rope Size Inches	Dimensions Plate Inches	Dealer Pkg. 10 Cards 2 Pcs. per Card	OEM Bulk Pkg. 100 Pcs.	Screw Size	Ship Wt. Carton Lbs. DP/OEM Bulk
1/4	1-9/16 x 1-3/8	1309 DP CHR	1309 000 CHR	6	2.1/8.5

Fig. 1289 - SWIVEL EYE SNAP



Fig. 1289



**CONSTRUCTION:**

\* **CHROME PLATED ZINC ALLOY**

\* **INTERLOCKING TONGUE**



**ORDERING INFORMATION**

I.D. Eye Inches	Length Overall Inches	Dealer Pkg. - 10 Cards 1 Pc. per Card	Ship Wt. Carton Lbs. Dealer Pkg.
5/8	3	1289 DP CHR	1.9

**NOTE: THIS SNAP SHOULD NOT BE USED FOR LIFTING, WINCHING, TOWING, MOORING OR LIKE APPLICATIONS.**

## ROWLOCK HORNS & SOCKETS

**FIG. 828 - RIBBED TYPE ROWLOCK HORNS**

**CONSTRUCTION:**

\* **PLAIN MANGANESE BRONZE**



**ORDERING INFORMATION**

O.D. Shank Inches*	Length Shank Inches	Between Horns Inches	Dealer Pkg. - 5 Cards 1 Pair per Card	Ship Wt. Carton Lbs. Dealer Pkg.
1/2	2-1/8	2	828 DP PLB	5.0



**FIG. 828**

**FIG. 829 - ROUND TYPE ROWLOCK HORNS**

**CONSTRUCTION:**

\* **PLAIN MANGANESE BRONZE**



**ORDERING INFORMATION**

O.D. Shank Inches*	Length Shank Inches	I.D. Horn Inches	Dealer Pkg. - 5 Cards 1 Pair per Card	Ship Wt. Carton Lbs. Dealer Pkg.
1/2	2-1/8	2	829 DP0 PLB	4.9
1/2	2-1/8	2-1/4	829 DP1 PLB	5.7



**FIG. 829**

**FIG. 830 - NORTH RIVER TYPE ROWLOCK HORNS**

**CONSTRUCTION:**

\* **PLAIN MANGANESE BRONZE**



**ORDERING INFORMATION**

O.D. Shank Inches*	Length Shank Inches	Between Horns Inches	Dealer Pkg. - 5 Cards 1 Pair per Card	Ship Wt. Carton Lbs. Dealer Pkg.
1/2	2-1/8	2-1/8	830 DP PLB	4.3



**FIG. 830**

**FIGS. 831, 832 & 833 - ROWLOCK SOCKETS**

**CONSTRUCTION:**

\* **PLAIN MANGANESE BRONZE**



**ORDERING INFORMATION**

Mount	Length Inches	Width Inches	Depth Inches	Dealer Pkg. 5 Cards 1 Pair per Card	Ship Wt. Carton Lbs. Dealer Pkg.
Top	2-3/8	7/8	1	831 DP PLB	2.6
Side	3-5/8	---	1-3/8	832 DP PLB	2.8
Edge	4	3/4	1-3/4	833 DP PLB	3.3

Screw Size #10.

\*Note: The Plain Bronze Oarlocks listed on this page were designed for use only with the matching plain bronze rowlock sockets Figs 831-833.



**FIG. 831**



**FIG. 832**



**FIG. 833**

## ROWLOCK HORNS

**FIG. 1227 - NORTH RIVER TYPE ROWLOCK HORNS**



**FIG. 1227**

**CONSTRUCTION OPTIONS:**

- \* **PLAIN OR CHROME PLATED**
- ZINC ALLOY**



**ORDERING INFORMATION**

Finish	O.D. Shank Inches	Length Shank Inches	Between Horns Inches	Dealer Pkg. 10 Cards 1 Pair per Card	Ship Wt. Carton Lbs. Dealer Pkg.
Plain	1/2	1-3/4	1-3/4	1227 DP ZNC	6.3
Chrome	1/2	1-3/4	1-3/4	1227 DP CHR	6.3

**FIG. 1267 - ROUND TYPE ROWLOCK HORNS**



**FIG. 1267**

**CONSTRUCTION OPTIONS:**

- \* **PLAIN OR CHROME PLATED**
- ZINC ALLOY**



**ORDERING INFORMATION**

Finish	O.D. Shank Inches	Length Shank Inches	I.D. Horns Inches	Dealer Pkg. 10 Cards 1 Pair per Card	Ship Wt. Carton Lbs. Dealer Pkg.
Plain	1/2	1-3/4	2	1267 DP ZNC	6.8
Chrome	1/2	1-3/4	2	1267 DP CHR	6.8

**FIG. 1262 - RIBBED TYPE ROWLOCK HORNS**



**FIG. 1262**

**CONSTRUCTION OPTIONS:**

- \* **PLAIN OR CHROME PLATED**
- ZINC ALLOY**



**ORDERING INFORMATION**

Finish	O.D. Shank Inches	Length Shank Inches	Between Horns Inches	Dealer Pkg. 10 Cards 1 Pair per Card	Ship Wt. Carton Lbs. Dealer Pkg.
Plain	1/2	1-3/4	1-3/4	1262 DP ZNC	5.9
Chrome	1/2	1-3/4	1-3/4	1262 DP CHR	6.0

## ROWLOCK SOCKETS, OAR LEATHERS & BUTTONS

### FIG. 1185 - TOP MOUNT ROWLOCK SOCKETS

#### CONSTRUCTION OPTIONS:

- \* PLAIN OR CHROME PLATED ZINC ALLOY
- \* BLACK PLASTIC BEARINGS

\* FOR USE WITH FIGS. 1227, 1262 & 1267 ROWLOCK HORNS



#### ORDERING INFORMATION

Finish	Length Inches	Width Inches	Depth Inches	Dealer Pkg. 10 Cards 1 Pair per Card	OEM Bulk Pkg. 50 Pair	Ship Wt. Carton Lbs. DP/OEM Bulk
Plain	2-7/8	1-1/8	1-1/8	1185 DP ZNC	1185 000 ZNC	4.0/17.0
Chrome	2-7/8	1-1/8	1-1/8	1185 DP CHR	1185 000 CHR	4.0/17.5

Screw Size #10. Spare Plastic Bearing, Cat. No. 1155 000 BLK.



Fig. 1185

### FIG. 1186 - EDGE MOUNT ROWLOCK SOCKETS

#### CONSTRUCTION OPTIONS:

- \* PLAIN OR CHROME PLATED ZINC ALLOY
- \* BLACK PLASTIC BEARINGS
- \* FOR USE WITH FIGS. 1227, 1262 & 1267 ROWLOCK HORNS



#### ORDERING INFORMATION

Finish	Length Inches	Width Inches	Depth Inches	Dealer Pkg. 10 Cards 1 Pair per Card	Ship Wt. Carton Lbs. Dealer Pkg.
Plain	4	7/8	1-1/8	1186 DP ZNC	6.9
Chrome	4	7/8	1-1/8	1186 DP CHR	6.7

Screw Size #10. Spare Plastic Bearing, Cat. No. 1155 000 BLK.



Fig. 1186

### FIG. 1187 - SIDE MOUNT ROWLOCK SOCKETS

#### CONSTRUCTION OPTIONS:

- \* PLAIN OR CHROME PLATED ZINC ALLOY
- \* BLACK PLASTIC BEARINGS
- \* FOR USE WITH FIGS. 1227, 1262 & 1267 ROWLOCK HORNS



#### ORDERING INFORMATION

Finish	Length Inches	Depth Inches	Dealer Pkg. - 10 Cards 1 Pair per Card	Ship Wt. Carton Lbs. Dealer Pkg.
Plain	4	1-1/4	1187 DP ZNC	4.3
Chrome	4	1-1/4	1187 DP CHR	4.3

Screw Size #10. Spare Plastic Bearing, Cat. No. 1155 000 BLK.



Fig. 1187

### FIG. 233 - OAR LEATHERS & BUTTONS

#### CONSTRUCTION:

- \* LEATHER



#### ORDERING INFORMATION

Dimensions Leather Inches	Dimensions Button Inches	Dealer Pkg. 5 Cards 1 Pair per Card	Ship Wt. Carton Lbs. Dealer Pkg.
7 x 6-1/2	1/2 x 13	233 DP1	3.0

Note: Pair Consists of 2 Leathers and 2 Buttons.



Fig. 233



## WINDSHIELD ADJUSTERS

**FIG. 1179 - WINDSHIELD ADJUSTER**



**FIG. 1179**

**CONSTRUCTION:**

- \* CHROME PLATED BRASS AND ZINC ALLOY
- \* BLACK PLASTIC KNOB



**ORDERING INFORMATION**

Length Closed Inches	Length Open Inches	O.D. Tube Inches	Dealer Pkg. 5 Cards 1 Pc. per Card	OEM Bulk Pkg. 20 Pcs.	Screw Size	Ship Wt. Carton Lbs. DP/OEM Bulk
10	18	1/2	1179 DP1 CHR	1179 001 CHR	6	3.9/12.2
12	20	1/2	1179 DP2 CHR	1179 002 CHR	6	4.3/13.3

Spare Knob, Cat. No. 1117 DP BLK.

**FIG. 1180 - WINDSHIELD ADJUSTER**



**FIG. 1180**

**CONSTRUCTION:**

- \* CHROME PLATED BRASS AND ZINC ALLOY
- \* BLACK PLASTIC KNOB



**ORDERING INFORMATION**

Length Closed Inches	Length Open Inches	O.D. Tube Inches	Dealer Pkg. 5 Cards 1 Pc. per Card	OEM Bulk Pkg. 20 Pcs.	Screw Size	Ship Wt. Carton Lbs. DP/OEM Bulk
12	21	1/2	1180 DP CHR	1180 000 CHR	6	4.3/13.3

Spare Knob, Cat. No. 1117 DP BLK.

**FIG. 1116 - WINDSHIELD ADJUSTER**



**FIG. 1116**

**CONSTRUCTION:**

- \* CHROME PLATED BRASS AND ZINC ALLOY
- \* BLACK PLASTIC KNOB



**ORDERING INFORMATION**

Length Rod Inches	O.D. Rod Inches	Dealer Pkg. 5 Cards 1 Pc. per Card	OEM Bulk Pkg. 20 Pcs.	Screw Size	Ship Wt. Carton Lbs. DP/OEM Bulk
8	3/8	1116 DP1 CHR	1116 001 CHR	8	3.3/9.8
10	3/8	1116 DP2 CHR	1116 002 CHR	8	3.7/10.8
12	3/8	1116 DP3 CHR	1116 003 CHR	8	4.2/12.9

Spare Knob, Cat. No. 1117 DP BLK.



## WINDSHIELD ADJUSTERS

### FIGS. 1290 & 1291 - WINDSHIELD ADJUSTERS

**CONSTRUCTION:**

- \* CHROME PLATED ZINC ALLOY
- \* BLACK PLASTIC KNOB

**FIG. 1290 - SIDE MOUNT**

**FIG. 1291 - OFFSET MOUNT**

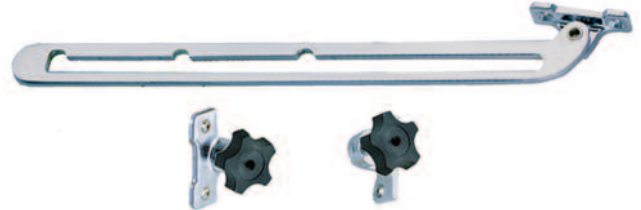

**FIG. 1290  
SIDE MOUNT**

**FIG. 1291  
OFFSET MOUNT**



### ORDERING INFORMATION

Length Overall Inches	Length Adjustment Inches	Dealer Pkg. 5 Cards 1 Pair per Card	OEM Bulk Pkg. 10 Pair	Screw Size	Ship Wt. Carton Lbs. DP/OEM Bulk
12	9-1/2	1290 DP CHR	1290 000 CHR	8	6.3/9.4
12	9-1/2	1291 DP CHR	1291 000 CHR	8	6.4/9.6

### SPARE PARTS ORDERING INFORMATION

Figure No.	Port Adjuster	Starboard Adjuster	Mounting Bracket With Knob	Knob Only
1290	1290 P00 99A	1290 S00 99A	1290 000 99B	1292 000 BLK
1291	1291 P00 99A	1291 S00 99A	1291 000 99B	1292 000 BLK

NOTE: Illustration is Port Side.

### FIG. 82 - WINDSHIELD ADJUSTER

**CONSTRUCTION:**

- \* CHROME PLATED BRASS AND BRONZE
- \* BLACK PLASTIC KNOB

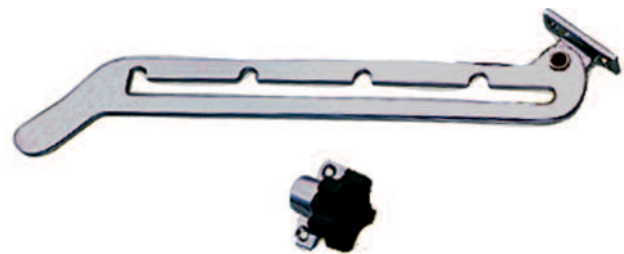

**FIG. 82**

### ORDERING INFORMATION

Length Overall Inches	Length Adjustment Inches	Standard Pkg. - 1 Pair	Screw Size	Ship Wt. Carton Lbs. Std. Pkg
12	9-1/2	82 000 CHR	8	2.5

Spare Port Adjuster, Cat. No. 82 P00 99B.  
Spare Starboard Adjuster, Cat. No. 82 S00 99B.  
Spare Knob, Cat. No. 82 000 99A.

NOTE: Illustration is Port Side.

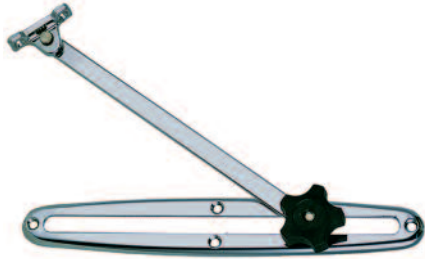

FIG. 797

FIG. 797 - HATCH ADJUSTER

**CONSTRUCTION:**

- \* CHROME PLATED BRASS AND ZINC ALLOY
- \* BLACK PLASTIC KNOB



**ORDERING INFORMATION**

Length Arm Inches	Length Adjustment Inches	Length Slide Inches	Dealer Pkg. 5 Cards 1 Pc. per Card	Screw Size	Ship Wt. Carton Lbs. Dealer Pkg.
10	9-1/2	10-3/4	797 DP CHR	8	4.4

FIG. 762 - HATCH SUPPORT BRACES



FIG. 762

**CONSTRUCTION:**

- \* CHROME PLATED BRASS



**ORDERING INFORMATION**

Length Open Inches	Dealer Pkg. - 5 Cards 1 Pair per Card	OEM Bulk Pkg. 20 Pair	Screw Size	Ship Wt. Carton Lbs. DP/OEM Bulk
10	762 DP1 CHR	762 001 CHR	8	4.1/13.9
12	762 DP2 CHR	762 002 CHR	8	4.4/15.5
14	762 DP3 CHR	762 003 CHR	8	5.2/17.2

NOTE: Illustration is Port Side.

FIG. 155 - HATCH FASTENER OR WINDSHIELD KEEPER



FIG. 155

**CONSTRUCTION:**

- \* CHROME PLATED BRASS AND ZINC ALLOY
- \* PHOSPHOR BRONZE SPRING



**ORDERING INFORMATION**

Length Overall Inches	Dimensions Mounting Base Inches	Dealer Pkg. 5 Cards 1 Pc. per Card	OEM Bulk Pkg. 50 Pcs.	Screw Size	Ship Wt. Carton Lbs. DP/OEM Bulk
3-7/8	1-1/2 x 9/16	155 DP CHR	155 000 CHR	6	1.4/10.4

## HATCH FASTENERS OR WINDSHIELD KEEPERS

**FIG. 769 - HATCH FASTENER OR WINDSHIELD KEEPER**

**CONSTRUCTION:**

- \* CHROME PLATED BRASS AND ZINC ALLOY
- \* BLACK PLASTIC HANDLE



**ORDERING INFORMATION**

Dimensions	Dealer Pkg.	OEM	Screw	Ship Wt.
Base	5 Cards	Bulk Pkg.	Size	Carton Lbs.
Inches	1 Pc. per Card	25 Pcs.		DP/OEM Bulk
1-1/2 x 5/8	769 DP CHR	769 000 CHR	8	1.6/5.9

Spare Keeper, Cat. No. 769 000 99A.  
Spare Handle with Stud, Cat. No. 769 000 99C.



**FIG. 769**

**FIG. 697 - HATCH FASTENER OR WINDSHIELD KEEPER**

**CONSTRUCTION:**

- \* CHROME PLATED BRASS AND ZINC ALLOY



**ORDERING INFORMATION**

Length	Dimensions	Dimensions	Dealer Pkg.	Screw	Ship Wt.
Bolt	Bracket	Keeper	10 Cards	Size	Carton Lbs.
Inches	Inches	Inches	1 Pc. per Card		Dealer Pkg.
1-1/2	1-1/2 x 5/8	1-1/2 x 3/4	697 DP CHR	8	2.1



**FIG. 697**

**FIG. 967 - HATCH FASTENER OR WINDSHIELD KEEPER**

**CONSTRUCTION:**

- \* CHROME PLATED BRONZE



**ORDERING INFORMATION**

Length	Dimensions	Dimensions	Dealer Pkg.	OEM	Ship Wt.
Bolt	Bracket	Keeper	5 Cards	Bulk Pkg.	Carton Lbs.
Inches	Inches	Inches	1 Pc. per Card	25 Pcs	DP/OEM Bulk
1-1/2	1-9/16 x 1	1-7/8 x 7/8	967 DP CHR	967 000 CHR	8 1.4/5.9



**FIG. 967**

**FIG. 770 - HATCH FASTENER**

**CONSTRUCTION:**

- \* CHROME PLATED BRONZE
- \* BLACK PLASTIC KNOB



**ORDERING INFORMATION**

Dimensions	Adjustment	Dealer Pkg.	OEM	Screw	Ship Wt.
Overall	Thread	5 Cards	Bulk Pkg.	Size	Carton Lbs.
Inches	Inches	1 Pc. per Card	25 Pcs.		DP/OEM Bulk
3-1/2 x 1-5/8	7/8	770 DP CHR	770 000 CHR	8	2.4/9.7



**FIG. 770**

## HOLD-DOWN CLAMPS

**FIG. 1112 - HOLD-DOWN CLAMP**



**FIG. 1112**

**CONSTRUCTION:**

- \* **CHROME PLATED BRONZE**
- \* **FLAT MOUNTING**



**ORDERING INFORMATION**

Length Inches	Width Inches	Dealer Pkg. - 5 Cards 1 Pc. per Card	OEM Bulk Pkg. 25 Pcs.	Screw Size	Ship Wt. Carton Lbs. DP/OEM Bulk
3	1-1/2	1112 DP CHR	1112 000 CHR	8	2.3/8.9

**FIG. 1113 - HOLD-DOWN CLAMP**



**FIG. 1113**

**CONSTRUCTION:**

- \* **CHROME PLATED BRONZE**
- \* **RIGHT ANGLE MOUNTING**



**ORDERING INFORMATION**

Length Inches	Width Inches	Dealer Pkg. - 5 Cards 1 Pc. per Card	OEM Bulk Pkg. 25 Pcs.	Screw Size	Ship Wt. Carton Lbs. DP/OEM Bulk
2-1/2	1-1/2	1113 DP CHR	1113 000 CHR	8	2.3/9.3

**FIG. 1108 - LOCKABLE HOLD-DOWN CLAMP**



**FIG. 1108**

**CONSTRUCTION:**

- \* **CHROME PLATED BRONZE**
- \* **FLAT MOUNTING**



**ORDERING INFORMATION**

Dimensions Base Inches	Clearance Padlock Inches	Dealer Pkg. 5 Cards 1 Pc. per Card	OEM Bulk Pkg. 25 Pcs.	Screw Size	Ship Wt. Carton Lbs. DP/OEM Bulk
2-3/4 x 1-3/4	1/4	1108 DP CHR	1108 000 CHR	6	2.1/8.4

## PULL APART HINGES, HATCH TRIM & CONTINUOUS HINGE

**FIGS. 149 & 152 - PULL APART HINGES**

**CONSTRUCTION:**

\* **CHROME PLATED BRONZE**

**FIG. 149 - LEFT HAND**

**FIG. 152 - RIGHT HAND**

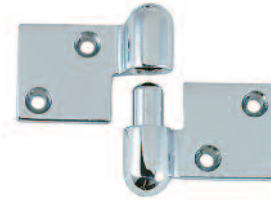

**FIG. 152  
RIGHT HAND**

Use 2 Left Hand or 2 Right Hand For Quick Removal of Hatches, Motor Covers, etc.  
or Together (1 each Left & Right) as a Heavy Duty Hinge Set.



**ORDERING INFORMATION**

Length Open Inches	Width Overall Inches	Dealer Pkg. 5 Cards 1 Pc. per Card	OEM Bulk Pkg. Pkg. - 25 Pcs.	Screw Size	Ship Wt. Carton Lbs. DP/OEM Bulk
3-3/4	2	149 DP CHR	149 000 CHR	10	2.0/8.9
3-3/4	2	152 DP CHR	152 000 CHR	10	2.0/8.9



**FIG. 149  
LEFT HAND**

**FIG. 258 - HATCH TRIM**

**CONSTRUCTION:**

\* **POLISHED STAINLESS STEEL**



**FIG. 258**

**ORDERING INFORMATION**

Width Inches	Length Overall Inches	Standard Pkg. - 10 Pcs.	Screw Size	Ship Wt. Carton Lbs. Std. Pkg.
1-1/4	72	258 002 STS	6	11.0
1-1/2	72	258 004 STS	6	12.7



**FIG. 212 - CONTINUOUS HINGE**

**CONSTRUCTION:**

- \* **POLISHED STAINLESS STEEL**
- \* **COUNTERSUNK HOLES ARE TWO INCHES APART, CENTER TO CENTER**

**IMPROVED  
Packaging**



**New DP Package**



**FIG. 212**



**ORDERING INFORMATION**

Width Open Inches	Dealer Pkg. 5 Pcs. One 24" Lgth/Card	Standard Pkg. 10 Pcs. per Tube in 72" Lengths	Screw Size	Ship Wt. Carton Lbs. DP/Std. Pkg.
1-1/4	212 DP2 STS	212 002 STS	5	3.5/15.9
1-1/2	212 DP4 STS	212 004 STS	5	3.8/18.0



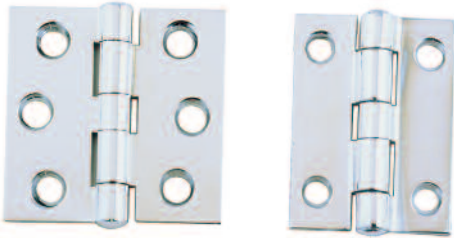

**Fig. 1002**

**FIG. 1002 - BUTT HINGE**

**CONSTRUCTION:**

- \* **HEAVY GAUGE EXTRUDED BRASS**
- \* **CHROME PLATED**
- \* **FAST PIN**



**ORDERING INFORMATION**

Height Pin Inches	Width Open Inches	Dealer Pkg. 1 Pair per Card	Cards per Pkg.	Standard Pkg. Catalog No.	Std. Pkg. Pair	Screw Size	No. of Holes	Ship Wt. Carton Lbs. DP/Std. Pkg.
2	1-1/2	1002 003 DP	5	1002 003 CHR	5	6	4	1.2/1.4
2	2	1002 004 DP	5	1002 004 CHR	5	6	6	1.3/1.6
3	2	1002 007 DP	5	1002 007 CHR	5	8	6	2.3/9.7
3	3	1002 009 DP	1	1002 009 CHR	5	10	6	1.2/8.9
4	3	1002 012 DP	1	1002 012 CHR	1	10	6	1.2/1.5
4	4	1002 013 DP	1	1002 013 CHR	1	1/4	6	2.0/8.7
5	4	-----	---	1002 014 CHR	1	1/4	8	--/2.1



**Fig. 1004**

**FIG. 1004 - BUTT HINGE**

**CONSTRUCTION:**

- \* **CHROME PLATED EXTRUDED BRASS**
- \* **EXTRA HEAVY DUTY, PLASTIC BEARINGS**
- \* **REMOVABLE PIN**

For Transom Doors and Other Applications  
Where Extra Strength and Smooth Operation are Required.



**ORDERING INFORMATION**

Height Pin Inches	Width Open Inches	Dealer Pkg. 1 Card 1 Pair per Card	OEM Bulk Pkg. 1 Pair	Screw Size	No. of Holes	Ship Wt. Carton Lbs. DP/OEM Bulk
4	4	1004 DP CHR	1004 000 CHR	1/4	6	2.0/1.7

## HINGES

**FIG. 952 - BUTT HINGE**

**CONSTRUCTION:**

- \* **HEAVY GAUGE STAMPED BRASS**
- \* **CHROME PLATED**
- \* **REMOVABLE PIN**



**ORDERING INFORMATION**

Height Pin Inches	Width Open Inches	Chrome Plated Brass Dealer Pkg. - 5 Cards 1 Pair per Card	Chrome Plated Brass OEM Bulk Pkg. 25 Pair	Screw Size	No. of Holes	Ship Wt. Carton Lbs. DP/OEM Bulk
1-1/2	1-1/4	952 DP1 CHR	-----	6	4	0.8/--
1-1/2	1-1/2	952 DP2 CHR	-----	6	4	0.8/--
2	1-1/2	952 DP3 CHR	-----	6	4	1.1/--
2	2	952 DP4 CHR	952 004 CHR	6	6	1.4/5.1
2-1/2	2	952 DP5 CHR	952 005 CHR	8	6	1.6/6.5
2-1/2	2-1/2	952 DP6 CHR	-----	8	6	1.8/--
3	3	952 DP9 CHR	952 009 CHR	10	6	3.7/16.4



**FIG. 952**

**FIG. 941 - BUTT HINGE**

**CONSTRUCTION:**

- \* **CHROME PLATED ZINC ALLOY**



**ORDERING INFORMATION**

Height Pin Inches	Width Open Inches	Dealer Pkg. 5 Cards 1 Pair per Card	OEM Bulk Pkg. 50 Pair	Screw Size	Ship Wt. Carton Lbs. DP/OEM Bulk
1-1/2	1-1/2	941 DP CHR	941 000 CHR	8	1.1/8.9



**FIG. 941**

**FIG. 951 - HINGE**

**CONSTRUCTION:**

- \* **CHROME PLATED BRONZE**



**ORDERING INFORMATION**

Width Open Inches	Height Pin Inches	Dealer Pkg. 5 Cards 1 Pair per Card	OEM Bulk Pkg. 25 Pair	Screw Size	Ship Wt. Carton Lbs. DP/OEM Bulk
3	1-1/2	951 DP1 CHR	951 001 CHR	8	1.7/7.5
4	1-1/2	951 DP2 CHR	951 002 CHR	8	1.9/8.1



**FIG. 951**

## BUTT HINGES



**FIG. 1293**

**FIG. 1293 - BUTT HINGE**

- CONSTRUCTION:**
- \* CHROME PLATED ZINC ALLOY
  - \* REMOVABLE PIN



### ORDERING INFORMATION

Height Pin Inches	Width Open Inches	Dealer Pkg. 5 Cards 1 Pair per Card	OEM Bulk Pkg. 25 Pair	Screw Size	No. of Holes	Ship Wt. Carton Lbs. DP/OEM Bulk
1-1/2	1-1/2	1293 DP2 CHR	-----	8	4	0.9/--
2	1-1/2	1293 DP3 CHR	-----	8	4	1.3/--
2	2	1293 DP4 CHR	1293 004 CHR*	8	4	1.6/13.0
2-1/2	2	1293 DP5 CHR	1293 005 CHR	8	6	1.9/8.4
2-1/2	2-1/2	1293 DP6 CHR	1293 006 CHR	8	6	2.0/8.6
3	3	1293 DP9 CHR	1293 009 CHR	10	6	3.0/12.5

\* OEM Bulk Pkg. - 50 Pair.

**FIG. 949 - BUTT HINGE**

- CONSTRUCTION:**
- \* HEAVY GAUGE STAMPED BRASS
  - \* CHROME PLATED
  - \* FAST PIN



**FIG. 949**



### ORDERING INFORMATION

Height Pin Inches	Width Open Inches	Dealer Pkg. 5 Cards 1 Pair per Card	OEM Bulk Pkg. 25 Pair	Screw Size	No. of Holes	Ship Wt. Carton Lbs. DP/OEM Bulk
1-1/2	1-1/4	949 DP1 CHR	-----	6	4	0.8/--
1-1/2	1-1/2	949 DP2 CHR	-----	6	4	0.8/--
2	1-1/2	949 DP3 CHR	-----	6	4	1.1/--
2	2	949 DP4 CHR	949 004 CHR	6	6	1.3/5.2
2-1/2	2	949 DP5 CHR	949 005 CHR	8	6	1.6/6.4
2-1/2	2-1/2	949 DP6 CHR	949 006 CHR	8	6	1.8/7.2
3	3	949 DP9 CHR	949 009 CHR	10	6	3.8/16.5



## HINGES

### FIG. 808 - HINGE

**CONSTRUCTION:**

\* **CHROME PLATED ZINC ALLOY**



**ORDERING INFORMATION**

Width Open Inches	Height Pin Inches	Dealer Pkg. 10 Cards 1 Pair per Card	OEM Bulk Pkg. 50 Pair	Screw Size	Ship Wt. Carton Lbs. DP/OEM Bulk
3	1-1/2	808 DP CHR	808 000 CHR	8	3.5/16.6



**FIG. 808**

### FIGS. 987 & 1213 - SHORTSIDE HINGES

**CONSTRUCTION OPTIONS:**

**FIG. 987 - CHROME PLATED BRONZE**

**FIG. 1213 - CHROME PLATED ZINC ALLOY**



**ORDERING INFORMATION**

Width Open Inches	Height Pin Inches	Width Shortside Inches	Dealer Pkg. 5 Cards 1 Pair per Card	OEM Bulk Pkg. 50 Pair	Screw Size	Ship Wt. Carton Lbs. DP/OEM Bulk
2-1/4	1-1/2	3/4	987 DP1 CHR	987 001 CHR	8	1.5/13.3
2-3/4	1-1/2	3/4	987 DP2 CHR	-----	8	1.6/--
2-1/2	1-1/2	3/4	1213 DP1 CHR	1213 001 CHR	8	1.4/12.7



**FIG. 987**

**CHROME PLATED BRONZE**

**FIG. 1213**

**CHROME PLATED ZINC ALLOY**

### FIGS. 988 & 1214 - OFFSET SHORTSIDE HINGES

**CONSTRUCTION OPTIONS:**

**FIG. 988 - CHROME PLATED BRONZE**

**FIG. 1214 - CHROME PLATED ZINC ALLOY**



**ORDERING INFORMATION**

Width Open Inches	Height Pin Inches	Width Shortside Inches	Offset Inches	Dealer Pkg. 5 Cards 1 Pair per Card	Screw Size	Ship Wt. Carton Lbs. Dealer Pkg.
2-1/4	1-1/2	3/4	3/8	988 DP1 CHR	8	1.5
2-3/4	1-1/2	3/4	3/8	988 DP2 CHR	8	1.7
2-1/2	1-1/2	3/4	3/8	1214 DP1 CHR	8	1.6



**FIG. 988**

**CHROME PLATED BRONZE**

**FIG. 1214**

**CHROME PLATED ZINC ALLOY**

### FIG. 999 - SHORTSIDE HINGE

**CONSTRUCTION:**

\* **CHROME PLATED BRONZE**



**ORDERING INFORMATION**

Width Open Inches	Height Pin Inches	Width Shortside Inches	Dealer Pkg. 5 Cards 1 Pair per Card	Screw Size	Ship Wt. Carton Lbs. Dealer Pkg.
3-1/2	1-1/2	1-1/2	999 DP CHR	8	1.8



**FIG. 999**

**FIG. 942 - OFFSET HINGE**



**FIG. 942**

**CONSTRUCTION:**

- \* CHROME PLATED ZINC ALLOY



**ORDERING INFORMATION**

Width Open Inches	Height Pin Inches	Offset Inches	Dealer Pkg. 5 Cards 1 Pair per Card	OEM Bulk Pkg. 50 Pair	Screw Size	Ship Wt. Carton Lbs. DP/OEM Bulk
1-1/2	1-1/2	3/8	942 DP CHR	942 000 CHR	8	1.2/10.5

**FIG. 271 - INSET HINGE**



**FIG. 271**

**CONSTRUCTION:**

- \* SEMI-CONCEALED
- \* FOR INSET DOORS
- \* CHROME PLATED STAMPED BRASS
- \* 3/8 INCH INSET



**ORDERING INFORMATION**

Dimensions Inches	Dealer Pkg. 10 Cards 1 Pair per Card	OEM Bulk Pkg. 100 Pair	Screw Size	Ship Wt. Carton Lbs. DP/OEM Bulk
2-3/4 x 2-1/8	271 DP CHR	271 000 CHR	4	2.1/17.2

**FIG. 272 - FLUSH HINGE**



**FIG. 272**

**CONSTRUCTION:**

- \* SEMI-CONCEALED
- \* FOR OVERLAY DOORS
- \* CHROME PLATED STAMPED BRASS



**ORDERING INFORMATION**

Dimensions Inches	Dealer Pkg. 10 Cards 1 Pair per Card	OEM Bulk Pkg. 100 Pair	Screw Size	Ship Wt. Carton Lbs. DP/OEM Bulk
2-3/4 x 2-1/8	272 DP CHR	272 000 CHR	4	1.8/14.7

## HINGES

**FIG. 120 - STRAP HINGE**

**CONSTRUCTION:**

\* **CHROME PLATED BRONZE**



**ORDERING INFORMATION**

Width Open Inches	Height Pin Inches	Dealer Pkg. 5 Cards 1 Pair per Card	Screw Size	No. of Holes	Ship Wt. Carton Lbs. Dealer Pkg.
4	1-1/8	120 DP1 CHR	10	4	2.2
6	1-1/8	120 DP2 CHR	10	6	2.8
8	1-3/8	120 DP3 CHR	12	6	5.1



**FIG. 120**

**FIG. 197 - "T" HINGE**

**CONSTRUCTION:**

\* **CHROME PLATED BRONZE**



**ORDERING INFORMATION**

Width Open Inches	Height Overall Inches	Width "T" Side Inches	Dealer Pkg. 5 Cards 1 Pair per Card	Screw Size	No. of Holes	Ship Wt. Carton Lbs. Dealer Pkg.
4	2-1/8	1-5/16	197 DP1 CHR	10	6	2.8
6	3	1-1/2	197 DP2 CHR	10	7	4.8
8	3-7/8	2	197 DP3 CHR*	12	8	3.4



**FIG. 197**

\* Dealer Pkg. - 2 Cards, 1 Pair per Card.

**FIG. 924 - HINGE**

**CONSTRUCTION:**

\* **CHROME PLATED STAMPED BRASS**



**ORDERING INFORMATION**

Width Open Inches	Height Pin Inches	Dealer Pkg. 10 Cards 1 Pair per Card	Screw Size	Ship Wt. Carton Lbs. Dealer Pkg.
3	1-1/2	924 DP CHR	6	2.0

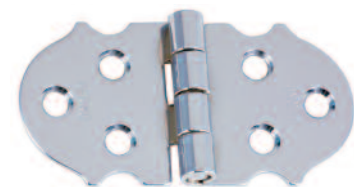

**FIG. 924**

**FIG. 957 - NON-MORTISED HINGE**

**CONSTRUCTION:**

\* **CHROME PLATED STAMPED BRASS**

\* **EASILY INSTALLS WITHOUT MORTISING**



**ORDERING INFORMATION**

Height Pin Inches	Width Closed Inches	Dealer Pkg. 5 Cards 1 Pair per Card	OEM Bulk Pkg. 50 Pair	Screw Size	Ship Wt. Carton Lbs. DP/OEM Bulk
3-3/8	7/8	957 DP CHR	957 000 CHR	8	1.5/12.2



**FIG. 957**



**FIG. 998**

**FIG. 998 - HASP**

**CONSTRUCTION:**

\* **CHROME PLATED BRONZE**



**ORDERING INFORMATION**

Length Closed Inches	Width Overall Inches	Padlock Clearance Inches	Dealer Pkg. 10 Cards 1 Pc. per Card	OEM Bulk Pkg. 25 Pcs.	Screw Size	Ship Wt. Carton Lbs. DP/OEM Bulk
2	1	9/32	998 DP1 CHR	998 001 CHR	6	2.0/3.7
3	1	9/32	998 DP2 CHR	998 002 CHR	6	2.8/4.7

Spare Chrome Keepers (2 per card), Cat. No. 959 DP CHR.



**FIG. 1198**

**FIG. 1198 - HASP**

**CONSTRUCTION:**

\* **CHROME PLATED ZINC ALLOY**



**ORDERING INFORMATION**

Length Closed Inches	Width Inches	Padlock Clearance Inches	Dealer Pkg. 10 Cards 1 Pc. per Card	OEM Bulk Pkg. 25 Pcs.	Screw Size	Ship Wt. Carton Lbs. DP/OEM Bulk
2	1	1/4	1198 DP1 CHR	1198 001 CHR	6	1.6/2.8
3	1	1/4	1198 DP2 CHR	1198 002 CHR	6	1.8/3.4
3-3/4	1	1/4	1198 DP3 CHR	1198 003 CHR	6	2.0/3.9

Spare Keepers (2 per card), Cat. No. 1261 DP CHR.

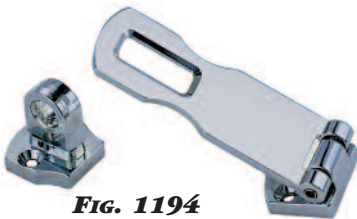

**FIG. 1194**

**FIG. 1194 - SWIVEL EYE HASP**

**CONSTRUCTION:**

\* **CHROME PLATED ZINC ALLOY**  
\* **PADLOCK EYE SWIVELS TO ACT AS A LATCH**



**ORDERING INFORMATION**

Length Closed Inches	Width Inches	Padlock Clearance Inches	Dealer Pkg. 10 Cards 1 Pc. per Card	OEM Bulk Pkg. 50 Pcs.	Screw Size	Ship Wt. Carton Lbs. DP/OEM Bulk
3	1	11/32	1194 DP CHR	1194 000 CHR	6	2.0/7.6

Spare Keeper (1 per card), Cat. No. 1194 DP 99A.

## BARREL BOLTS & SHIP BOLT

**FIG. 1244 - BARREL BOLT**

**CONSTRUCTION:**

- \* **CHROME PLATED ZINC ALLOY**
- INTEGRAL FRICTION PAD ELIMINATES RATTLE**
- AND PROVIDES SMOOTH OPERATION**



**ORDERING INFORMATION**

Dimensions Overall Inches	Dealer Pkg. - 5 Cards 1 Pc. per Card	OEM Bulk Pkg. 25 Pcs.	Screw Size	Ship Wt. Carton Lbs. DP/OEM Bulk
3-3/8 x 1-1/4	1244 DP CHR	1244 000 CHR	6 R.H.	1.1/4.4

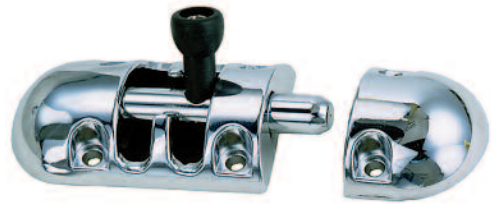

**FIG. 1244**

**FIG. 947 - BARREL BOLT**

**CONSTRUCTION:**

- \* **CHROME PLATED BRONZE BODY & KEEPER**
- \* **3/8" DIAMETER BOLT**
- \* **INCLUDES HIGH IMPACT BLACK NYLON BULKHEAD KEEPER**
- \* **KEEPER EASILY INSTALLS IN A 5/8" HOLE**
- \* **SUPPLIED WITH FRICTION PAD TO ELIMINATE RATTLE AND PROVIDE SMOOTH OPERATION**

**DEALER PACKAGE INCLUDES BOTH STYLES OF KEEPERS**  
**BULK PACKAGE INCLUDES ONLY ONE STYLE OF KEEPER**

STANDARD KEEPER ORDER EXAMPLE: 947 001 CHR  
 BULKHEAD KEEPER ORDER EXAMPLE: 947 B01 CHR



**ORDERING INFORMATION**

Dimensions Overall Inches	Dealer Pkg. - 5 Cards 1 Pc. per Card	OEM Bulk Pkg. 25 Pcs.	Screw Size	Ship Wt. Carton Lbs. DP/OEM Bulk
3-7/16 x 1-7/16	947 DP1 CHR	947 001 CHR	6	1.7/7.1
4-5/16 x 1-7/16	947 DP2 CHR	947 002 CHR	6	2.1/9.1
5-1/4 x 1-7/16	947 DP3 CHR	947 003 CHR	6	2.4/10.6
3-7/16 x 1-7/16	-----	947 B01 CHR	6	7.1
4-5/16 x 1-7/16	-----	947 B02 CHR	6	9.1
5-1/4 x 1-7/16	-----	947 B03 CHR	6	10.6

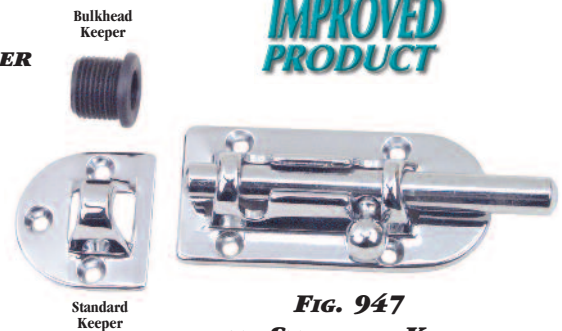

**FIG. 947**  
**WITH STANDARD KEEPER**  
**AND BULKHEAD KEEPER**

**FIG. 1053 - SHIP BOLT**

**CONSTRUCTION:**

- \* **CHROME PLATED BRONZE**
- SUPPLIED WITH BRASS FRICTION SPRING TO ELIMINATE RATTLE AND PROVIDE DETENTED OPERATION**



**ORDERING INFORMATION**

Dimensions Overall Inches	Dealer Pkg. - 5 Cards 1 Pc. per Card	OEM Bulk Pkg. 25 Pcs.	Screw Size	Ship Wt. Carton Lbs. DP/OEM Bulk
2-5/8 x 1-1/4	1053 DP CHR	1053 000 CHR	6	0.9/3.9

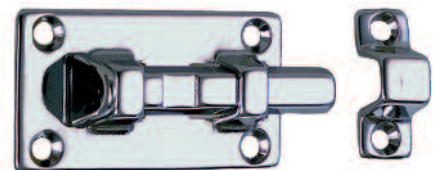

**FIG. 1053**

## CABIN DOOR HOOKS



**FIG. 956**

**FIG. 956 - CABIN DOOR HOOK**

**CONSTRUCTION OPTIONS:**

**\* CAST BRONZE  
PLAIN OR CHROME PLATED**



**ORDERING INFORMATION**

Length Hook Inches	Chrome Plated Bronze Dealer Pkg. - 5 Cards 1 Pc. per Card	Chrome Plated Bronze OEM Bulk Pkg. 50 Pcs.	Plain Bronze Standard Pkg. - 5 Pcs.	Ship Wt. Carton Lbs. DP/OEM Bulk/Std.Pkg
1-1/2	956 DP1 CHR	956 001 CHR	956 001 PLB	0.9/5.3/0.6
2	956 DP2 CHR	956 002 CHR	956 002 PLB	0.9/5.6/0.7
2-1/2	956 DP3 CHR	956 003 CHR	956 003 PLB	0.9/6.0/0.7
3	956 DP4 CHR	956 004 CHR	956 004 PLB	1.0/7.2/0.8
3-1/2	956 DP5 CHR	-----	956 005 PLB	1.0/--/0.8
4	956 DP6 CHR	-----	956 006 PLB	1.1/--/0.9
5	956 DP7 CHR	-----	956 007 PLB	1.2/--/1.0
6	956 DP8 CHR	*956 008 CHR	956 008 PLB	1.5/7.5/1.2

\*O.E.M. Bulk Pkg. - 25 pcs.

Screw Size #6.

Spare Plain Keepers (2 per card), Cat. No. 959 DP PLB.

Spare Chrome Keepers (2 per card), Cat. No. 959 DP CHR.

Spare Chrome Keepers O.E.M Bulk (100 pcs.) Cat. No. 959 000 CHR.

**FIG. 959  
SPARE KEEPER**



**FIG. 1199 - CABIN DOOR HOOK**

**CONSTRUCTION:**

**\* CHROME PLATED ZINC ALLOY**



**ORDERING INFORMATION**

Length Hook Inches	Dealer Pkg. 20 Cards 1 Pc. per Card	OEM Bulk Pkg. 50 Pcs.	Screw Size	Ship Wt. Carton Lbs. DP/OEM Bulk
1-3/4	1199 DP1 CHR	1199 001 CHR	6	2.6/4.6
2-1/4	1199 DP2 CHR	1199 002 CHR	6	2.7/4.9
3	1199 DP3 CHR	1199 003 CHR	6	3.1/5.7
4	1199 DP4 CHR	1199 004 CHR	6	3.4/6.3

Spare Keepers (2 per card), Cat. No. 1261 DP CHR.

**FIG. 1199**

**FIG. 1261  
SPARE KEEPER**



**FIG. 1287 - CABIN DOOR HOOK**

**CONSTRUCTION:**

**\* CHROME PLATED ZINC ALLOY**



**ORDERING INFORMATION**

Length Hook Inches	Dealer Pkg. 20 Cards 1 Pc. per Card	OEM Bulk Pkg. 50 Pcs.	Screw Size	Ship Wt. Carton Lbs. DP/OEM Bulk
2	1287 DP1 CHR	1287 001 CHR	6	2.8/5.1
2-1/2	1287 DP2 CHR	1287 002 CHR	6	3.1/5.6
3	1287 DP3 CHR	1287 003 CHR	6	3.1/5.8

Spare Keepers (2 per card), Cat. No. 1261 DP CHR.

**FIG. 1287**

**FIG. 1261  
SPARE KEEPER**



## DOOR STOPS & HOLDERS

**FIG. 574 - DOOR STOP AND HOLDER**

**CONSTRUCTION:**

- \* **CHROME PLATED BRONZE**
- \* **RUBBER BUMPER**



**ORDERING INFORMATION**

Length Inches	O.D. Inches	Dealer Pkg. 5 Cards 1 Pc. per Card	OEM Bulk Pkg. 25 Pcs.	Stop Screw Size	Keeper Screw Size	Ship Wt. Carton Lbs. DP/OEM Bulk
2-3/8	1-3/4	574 DP1 CHR	574 001 CHR	8	6	1.6/5.3
3-1/4	1-3/4	574 DP2 CHR	574 002 CHR	8	6	1.7/6.1



**FIG. 574**

**FIG. 1177 - DOOR STOP**

**CONSTRUCTION:**

- \* **CHROME PLATED ZINC ALLOY**
- \* **RUBBER BUMPER**



**ORDERING INFORMATION**

Length Inches	O.D. Inches	Dealer Pkg. 5 Cards 1 Pc. per Card	OEM Bulk Pkg. 50 Pcs.	Screw Size	Ship Wt. Carton Lbs. DP/OEM Bulk
1	1-1/4	1177 DP CHR	1177 000 CHR	4	0.5/2.8



**FIG. 1177**

**FIG. 1065 - DOOR HOLDER**

**CONSTRUCTION:**

- \* **STAINLESS STEEL CLIP**
- \* **CHROME PLATED ZINC ALLOY ARROW**



**ORDERING INFORMATION**

Dimensions Arrow Base Inches	Dimensions Clip Base Inches	Projection Inches	Dealer Pkg. 5 Cards 1 Pc. per Card	Screw Size	Ship Wt. Carton Lbs. Dealer Pkg.
1-5/8 x 3/4	1-3/8 x 7/16	1-3/4	1065 DP CHR	8	0.8

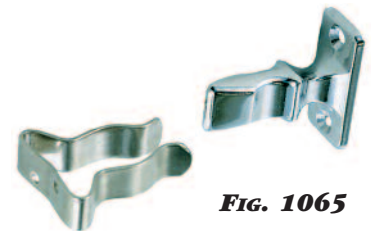

**FIG. 1065**



Fig. 554

Fig. 554 - DOOR CATCH

**CONSTRUCTION:**

- \* WHITE PLASTIC
- \* STAINLESS STEEL MOUNTING & KEEPER SCREWS



**ORDERING INFORMATION**

Screw Size Inches	Dimensions Catch Inches	Dealer Pkg. 25 Cards 2 Pcs. per Card	OEM Bulk Pkg. 100 Pcs.	Mounting Screw Size	Ship Wt. Carton Lbs. DP/OEM Bulk
3/4 x #8	1-1/4 x 5/8	554 DP	554	4 R.H.	1.7/2.6



Fig. 559

Fig. 559 - DOOR CATCH

**CONSTRUCTION:**

- \* BLACK PLASTIC



**ORDERING INFORMATION**

Dimensions Stud Inches	Dimensions Catch Inches	Dealer Pkg. 25 Cards 2 Pcs. per Card	OEM Bulk Pkg. 100 Pcs.	Screw Size	Ship Wt. Carton Lbs. DP/OEM Bulk
1-1/8 x 3/8	1-3/8 x 7/8	559 DP	559	4 R.H.	1.1/1.0



Figs. 1216 & 1217 - DOOR BUTTONS

**CONSTRUCTION:**

- \* CHROME PLATED ZINC ALLOY
- \* BLACK PLASTIC BUTTON

Fig. 1216 - Supplied with Phosphor Bronze Tension Spring

Fig. 1217 - Supplied without Spring and Requires a No. 8 Oval-Head Pivot Screw



**ORDERING INFORMATION**

Type	O.D. Overall Inches	Dealer Pkg. 10 Cards 1 Pc. per Card	OEM Bulk Pkg. 50 Pcs.	Screw Size	Ship Wt. Carton Lbs. DP/OEM Bulk
With Spring	1-3/4	1216 DP CHR	1216 000 CHR	6	1.0/4.1
W/O Spring	1-3/4	1217 DP CHR	1217 000 CHR	6	1.04.0

Spare Button for Both, Cat. No. 1216 000 99A.



Fig. 1216



Fig. 1217





## LOCK & LATCH SETS



# GET THE LOCKS & LATCHES THAT LOOK & PERFORM AS WELL AS YOUR BOAT

**Get The "T-Handle"**  
Figs. 1091 & 1092

★ **VERSATILE**

OPEN OR CLOSED, THE "T" HANDLE LAYS FLAT IN MOST CAM POSITIONS

BLACK OR WHITE PLASTIC BODY, CHROME OR PLASTIC HANDLE



★ **RUGGED & EASY TO OPEN**

"T" HANDLE ACCOMMODATES THE LARGEST GLOVED HAND

★ **KEEPS LOCKERS DRY**

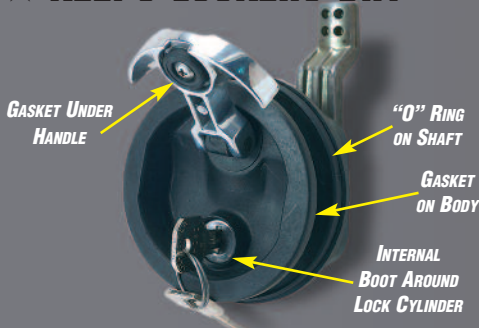

4 DIFFERENT SEALS PREVENT LEAKS

**Get The "Contemporary"**

Figs. 710, 711, 712 LATCHES AND Figs. 730 & 731 LOCKS

5 YEAR WARRANTY ON MECHANISM & FINISH

SILKY SMOOTH MECHANISM

GREAT FEEL



★ **MODERN STYLING**

TWO TONE ESCUTCHEON PLATES

PRIVACY LOCK MECHANISM ON BOTTOM

SAFETY UNLOCK FROM OUTSIDE ENTRY POINT

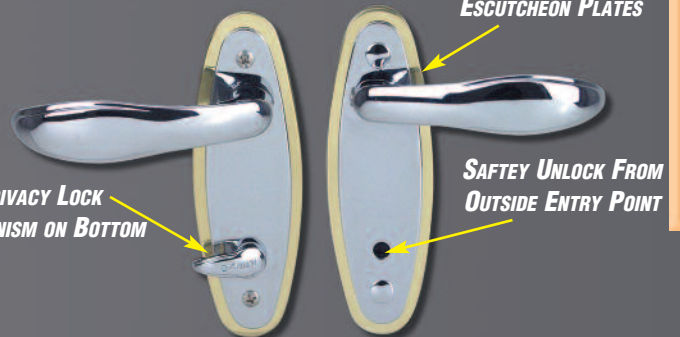

Cabinet Hardware

## "T" - HANDLE FLUSH LOCK & LATCH

**FIGS. 1091 & 1092 - FLUSH LOCK & LATCH FOR SMOOTH AND CARPETED SURFACES**  
 (GASKET INCLUDED FOR SMOOTH SURFACE APPLICATIONS)

**CONSTRUCTION OPTIONS:**

- \* BLACK OR WHITE PLASTIC BODY
- \* CHROME PLATED ZINC ALLOY, BLACK OR WHITE PLASTIC "T" HANDLE
- \* STAINLESS STEEL STEM

**FIG. 1091 #1**  
**BLK/CHR**



**FIG. 1091 - LOCK WITH 2 KEYS**  
**FIG. 1092 - LATCH (NON-LOCKING)**

- No. 1 with Offset Cam Bar
- No. 3 with Straight Cam Bar
- No. 4\* with Extra Long Offset Cam Bar
- No. 5\* with Extra Long Straight Cam Bar

Easily Installs in a 2-1/2 Inch Diameter Hole  
 For Mounting Surfaces 1/8 to 3/4 Inches Thick

**FIG. 1091 #1**  
**BLK/BLK**



**FIG. 1092 #3**  
**WHT/WHT**



**FIG. 1091 #4**  
**BLK/CHR**



**FIG. 1091 #5**  
**WHT/WHT**



**FIG. 1092 #4**  
**WHT/CHR**

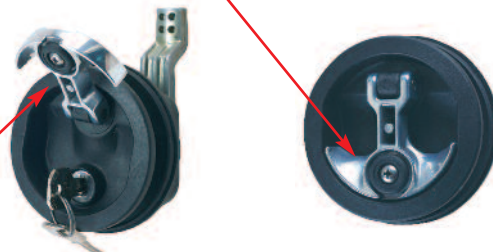

**FIG. 1092 #5**  
**WHT/WHT**



**THE T-HANDLE DROPS DOWN FLUSH IN EITHER THE OPEN OR CLOSED (180° ROTATION) POSITION**  
 (EXCEPT WITH THE OFFSET CAM BAR POSITIONED UPWARD).

**RUBBER SEAL**



**THE RUBBER SEAL & BOOT UNDER THE T-HANDLE SEALS THE LOCK CYLINDER PREVENTING WATER INTRUSION.**

## "T" - HANDLE FLUSH LOCK & LATCH AND FLUSH PULL



### ORDERING INFORMATION

Body Color	Handle Color	Type	Adjustment Cam Bar Inches	Dimensions Face Plate Inches	OEM Bulk Pkg. 25 Pcs.	Dealer Pkg. 5 Cards 1 Pc. per Card	Ship Wt. Carton Lbs. OEM Bulk/DP
Black	Chr. Plated	Lock	3/4 to 2-3/8	3" Dia.	1091 001 BLK	1091 DP1 BLK	15.5/4.1
Black	Chr. Plated	Lock	1-1/4 to 1-7/8	3" Dia.	1091 003 BLK	1091 DP3 BLK	15.7/4.2
Black	Chr. Plated	Lock	1/2 to 3	3" Dia.	1091 004 BLK	1091 DP4 BLK	17.4/4.4
Black	Chr. Plated	Lock	1-1/4 to 2	3" Dia.	1091 005 BLK	1091 DP5 BLK	17.4/4.1
Black	Chr. Plated	Latch	3/4 to 2-3/8	3" Dia.	1092 001 BLK	1092 DP1 BLK	13.7/3.7
Black	Chr. Plated	Latch	1-1/4 to 1-7/8	3" Dia.	1092 003 BLK	1092 DP3 BLK	13.9/3.6
Black	Chr. Plated	Latch	1/2 to 3	3" Dia.	1092 004 BLK	1092 DP4 BLK	14.3/4.0
Black	Chr. Plated	Latch	1-1/4 to 2	3" Dia.	1092 005 BLK	1092 DP5 BLK	14.3/3.8
White	Chr. Plated	Lock	3/4 to 2-3/8	3" Dia.	1091 001 WHT	1091 DP1 WHT	15.5/4.1
White	Chr. Plated	Lock	1-1/4 to 1-7/8	3" Dia.	1091 003 WHT	1091 DP3 WHT	15.7/3.9
White	Chr. Plated	Lock	1/2 to 3	3" Dia.	1091 004 WHT	1091 DP4 WHT	17.4/4.4
White	Chr. Plated	Lock	1-1/4 to 2	3" Dia.	1091 005 WHT	1091 DP5 WHT	17.4/4.1
White	Chr. Plated	Latch	3/4 to 2-3/8	3" Dia.	1092 001 WHT	1092 DP1 WHT	13.8/3.6
White	Chr. Plated	Latch	1-1/4 to 1-7/8	3" Dia.	1092 003 WHT	1092 DP3 WHT	13.9/3.6
White	Chr. Plated	Latch	1/2 to 3	3" Dia.	1092 004 WHT	1092 DP4 WHT	14.3/4.0
White	Chr. Plated	Latch	1-1/4 to 2	3" Dia.	1092 005 WHT	1092 DP5 WHT	14.3/3.8
Black	Black Plastic	Lock	3/4 to 2-3/8	3" Dia.	1091 B01 BLK	-----	12.5/--
Black	Black Plastic	Lock	1-1/4 to 1-7/8	3" Dia.	1091 B03 BLK	-----	13.0/--
Black	Black Plastic	Lock	1/2 to 3	3" Dia.	1091 B04 BLK	-----	14.9/--
Black	Black Plastic	Lock	1-1/4 to 2	3" Dia.	1091 B05 BLK	-----	14.9/--
Black	Black Plastic	Latch	3/4 to 2-3/8	3" Dia.	1092 B01 BLK	-----	11.1/--
Black	Black Plastic	Latch	1-1/4 to 1-7/8	3" Dia.	1092 B03 BLK	-----	11.4/--
Black	Black Plastic	Latch	1/2 to 3	3" Dia.	1092 B04 BLK	-----	12.0/--
Black	Black Plastic	Latch	1-1/4 to 2	3" Dia.	1092 B05 BLK	-----	12.0/--
White	White Plastic	Lock	3/4 to 2-3/8	3" Dia.	1091 W01 WHT	-----	12.8/--
White	White Plastic	Lock	1-1/4 to 1-7/8	3" Dia.	1091 W03 WHT	-----	13.8/--
White	White Plastic	Lock	1/2 to 3	3" Dia.	1091 W04 WHT	-----	14.9/--
White	White Plastic	Lock	1-1/4 to 2	3" Dia.	1091 W05 WHT	-----	14.9/--
White	White Plastic	Latch	3/4 to 2-3/8	3" Dia.	1092 W01 WHT	-----	12.5/--
White	White Plastic	Latch	1-1/4 to 1-7/8	3" Dia.	1092 W03 WHT	-----	13.0/--
White	White Plastic	Latch	1/2 to 3	3" Dia.	1092 W04 WHT	-----	12.0/--
White	White Plastic	Latch	1-1/4 to 2	3" Dia.	1092 W05 WHT	-----	12.0/--

Spare Offset Cam Bar, Cat. No.1091 001 99A.  
Spare Extra Long Offset Cam Bar, Cat. No.1091 004 99A.

Spare Straight Cam Bar, Cat. No. 1091 003 99A.  
Spare Extra Long Straight Cam Bar, Cat. No. 1091 005 99A.

**FIG. 1093 - "T" HANDLE FLUSH PULL  
FOR SMOOTH AND CARPETED SURFACES  
(GASKET INCLUDED FOR SMOOTH SURFACE APPLICATIONS)  
(TOOTHED BACK FOR CARPET SURFACE APPLICATIONS)**

**CONSTRUCTION OPTIONS:**

- \* **BLACK OR WHITE PLASTIC BODY**
- \* **CHROME PLATED ZINC ALLOY, BLACK OR WHITE PLASTIC "T" HANDLE**

- \* **STAINLESS STEEL STEM**

Easily Installs in a 2-1/2 Inch Diameter Hole  
For Mounting Surfaces 1/8 to 3/4 Inches Thick



**Fig. 1093**

### ORDERING INFORMATION

Color Body	Color Handle	Diameter Inches	OEM Bulk Pkg. 25 Pcs.	Ship Wt. Carton Lbs. OEM Bulk
Black	Black Plastic	3	1093 000 BLK	12.0
Black	Chrome Plated	3	1093 000 CHR	14.5
White	White Plastic	3	1093 000 WHT	12.0

## FLUSH LOCKS & LATCHES



**Fig. 931 #1 BLK**



**Fig. 932 #2 BLK**



**Fig. 931 #3 BLK**

**Figs. 931 & 1031 - FLUSH LOCKS WITH 2 KEYS**  
**Figs. 932 & 1032 - FLUSH LATCHES (NON-LOCKING)**

**CONSTRUCTION OPTIONS:**

- \* BLACK OR WHITE PLASTIC
- \* CHROME PLATED ZINC ALLOY
- \* STAINLESS STEEL STEM AND LOCK NUT

**Fig. 931/932**

No. 1 with Offset Cam Bar and Flexible Plastic Strike Plate  
 No. 2 with Offset Adjustable Cam Bar  
 No. 3 with Straight Cam Bar and Flexible Plastic Strike Plate  
 Detents Indicate Open or Closed Position. Easily Installs in a 2 Inch Diameter Hole. For Door Thickness 1/4 to 1-1/8 Inches

**Fig. 1031/1032**

- \* LARGE HANDLE ALLOWS TWO FINGER GRIP
- Flush Mounts in a 2-3/8 x 2-3/8 Inch Hole  
 Surface Mounts in a 1-5/8 Inch Diameter Hole  
 With Plastic Spacer Included  
 For Door Thickness 1/8 to 3/4 Inches

**Fig. 1031**



**Fig. 1032**

**FLEXIBLE  
 PLASTIC  
 STRIKE**



**ORDERING INFORMATION**

Finish	Type	Adjustment Cam Bar Inches	Dimensions Face Plate Inches	Dealer Pkg. 5 Cards 1 Pc. per Card	OEM Bulk Pkg. 25 Pcs.	Ship Wt. Carton Lbs. DP/OEM Bulk
Black	Lock	3/8 to 3	2-1/2 x 2-1/2	931 DP1 BLK	931 001 BLK	3.2/12.6
Black	Lock	3/8 to 3	2-1/2 x 2-1/2	931 DP2 BLK	931 002 BLK	3.2/12.7
Black	Lock	1-1/16 to 2-9/16	2-1/2 x 2-1/2	931 DP3 BLK	931 003 BLK	3.4/11.0
Black	Latch	3/8 to 3	2-1/2 x 2-1/2	932 DP1 BLK	932 001 BLK	2.9/11.2
Black	Latch	3/8 to 3	2-1/2 x 2-1/2	932 DP2 BLK	932 002 BLK	2.9/11.1
Black	Latch	1-1/16 to 2-9/16	2-1/2 x 2-1/2	932 DP3 BLK	932 003 BLK	3.1/11.8
White	Lock	3/8 to 3	2-1/2 x 2-1/2	931 DP1 WHT	931 001 WHT	3.2/12.8
White	Lock	3/8 to 3	2-1/2 x 2-1/2	931 DP2 WHT	931 002 WHT	3.2/12.7
White	Lock	1-1/16 to 2-9/16	2-1/2 x 2-1/2	931 DP3 WHT	931 003 WHT	3.4/13.6
White	Latch	3/8 to 3	2-1/2 x 2-1/2	932 DP1 WHT	932 001 WHT	3.0/11.0
White	Latch	3/8 to 3	2-1/2 x 2-1/2	932 DP2 WHT	932 002 WHT	2.8/11.2
White	Latch	1-1/16 to 2-9/16	2-1/2 x 2-1/2	932 DP3 WHT	932 003 WHT	3.1/11.9
Black	Lock	1/2 to 3	3-1/8 x 3-1/8	1031 DP1 BLK	1031 001 BLK	4.4/16.5
Black	Latch	1/2 to 3	3-1/8 x 3-1/8	1032 DP1 BLK	1032 001 BLK	3.9/15.4
White	Lock	1/2 to 3	3-1/8 x 3-1/8	1031 DP1 WHT	1031 001 WHT	4.4/16.5
White	Latch	1/2 to 3	3-1/8 x 3-1/8	1032 DP1 WHT	1032 001 WHT	3.9/15.4

Spare Offset Cam Bar, Cat. No. 931 001 99A.  
 Spare Straight Cam Bar, Cat. No. 931 003 99A.  
 Spare Offset Cam Bar For 1031/1032, Cat. No. 1091 004 99A.

Spare Offset Adjustable Cam Bar, Cat. No. 931 002 99A.  
 Flexible Plastic Strike Cat. No. 931 000 99B

**Fig. 1089 - LOCK & LATCH COVER**

**CONSTRUCTION OPTIONS:**

- \* BLACK OR WHITE FIBER REINFORCED PLASTIC. HINGED, WATER RESISTANT
- No. 1 - FITS Figs. 931/932, No. 3 - FITS Figs. 1031/1032**

**ORDERING INFORMATION**

Finish	Fits Fig. No.	Overall Dimensions	Dealer Pkg. - 5 Cards 1 Pc. per Card	OEM Bulk Pkg. 25 Pcs.	Ship Wt. Carton Lbs. DP/OEM Bulk
Black	931/932	2-3/4 x 3-1/4	1089 DP1 BLK	1089 001 BLK	0.7/2.6
White	931/932	2-3/4 x 3-1/4	1089 DP1 WHT	1089 001 WHT	0.7/2.6
Black	1031/1032	3-1/4 x 3-3/4	1089 DP3 BLK	1089 003 BLK	0.9/3.4
White	1031/1032	3-1/4 x 3-3/4	1089 DP3 WHT	1089 003 WHT	0.9/3.4



**Fig. 1089**

## FLUSH LOCKS & LATCHES

**FIGS. 1071 & 1072 - FLUSH LOCK & LATCH FOR CARPETED SURFACES**  
**FIGS. 1081 & 1082 - FLUSH LOCK & LATCH FOR SMOOTH OR CARPETED SURFACES**  
 (GASKET INCLUDED FOR SMOOTH SURFACE APPLICATIONS)

**CONSTRUCTION OPTIONS:**

- \* BLACK OR WHITE PLASTIC
- \* STAINLESS STEEL "D" RING HANDLE
- \* STEM AND LOCK NUT
- \* TWO O-RINGS FOR INCREASED WATER RESISTANCE
- \* POSITION INDICATOR SHOWS OPEN OR CLOSED POSITION

**FLEXIBLE  
PLASTIC  
STRIKE**



**FIG. 1071 - LOCK WITH 2 KEYS**  
**FIG. 1072 - LATCH (NON-LOCKING)**

**FIG. 1081 - LOCK WITH 2 KEYS**  
**FIG. 1082 - LATCH (NON-LOCKING)**

- No. 1 with Offset Cam Bar and Flexible Plastic Strike Plate
- No. 2 with Offset Adjustable Cam Bar
- No. 3 with Straight Cam Bar and Flexible Plastic Strike Plate

Easily Installs in a 2-3/8 Inch Diameter Hole  
 For Mounting Surfaces 3/8 to 7/8 Inches Thick



**FIG.**  
**1071 #1 BLK**



**FIG.**  
**1072 #2 BLK**



**FIG.**  
**1081 #3 BLK**



### ORDERING INFORMATION

Finish	Type	Adjustment Cam Bar Inches	Dimensions Face Plate Inches	Figs. 1071/1072 OEM Bulk Pkg. 25 Pcs.	Figs. 1081/1082 Dealer Pkg. - 5 Cards 1 Pc. per Card	Figs. 1081/1082 OEM Bulk Pkg. 25 Pcs.	Ship Wt. Carton Lbs. DP/OEM Bulk
Black	Lock	3/8 to 3	2-7/8 x 2-7/8	1071 001 BLK	1081 DP1 BLK	1081 001 BLK	3.4/12.4
Black	Lock	3/8 to 3	2-7/8 x 2-7/8	1071 002 BLK	1081 DP2 BLK	1081 002 BLK	3.3/11.3
Black	Lock	1-1/16 to 2-9/16	2-7/8 x 2-7/8	1071 003 BLK	1081 DP3 BLK	1081 003 BLK	3.5/12.7
Black	Latch	3/8 to 3	2-7/8 x 2-7/8	1072 001 BLK	1082 DP1 BLK	1082 001 BLK	3.1/11.1
Black	Latch	3/8 to 3	2-7/8 x 2-7/8	1072 002 BLK	1082 DP2 BLK	1082 002 BLK	3.0/11.0
Black	Latch	1-1/16 to 2-9/16	2-7/8 x 2-7/8	1072 003 BLK	1082 DP3 BLK	1082 003 BLK	3.2/12.2
White	Lock	3/8 to 3	2-7/8 x 2-7/8	1071 001 WHT	1081 DP1 WHT	1081 001 WHT	3.4/12.4
White	Lock	3/8 to 3	2-7/8 x 2-7/8	1071 002 WHT	1081 DP2 WHT	1081 002 WHT	3.3/11.3
White	Lock	1-1/16 to 2-9/16	2-7/8 x 2-7/8	1071 003 WHT	1081 DP3 WHT	1081 003 WHT	3.5/12.7
White	Latch	3/8 to 3	2-7/8 x 2-7/8	1072 001 WHT	1082 DP1 WHT	1082 001 WHT	3.0/11.1
White	Latch	3/8 to 3	2-7/8 x 2-7/8	1072 002 WHT	1082 DP2 WHT	1082 002 WHT	2.9/11.0
White	Latch	1-1/16 to 2-9/16	2-7/8 x 2-7/8	1072 003 WHT	1082 DP3 WHT	1082 003 WHT	3.2/12.2

Spare Offset Cam Bar, Cat. No. 931 001 99A.  
 Spare Straight Cam Bar, Cat. No. 931 003 99A.

Spare Offset Adjustable Cam Bar, Cat. No. 931 002 99A.  
 Flexible Plastic Strike Cat. No. 931 000 99B

## LOCK & LATCH SET SELECTION GUIDE

Series	Type	Size	Mounting Surface Thickness	Lock & Latch Set Features	Page
931 	Lock	2-1/2" x 2-1/2"	1/4" to 1-1/8"	Available Black or White; #1 Offset Cam Bar; #2 Offset Adjustable Cam Bar; #3 Straight Cam Bar. Adjustable 3/8" to 3", used on doors etc.	172
932 	Latch				
1071 	Lock	2-7/8" x 2-7/8"	3/8" to 1-1/4"	Available Black or White; #1 Offset Cam Bar; #2 Offset Adjustable Cam Bar; #3 Straight Cam Bar. Used on carpeted surfaces. Adjustable 3/8" to 3". Stainless Steel Handle.	173
1072 	Latch				
1081 	Lock	2-7/8" x 2-7/8"	3/8" to 1-1/4"	Available Black or White; #1 Offset Cam Bar; #2 Offset Adjustable Cam Bar; #3 Straight Cam Bar. Used on smooth or carpeted surfaces. Adjustable 3/8" to 3". Stainless Steel Handle.	173
1082 	Latch				
1031 	Lock	3-1/8" x 3-1/8"	1/8" to 3/4"	Available Black or White. Offset Cam Bar only; Adjustable 1/2" to 3". Extra large handle.	172
1032 	Latch				
1091 	Lock	3" Dia.	1/8" to 3/4"	Available Black or White. #1 Offset Cam Bar; #3 Straight Cam Bar; #4 Extra Long Offset Cam Bar and #5 Extra Long Straight Cam Bar Used on Smooth or Carpeted Surfaces. Adjustable 3/8" to 3". Chrome Plated Zinc Alloy "T" Handle	170 171
1092 	Latch				

### Cam Bars for 931/932, 1071/1072 and 1081/1082 Series Lock & Latch Sets

#1 Style Cam Bar\*\*

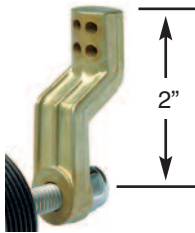

Offset Cam Bar  
For 5/16" Shafts

#2 Style Cam Bar\*\*

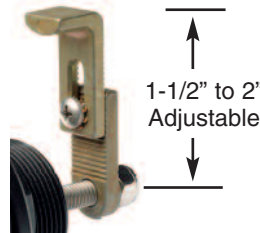

Offset Adjustable  
Cam Bar  
For 5/16" Shafts

#3 Style Cam Bar\*\*

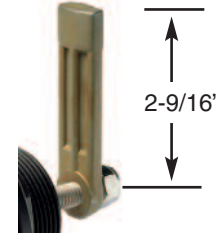

Straight Cam Bar  
For 5/16" Shafts

### Cam Bars for 1091/1092 and 1031/1032 Series Lock & Latch Sets

#1 Style Cam Bar\*\*\*

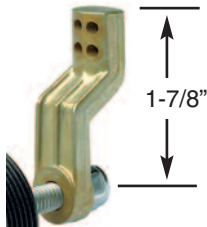

Offset Cam Bar  
For 1091/1092  
For 3/8" Shafts

#3 Style Cam Bar\*\*\*

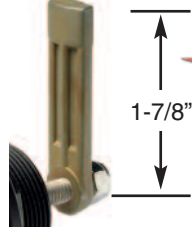

Straight Cam Bar  
For 1091/1092  
For 3/8" Shafts

#4 Style Cam Bar\*\*\*

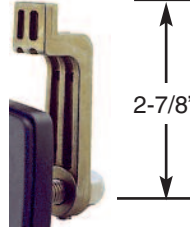

#4 Extra Long Offset  
Cam Bar as used on  
1091/1092 & 1031/1032  
for 3/8" Shafts

#5 Style Cam Bar\*\*\*

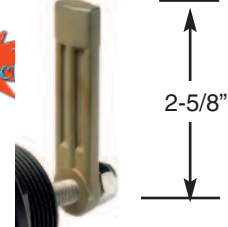

#5 Extra Long  
Straight Cam Bar as  
used on 1091/1092 for  
3/8" Shafts

\*\* Measurements are from the center of the lockset to the top of the cam bar shaft end.  
\*\*\*Note: 1091/1092 series have offset center shafts, add 5/8" for Dimension from center.

## FLUSH HATCH DOG, LOCK & LATCH

**FIG. 777 - FLUSH HATCH DOG**

**CONSTRUCTION:**

- \* CHROME PLATED BRASS
- \* STAINLESS STEEL LOCK NUTS
- \* WITH FLUSH STRIKE
- \* O-RING SEALS FOR WATER RESISTANCE
- \* DOES NOT RATTLE WHEN "DOGGED" DOWN

For Securely "Dogging" (Fastening) Deck Hatches



**FIG. 777  
SHOWN WITH  
#0 CAM BAR**

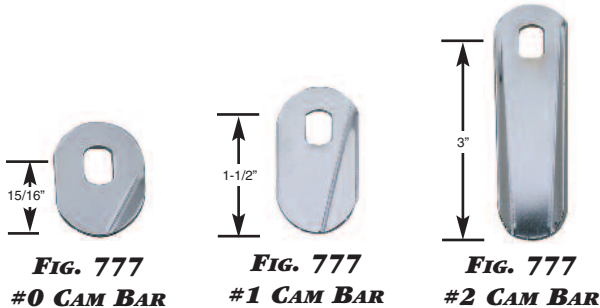

**FIG. 777  
#0 CAM BAR**

**FIG. 777  
#1 CAM BAR**

**FIG. 777  
#2 CAM BAR**



**ORDERING INFORMATION**

For Max. Hatch Thickness Inches	Adjustment Cam Bar Inches	Dimensions Face Plate Inches	Standard Pkg. - 1 Pc. OEM Pkg. - 5 Pcs.	Screw Size	Ship Wt. Carton Lbs. Std. Pkg.
2	1-1/4 to 2	3-13/16 x 3	777 000 CHR	8	1.2
2	1-1/4 to 2	3-13/16 x 3	777 001 CHR	8	1.2
2	1-1/4 to 2	3-13/16 x 3	777 002 CHR	8	1.3

Spare Cam Bar for Size #0, Cat No. 777 000 99A. Spare Cam Bar for Size #1, Cat No. 777 001 99A. Spare Cam Bar for Size #2, Cat No. 777 002 99A.

**FIGS. 921 & 922 - FLUSH LOCK & LATCH**

**CONSTRUCTION:**

- \* CHROME PLATED ZINC ALLOY

**FIG. 921 - LOCK WITH 2 KEYS**

**FIG. 922 - NON-LOCKING LATCH**

Easily Installs in a 1-5/8 Inch Diameter Hole  
For Door Thickness 1/2 to 3/4 Inches

**FIG. 921  
SHOWN**



Cabinet Hardware

**ORDERING INFORMATION**

Type	Dimensions Face Plate Inches	Dealer Pkg. - 5 Cards 1 Pc. per Card	OEM Bulk Pkg. 25 Pcs.	Ship Wt. Carton Lbs. DP/OEM Bulk
Lock	2-1/4 x 2	921 DP CHR	921 000 CHR	2.8/12.4
Latch	2-1/4 x 2	922 DP CHR	922 000 CHR	2.5/11.1

Spare Chrome Cam Bar, Cat. No. 980A.

Note: Chrome and Plastic Cam Bars are not interchangeable.

## LOCKS & LATCHES

### **FIGS. 710, 711, 712 LATCH SETS**

### **FIGS. 730 & 731 LOCK SETS**

### **PRIVACY LOCKS & LATCHES FOR INTERIOR CABINS AND HEAD ENCLOSURES**

Locks by Turn Button from Inside

#### **CONSTRUCTION:**

- \* CHROME PLATED ZINC ALLOY
- \* DECORATIVE GOLD TONE PVD (FIG. 710 GOLD) (PHYSICAL VAPOR DEPOSITION)
- \* TWO TONE ESCUTCHEON PLATES (FIG. 710 CHROME)
  - \* BRASS & PLASTIC
- \* NEW CONTEMPORARY STYLING
- \* OVERALL HEIGHT - 5-1/4 INCHES
- \* SAFETY UNLOCK FROM OUTSIDE
- \* INTERIOR LOCK MECHANISM



**FIG. 710**  
**CHROME**  
**MORTISE LATCH**



**FIG. 710**  
**GOLD TONE PVD**  
**MORTISE LATCH**

#### **FIG. 710 - MORTISE LATCH SET**

#### **CHROME PLATED OR GOLD**

For Door Thickness 3/4 to 1-1/2 Inches

Left Inward/Right Outward are Interchangeable  
Right Inward/Left Outward are Interchangeable

#### **FIG. 711 - FLUSH LATCH SET**

For Door Thickness 1/2 to 3/4 Inches

#### **FIG. 712 - MORTISE LATCH SET**

For Door Thickness 3/4 to 1-1/2 Inches

Left Inward/Right Outward are Interchangeable  
Right Inward/Left Outward are Interchangeable

#### **FIG. 730 - MORTISE LOCK SET**

For Door Thickness 3/4 to 1-1/2 Inches

Left Inward/Right Outward are Interchangeable  
Right Inward/Left Outward are Interchangeable

#### **FIG. 731 - FLUSH LOCK SET**

For Door Thickness 1/2 to 3/4 Inches



**FIG. 712**  
**MORTISE LATCH**

**FIG. 711**  
**FLUSH LATCH**



**FIG. 730**  
**MORTISE LOCK**



**FIG. 731**  
**FLUSH LOCK**



## LOCKS & LATCHES

### ORDERING INFORMATION

Type	For Door Thickness Inches	Chrome/Brass Standard Pkg. 1 Set	Gold Tone PVD Standard Pkg. 1 Set	Type Of Lock/Latch	Ship Wt. Carton Lbs. Standard Pkg.
Mortise Latch	3/4 to 1	710-001-LIC	710-G01-LIC	Left In or Right Out	1.5
Mortise Latch	3/4 to 1	710-001-RIC	710-G01-RIC	Right In or Left Out	1.5
Mortise Latch	1 to 1-1/4	710-002-LIC	710-G02-LIC	Left In or Right Out	1.5
Mortise Latch	1 to 1-1/4	710-002-RIC	710-G02-RIC	Right In or Left Out	1.5
Mortise Latch	1-1/4 to 1-1/2	710-003-LIC	710-G03-LIC	Left In or Right Out	1.5
Mortise Latch	1-1/4 to 1-1/2	710-003-RIC	710-G03-RIC	Right In or Left Out	1.5
Mortise Lock	3/4 to 1	730-001-LIC	-----	Left In or Right Out	1.7
Mortise Lock	3/4 to 1	730-001-RIC	-----	Right In or Left Out	1.7
Mortise Lock	1 to 1-1/4	730-002-LIC	-----	Left In or Right Out	1.7
Mortise Lock	1 to 1-1/4	730-002-RIC	-----	Right In or Left Out	1.7
Mortise Lock	1-1/4 to 1-1/2	730-003-LIC	-----	Left In or Right Out	1.7
Mortise Lock	1-1/4 to 1-1/2	730-003-RIC	-----	Right In or Left Out	1.7
Flush Latch	1/2	711-001-LIC	-----	Left Inward	1.5
Flush Latch	1/2	711-001-LOC	-----	Left Outward	1.5
Flush Latch	1/2	711-001-RIC	-----	Right Inward	1.5
Flush Latch	1/2	711-001-ROC	-----	Right Outward	1.5
Flush Latch	5/8	711-002-LIC	-----	Left Inward	1.5
Flush Latch	5/8	711-002-LOC	-----	Left Outward	1.5
Flush Latch	5/8	711-002-RIC	-----	Right Inward	1.5
Flush Latch	5/8	711-002-ROC	-----	Right Outward	1.5
Flush Latch	3/4	711-003-LIC	-----	Left Inward	1.5
Flush Latch	3/4	711-003-LOC	-----	Left Outward	1.5
Flush Latch	3/4	711-003-RIC	-----	Right Inward	1.5
Flush Latch	3/4	711-003-ROC	-----	Right Outward	1.5
Flush Lock	1/2	731-001-LIC	-----	Left Inward	1.6
Flush Lock	1/2	731-001-LOC	-----	Left Outward	1.6
Flush Lock	1/2	731-001-RIC	-----	Right Inward	1.6
Flush Lock	1/2	731-001-ROC	-----	Right Outward	1.6
Flush Lock	5/8	731-002-LIC	-----	Left Inward	1.6
Flush Lock	5/8	731-002-LOC	-----	Left Outward	1.6
Flush Lock	5/8	731-002-RIC	-----	Right Inward	1.6
Flush Lock	5/8	731-002-ROC	-----	Right Outward	1.6
Flush Lock	3/4	731-003-LIC	-----	Left Inward	1.6
Flush Lock	3/4	731-003-LOC	-----	Left Outward	1.6
Flush Lock	3/4	731-003-RIC	-----	Right Inward	1.6
Flush Lock	3/4	731-003-ROC	-----	Right Outward	1.6
Mortise Latch	3/4 to 1	712-001-LIC	-----	Left In or Right Out	1.5
Mortise Latch	3/4 to 1	712-001-RIC	-----	Right In or Left Out	1.5
Mortise Latch	1 to 1-1/4	712-002-LIC	-----	Left In or Right Out	1.5
Mortise Latch	1 to 1-1/4	712-002-RIC	-----	Right In or Left Out	1.5
Mortise Latch	1-1/4 to 1-1/2	712-003-LIC	-----	Left In or Right Out	1.5
Mortise Latch	1-1/4 to 1-1/2	712-003-RIC	-----	Right In or Left Out	1.5

### DETERMINING THE HAND OF THE LATCH SET.

#### WHEN STANDING OUTSIDE

**IF THE DOOR OPENS AWAY FROM YOU, THEN YOU NEED A LOCK OR LATCH WITH A REGULAR BEVEL.**

**IF THE DOOR OPENS TOWARD YOU, THEN YOU NEED A LOCK OR LATCH WITH A REVERSE BEVEL.**

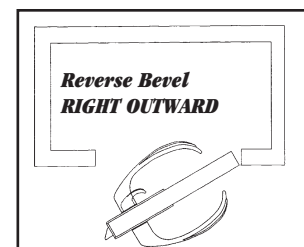
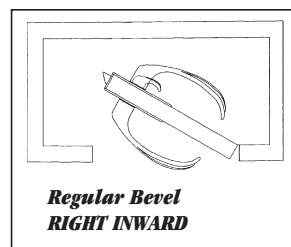
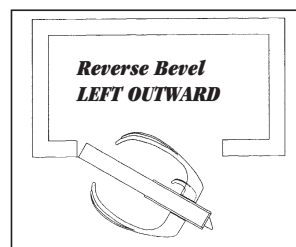
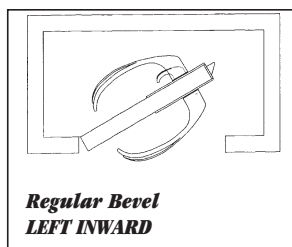

**NOTE:** The privacy latch handle should always be mounted on the door's interior side

## LATCH SETS

### FIGS. 1239 & 1240 - FLUSH CUP RIM LATCH SETS

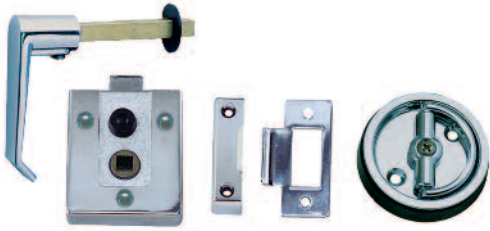

**FIGS. 1239 & 1240**

**CONSTRUCTION:**

- \* CHROME PLATED ZINC ALLOY
- \* SLIDING LOCK BUTTON

**FIG. 1239 - REGULAR BEVEL WITH BOX STRIKE**  
**FIG. 1240 - REVERSE BEVEL WITH FLUSH STRIKE**

Supplied with Black Plastic Spacer For Surface Mounting  
 For Door Thickness 5/8 to 1 Inch.



**ORDERING INFORMATION**

Bevel Type	Dimensions Case Inches	O.D. Cup Inches	Dealer Pkg. 5 Sets 1 Set per Pkg.	OEM Bulk Pkg. 10 Sets	Ship Wt. Carton Lbs. DP/OEM Bulk
Regular	2 x 2-1/4	2-1/4	1239 DP CHR	1239 000 CHR	4.6/8.7
Reverse	2 x 2-1/4	2-1/4	1240 DP CHR	1240 000 CHR	4.4/8.2

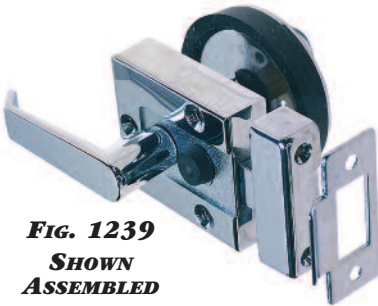

**FIG. 1239**  
**SHOWN ASSEMBLED**

Case and Cup Both, Screw Size #8. Spare Box Strike, Cat. No. 977 000 CHR.  
 Spare Regular Bevel w/Cam, Cat. No. 984 000 CHR. Spare Flush Strike, Cat. No. 912 DP CHR.  
 Spare Reverse Bevel w/Cam, Cat. No. 920 DP CHR.

### FIGS. 991 & 992 - FLUSH LATCH SETS

**CONSTRUCTION:**

- \* CHROME PLATED ZINC ALLOY
- \* SLIDING LOCK BUTTON

For Door Thickness 1/2 to 3/4 Inches

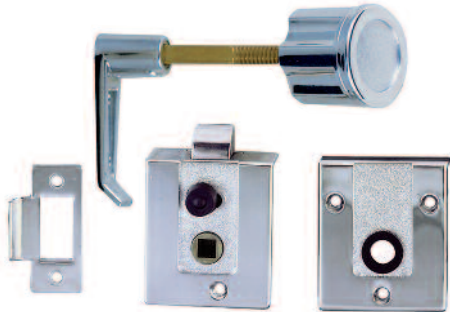

**FIGS. 991 & 992**

**FIG. 991 - REGULAR BEVEL WITH FLUSH STRIKE**  
**FIG. 992 - REVERSE BEVEL WITH FLUSH STRIKE**

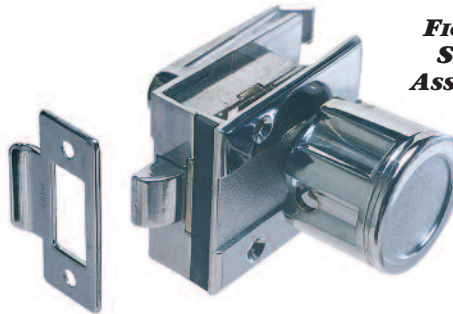

**FIG. 991**  
**SHOWN ASSEMBLED**

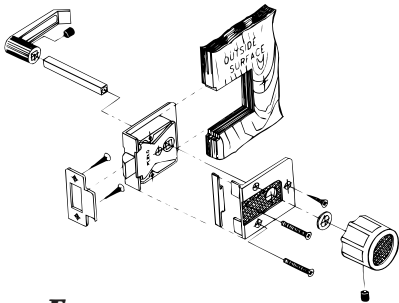

**EXPLODED VIEW SHOWS FIG. 992**

**ORDERING INFORMATION**

Bevel Type	Dimensions Case Inches	Dimensions Escutcheon Inches	Dealer Pkg. 5 Sets 1 Set per Pkg.	OEM Bulk Pkg. 10 Sets	Screw Size	Ship Wt. Carton Lbs. DP/OEM Bulk
Regular	1-5/8 x 1-5/8	2 x 2-1/4	991 DP CHR	991 000 CHR	6	5.1/9.5
Reverse	1-5/8 x 1-5/8	2 x 2-1/4	992 DP CHR	992 000 CHR	6	5.1/9.5

Spare Flush Strike, Cat. No. 912 DP CHR. Spare Regular Bevel with Cam, Cat. No. 984 000 CHR.  
 Spare Knob and Handle, Cat. No. 995 000 CHR. Spare Reverse Bevel with Cam, Cat. No. 920 DP CHR.



## LATCH SETS

### FIGS. 929 & 1029 - RIM LATCH SETS

**CONSTRUCTION:**

- \* CHROME PLATED ZINC ALLOY
- \* SLIDING LOCK BUTTON

For Door Thickness 1/2 to 1 Inch.

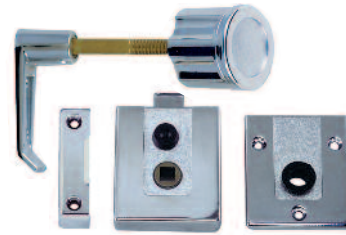

**FIGS. 929 & 1029**

**FIG. 929 - REGULAR BEVEL WITH BOX STRIKE**

**FIG. 1029 - REVERSE BEVEL WITH BOX STRIKE**



**FIG. 929  
SHOWN  
ASSEMBLED**



### ORDERING INFORMATION

Bevel Types	Dimensions Case Inches	Dimensions Escutcheon Inches	Dealer Pkg. 5 Sets 1 Set per Card	OEM Bulk Pkg. 10 Sets	Screw Size	Ship Wt. Carton Lbs. DP/OEM Bulk
Regular	2 x 2-1/4	2 x 2-1/4	929 DP CHR	929 000 CHR	6	5.7/10.7
Reverse	2 x 2-1/4	2 x 2-1/4	1029 DP CHR	1029 000 CHR	6	5.7/10.7

Spare Box Strike, Cat. No. 977 000 CHR.

Spare Regular Bevel with Cam, Cat. No. 984 000 CHR.

Spare Knob and Handle Assembly, Cat. No. 995 000 CHR.

Spare Reverse Bevel with Cam, Cat. No. 920 DP CHR.

### FIGS. 968 & 1068 - RIM LATCH SETS

**CONSTRUCTION:**

- \* CHROME PLATED ZINC ALLOY
- \* SLIDING LOCK BUTTON

For Door Thickness 1/2 to 1 Inch.



**FIGS. 968 & 1068**

**FIG. 968 - REGULAR BEVEL WITH FLUSH STRIKE**

**FIG. 1068 - REVERSE BEVEL WITH FLUSH STRIKE**

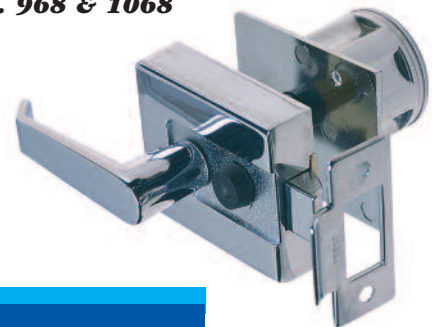

**FIG. 968  
SHOWN  
ASSEMBLED**



### ORDERING INFORMATION

Bevel Types	Dimensions Case Inches	Dimensions Escutcheon Inches	Dealer Pkg. 5 Sets 1 Set per Card	OEM Bulk Pkg. 10 Sets	Screw Size	Ship Wt. Carton Lbs. DP/OEM Bulk
Regular	2 x 2-1/4	2 x 2-1/4	968 DP CHR	968 000 CHR	6	5.5/10.3
Reverse	2 x 2-1/4	2 x 2-1/4	1068 DP CHR	1068 000 CHR	6	5.5/10.3

Spare Flush Strike, Cat. No. 912 DP CHR.

Spare Regular Bevel with Cam, Cat. No. 984 000 CHR.

Spare Knob and Handle Assembly, Cat. No. 995 000 CHR.

Spare Reverse Bevel with Cam, Cat. No. 920 DP CHR.

## LATCH & LOCK SETS

### Figs. 918 & 919 - RIM LOCK SETS

#### CONSTRUCTION:

\* **CHROME PLATED ZINC ALLOY**

For Door Thickness 5/8 to 1-3/8 Inches

**FIG. 918 - REGULAR BEVEL WITH BOX STRIKE**

**FIG. 919 - REVERSE BEVEL WITH FLUSH STRIKE**

Locks by Turn Button from Inside or Key from Outside

**FIG. 918  
SHOWN  
ASSEMBLED**

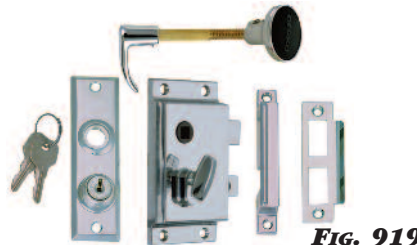

**FIG. 918**

**FIG. 919**



#### ORDERING INFORMATION

Door Bevel/Strike Type	Dimensions Case Inches	Dimensions Escutcheon Inches	Dealer Pkg. 5 Sets 1 Set per Card	OEM Bulk Pkg. 10 Sets	Screw Size	Ship Wt. Carton Lbs. DP/OEM Bulk
Regular w/Box	3-7/8 x 2	4-3/8 x 1-1/4	918 DP CHR	918 000 CHR	6	7.1/12.2
Reverse w/Flush	3-7/8 x 2	4-3/8 x 1-1/4	919 DP CHR	919 000 CHR	6	6.8/12.3

Spare Box Strike, Cat. No. 918 000 99A.

Spare Flush Strike, Cat. No. 913 DP CHR.

Spare Knob and Handle Assembly, Cat. No. 962 000 CHR.

Spare Regular Bevel with Cam, Cat. No. 984 000 CHR.

Spare Reverse Bevel with Cam, Cat. No. 920 DP CHR.

Spare Escutcheon Plate with Keys, Cat. No. 953 000 CHR.

### Figs. 1279 & 1280 - FLUSH CUP RIM LATCH SETS

#### CONSTRUCTION:

\* **CHROME PLATED ZINC ALLOY**

\* **SLIDING LOCK BUTTON**

For Door Thickness 3/4 to 1-1/8 Inches

**FIG. 1279 - REGULAR BEVEL WITH BOX STRIKE**

**FIG. 1280 - REVERSE BEVEL WITH FLUSH STRIKE**

Supplied with Black Plastic Spacer for Surface Mounting

**FIG. 1279  
SHOWN  
ASSEMBLED**



**FIG. 1279**

**FIG. 1280**



#### ORDERING INFORMATION

Bevel/Strike Type	Dimensions Case Inches	O.D. Cup Inches	Dealer Pkg. 5 Sets 1 Set per Card	OEM Bulk Pkg. 10 Sets	Ship Wt. Carton Lbs. DP/OEM Bulk
Regular w/Box	2-1/8 x 1-3/4	2 x 2-1/4	1279 DP CHR	1279 000 CHR	4.1/7.2
Reverse w/Flush	2-1/8 x 1-3/4	2 x 2-1/4	1280 DP CHR	1280 000 CHR	4.0/6.9

Case Screw Size #6

Spare Box Strike, Cat. No. 976 000 CHR.

Spare Flush Strike, Cat. No. 912 DP CHR.

Cup Screw Size #8

Spare Regular Bevel with Cam, Cat. No. 984 000 CHR.

Spare Reverse Bevel with Cam, Cat. No. 920 DP CHR.

## LATCH SETS

### FIGS. 928 & 1028 - RIM LATCH SETS

**CONSTRUCTION:**

- \* CHROME PLATED ZINC ALLOY
- \* SLIDING LOCK BUTTON

For Door Thickness 5/8 to 1-3/8 Inches

**FIG. 928 - REGULAR BEVEL WITH BOX STRIKE**

**FIG. 1028 - REVERSE BEVEL WITH BOX STRIKE**



**FIGS. 928 & 1028**

**FIG. 928  
SHOWN  
ASSEMBLED**



### ORDERING INFORMATION

Bevel Type	Dimensions Case Inches	Dimensions Escutcheon Inches	Dealer Pkg. 5 Sets 1 Set per Card	OEM Bulk Pkg. 10 Sets	Screw Size	Ship Wt. Carton Lbs. DP/OEM Bulk
Regular	2-1/8 x 1-3/4	4-3/8 x 1-1/4	928 DP CHR	928 000 CHR	6	4.5/8.1
Reverse	2-1/8 x 1-3/4	4-3/8 x 1-1/4	1028 DP CHR	1028 000 CHR	6	4.5/8.1

Spare Box Strike, Cat. No. 976 000 CHR.

Spare Regular Bevel with Cam, Cat. No. 984 000 CHR.

Spare Knob and Handle Assembly, Cat. No. 962 000 CHR.

Spare Reverse Bevel with Cam, Cat. No. 920 DP CHR.

### FIGS. 930 & 1030 - RIM LATCH SETS

**CONSTRUCTION:**

- \* CHROME PLATED ZINC ALLOY
- \* SLIDING LOCK BUTTON

For Door Thickness 5/8 to 1-3/8 Inches

**FIG. 930 - REVERSE BEVEL WITH FLUSH STRIKE**

**FIG. 1030 - REGULAR BEVEL WITH FLUSH STRIKE**



**FIGS. 930 & 1030**

**FIG. 930  
SHOWN  
ASSEMBLED**



### ORDERING INFORMATION

Bevel Type	Dimensions Case Inches	Dimensions Escutcheon Inches	Dealer Pkg. 5 Sets 1 Set per Card	OEM Bulk Pkg. 10 Sets	Screw Size	Ship Wt. Carton Lbs. DP/OEM Bulk
Reverse	2-1/8 x 1-3/4	4-3/8 x 1-1/4	930 DP CHR	930 000 CHR	6	4.3/7.7
Regular	2-1/8 x 1-3/4	4-3/8 x 1-1/4	1030 DP CHR	1030 000 CHR	6	4.3/7.7

Spare Flush Strike, Cat. No. 912 DP CHR.

Spare Regular Bevel with Cam, Cat. No. 984 000 CHR.

Spare Knob and Handle Assembly, Cat. No. 962 000 CHR.

Spare Reverse Bevel with Cam, Cat. No. 920 DP CHR.

## LATCH & LOCK SETS

**FIG. 927**  
**SHOWN**  
**ASSEMBLED**



**FIG. 927**

**FIG. 927 - MORTISE LOCK SET**

**CONSTRUCTION:**

\* **CHROME PLATED ZINC ALLOY**

Locks by Turn Button from Inside or  
Key from Outside  
Bevel can be Reversed During Installation



**ORDERING INFORMATION**

For Door Thickness Inches	Dimensions Case Inches	Dimensions Escutcheon Inches	Dealer Pkg. 5 Sets 1 Set per Card	OEM Bulk Pkg. 10 Sets	Screw Size	Ship Wt. Carton Lbs. DP/OEM Bulk
1 to 1-3/8	2-3/4 x 2	4-3/8 x 1-1/4	927 DP CHR	927 000 CHR	6	7.0/12.8

Spare Flush Strike, Cat. No. 913 DP CHR.

Spare Bevel with Cam, Cat. No. 920 DP CHR.

Spare Knob and Handle Assy, Cat. No. 962 000 CHR.

Spare Escutcheon Plate with Keys, Cat. No. 927 000 99B.

**FIG. 960**  
**SHOWN**  
**ASSEMBLED**



**FIG. 960**

**FIG. 960 - MORTISE LATCH SET**

**CONSTRUCTION:**

\* **CHROME PLATED ZINC ALLOY**

\* **TURN BUTTON LOCK**

Bevel can be Reversed During Installation



**ORDERING INFORMATION**

For Door Thickness Inches	Dimensions Case Inches	Dimensions Escutcheon Inches	Dealer Pkg. 5 Sets 1 Set per Card	OEM Bulk Pkg. 10 Sets	Screw Size	Ship Wt. Carton Lbs. DP/OEM Bulk
1 to 1-3/8	2-1/4 x 1-13/16	4-3/8 x 1-1/4	960 DP CHR	960 000 CHR	6	5.8/10.3

Spare Flush Strike, Cat. No. 912 DP CHR.

Spare Bevel with Cam, Cat. No. 960 000 99A.

Spare Knob and Handle Assembly, Cat. No. 962 000 CHR.

**FIG. 567 - TUBULAR LATCH SET**

**CONSTRUCTION:**

\* **CHROME PLATED ZINC ALLOY.**

\* **SLIDING LOCK BUTTON.**



**ORDERING INFORMATION**

For Door Thickness Inches	Dimensions Escutcheon Inches	O.D. Tube Inches	Dealer Pkg. 5 Cards 1 Set per Card	OEM Bulk Pkg. 10 Sets	Screw Size	Ship Wt. Carton Lbs. DP/OEM Bulk
1 to 1-3/8	4-3/8 x 1-1/4	3/4	567 DP CHR	567 000 CHR	6	4.4/8.2

Spare Flush Strike, Cat. No. 912 DP CHR.

Spare Knob and Handle Assembly, Cat. No. 962 000 CHR.

## CUPBOARD BOLT, CATCH, TURN & LATCH

**FIG. 1101 - CUPBOARD BOLT**

**CONSTRUCTION:**

- \* CHROME PLATED ZINC ALLOY
- \* BLACK PLASTIC SLIDE AND KNOB



**ORDERING INFORMATION**

Dimensions Overall Inches	Dealer Pkg. 5 Cards 1 Pc. per Card	OEM Bulk Pkg. 50 Pcs.	Screw Size	Ship Wt. Carton Lbs. DP/OEM Bulk
2-1/8 x 1-1/2	1101 DP CHR	1101 000 CHR	6	0.9/6.4



**FIG. 1101**

**FIG. 1102 - CUPBOARD CATCH**

**CONSTRUCTION:**

- \* CHROME PLATED ZINC ALLOY

**No. 1 SUPPLIED WITH BOX STRIKE**

**No. 2 SUPPLIED WITH 3/8 INCH OFFSET BOX STRIKE**



**ORDERING INFORMATION**

Strike Type	Dimensions Overall Inches	Dealer Pkg. 5 Cards 1 Pc. per Card	OEM Bulk Pkg. 50 Pcs.	Screw Size	Ship Wt. Carton Lbs. DP/OEM Bulk
Box	1-1/2 x 1-7/8	1102 DP1 CHR	1102 001 CHR	6	1.2/9.9
Offset Box	1-1/2 x 1-7/8	1102 DP2 CHR	1102 002 CHR	6	1.3/10.4

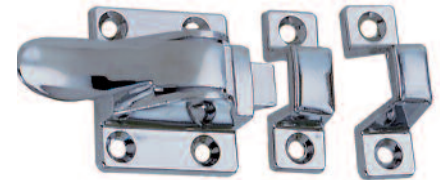

**FIG. 1102**

**FIG. 978 - CUPBOARD TURN**

**CONSTRUCTION:**

- \* CHROME PLATED ZINC ALLOY



**ORDERING INFORMATION**

Dimensions Overall Inches	Dealer Pkg. 5 Cards 1 Pc. per Card	Screw Size	Ship Wt. Carton Lbs. Dealer Pkg.
2-1/8 x 2-1/4	978 DP CHR	6	2.0

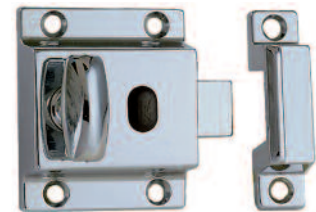

**FIG. 978**

Spare Strike Plate, Cat. No. 976 000 CHR. Spare Bevel with Cam, Cat. No. 984 000 CHR.

**FIG. 948 - LATCH**

**CONSTRUCTION:**

- \* CHROME PLATED ZINC ALLOY
- \* SLIDING LOCK BUTTON



**ORDERING INFORMATION**

Dimensions Overall Inches	Dealer Pkg. 5 Cards 1 Pc. per Card	Screw Size	Ship Wt. Carton Lbs. Dealer Pkg.
2-1/8 x 2-1/4	948 DP CHR	6	2.0

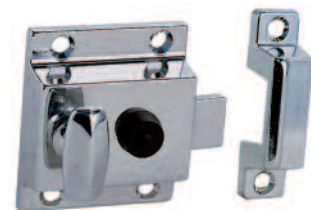

**FIG. 948**

Spare Strike Plate, Cat. No. 976 000 CHR.  
Spare Bevel with Cam, Cat. No. 984 000 CHR.

**FIG. 938 - PULL AND LATCH ASSEMBLY**



**Fig. 938**

**CONSTRUCTION:**

- \* **CHROME PLATED ZINC ALLOY**
- \* **BLACK PLASTIC INSERT**
- \* **BRASS STEM**



**ORDERING INFORMATION**

O.D. Knob Inches	Max. Panel Thickness Inches	Dealer Pkg. - 5 Cards 1 Pc. per Card	OEM Bulk Pkg. 50 Pcs.	Ship Wt. Carton Lbs. DP/OEM Bulk
1-1/2	1-1/8	938 DP CHR	938 000 CHR	1.0/5.3

Spare Cam Bar, Cat. No. 938 000 99A.

**FIG. 1056 - ELBOW CATCH**



**Fig. 1056**

**CONSTRUCTION:**

- \* **CHROME PLATED ZINC ALLOY**
- \* **STAINLESS STEEL SPRING**



**ORDERING INFORMATION**

Dimensions Inches	Dealer Pkg. - 10 Cards 1 Pcs. per Card	OEM Bulk Pkg. 50 Pcs.	Screw Size	Ship Wt. Carton Lbs. DP/OEM Bulk
1-1/8 x 9/16	1056 DP CHR	1056 000 CHR	6	1.0/3.3

**FIG. 1021 - ELBOW CATCH**



**Fig. 1021**

**CONSTRUCTION:**

- \* **BLACK PLASTIC**
- \* **INTEGRAL SPRING**



**ORDERING INFORMATION**

Dimensions Inches	Dealer Pkg. - 25 Cards 2 Pcs. per Card	OEM Bulk Pkg. 100 Pcs.	Screw Size	Ship Wt. Carton Lbs. DP/OEM Bulk
1-3/16 x 5/8	1021 DP BLK	1021 000 BLK	6	1.6/1.9





## KNOB, "T" HANDLE FLUSH PULL & FLUSH RING CATCH

### FIGS. 925 & 926 - KNOBS

#### CONSTRUCTION:

- \* STAINLESS STEEL SCREW

#### FIG. 925

- \* CHROME PLATED BRASS

#### FIG. 926

- \* CHROME PLATED ZINC ALLOY
- \* BLACK PLASTIC INSERT



Fig. 925



Fig. 926



### ORDERING INFORMATION

O.D. Knob Inches	Max. Panel Thickness Inches	Dealer Pkg. - 10 Cards 1 Pc. per Card	OEM Bulk Pkg. 50 Pcs.	Ship Wt. Carton Lbs. DP/OEM Bulk
1	1-1/8	925 DP CHR	925 000 CHR	1.3/4.8
1-1/8	1-1/8	926 DP0 CHR	926 000 CHR	0.7/4.0
1-1/2	1-1/8	926 DP1 CHR	926 001 CHR	1.0/5.3

### FIG. 1093 - "T" HANDLE FLUSH PULL FOR SMOOTH AND CARPETED SURFACES

(GASKET INCLUDED FOR SMOOTH SURFACE APPLICATIONS)  
(TOOTHED BACK FOR CARPET SURFACE APPLICATIONS)

#### CONSTRUCTION OPTIONS:

- \* BLACK OR WHITE PLASTIC BODY
- \* CHROME PLATED ZINC ALLOY, BLACK OR WHITE PLASTIC "T" HANDLE
- \* STAINLESS STEEL STEM

Easily Installs in a 2-1/2 Inch Diameter Hole  
For Mounting Surfaces 1/8 to 3/4 Inches Thick



### ORDERING INFORMATION

Color Body	Color Handle	Diameter Inches	OEM Bulk Pkg. 25 Pcs.	Ship Wt. Carton Lbs. OEM Bulk
Black	Black Plastic	3	1093 000 BLK	12.0
Black	Chrome Plated	3	1093 000 CHR	14.5
White	White Plastic	3	1093 000 WHT	12.0



Fig. 1093

SEE PAGE 170 & 171 FOR  
MATCHING LOCK & LATCH SETS

### FIG. 1051 - FLUSH RING CATCH

#### CONSTRUCTION:

- \* CHROME PLATED ZINC ALLOY
- \* PHOSPHOR BRONZE SPRING

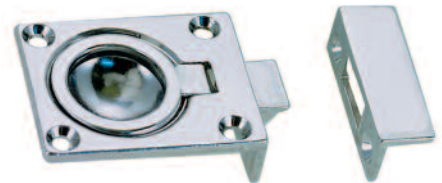

Fig. 1051



### ORDERING INFORMATION

Dimensions Inches	Dealer Pkg. - 10 Cards 1 Pc. per Card	OEM Bulk Pkg. 25 Pcs.	Screw Size	Ship Wt. Carton Lbs. DP/OEM Bulk
2-1/4 x 1-3/8	1051 DP CHR	1051 000 CHR	6	1.7/3.4

## FLUSH PULLS



**Fig. 841**

**FIG. 841 - FLUSH RING PULL**

**CONSTRUCTION:**

\* **CHROME PLATED ZINC ALLOY**



**ORDERING INFORMATION**

Dimensions Face Plate Inches	Dealer Pkg. - 10 Cards 1 Pc. per Card	OEM Bulk Pkg. 50 Pcs.	Screw Size	Ship Wt. Carton Lbs. DP/OEM Bulk
1-3/4 x 1-3/8	841 DP CHR	841 000 CHR	6	1.1/4.3

**FIG. 1232 - FLUSH RING PULL**



**Fig. 1232**

**CONSTRUCTION:**

\* **CHROME PLATED ZINC ALLOY**



**ORDERING INFORMATION**

O.D. Face Plate Inches	Dealer Pkg. - 5 Cards 1 Pc. per Card	OEM Bulk Pkg. 50 Pcs.	Screw Size	Ship Wt. Carton Lbs. DP/OEM Bulk
1-5/8	1232 DP1 CHR	1232 001 CHR	6	0.4/3.4
2	1232 DP2 CHR	1232 002 CHR	6	0.7/4.5

**FIG. 1103 - FLUSH RING PULL**



**Fig. 1103**

**CONSTRUCTION:**

\* **CHROME PLATED BRONZE**



**ORDERING INFORMATION**

Dimensions Face Plate Inches	Dealer Pkg. - 5 Cards 1 Pc. per Card	OEM Bulk Pkg. 50 Pcs.	Screw Size	Ship Wt. Carton Lbs. DP/OEM Bulk
2-9/16 x 2	1103 DP CHR	1103 000 CHR	8	1.3/11.3

**FIG. 575 - FLUSH LIFTING PULL**



**Fig. 575**

**CONSTRUCTION:**

\* **CHROME PLATED BRONZE**



**ORDERING INFORMATION**

Dimensions Face Plate Inches	Dealer Pkg. - 10 Cards 1 Pc. per Card	OEM Bulk Pkg. 50 Pcs.	Screw Size	Ship Wt. Carton Lbs. DP/OEM Bulk
2-5/8 x 2	575 DP CHR	575 000 CHR	8	2.7/11.6

## PULLS & LIFTING HANDLES

**FIG. 1221 - FLUSH PULL**

**CONSTRUCTION:**

- \* **CHROME PLATED ZINC ALLOY**
- \* **BLACK PLASTIC FINISHING FLANGE**

Spring Loaded, Can be Mounted  
Horizontally or Vertically



**FIG. 1221**



**ORDERING INFORMATION**

Dimensions	Dealer Pkg.	OEM	Screw	Ship Wt.
Flange	5 Cards	Bulk Pkg.	Size	Carton Lbs.
Inches	1 Pc. per Card	50 Pcs.		DP/OEM Bulk
3/4 x 3-1/4	1221 DP CHR	1221 000 CHR	8	0.9/6.7

**FIG. 776 - FLUSH LIFTING HANDLE**

**CONSTRUCTION:**

- \* **CHROME PLATED BRONZE**

Size No. 2 (Not Shown) Has All Mounting Holes at Corners



**FIG. 776**



**ORDERING INFORMATION**

Dimensions	Dimensions	Dealer Pkg.	OEM	Screw	Ship Wt.
Face Plate	Inside Handle	5 Cards	Bulk Pkg.	Size	Carton Lbs.
Inches	Inches	1 Pc. per Card	25 Pcs.		DP/OEM Bulk
3 x 2-1/4	1-7/8 x 1	776 DP1 CHR	776 001 CHR	8	1.9/8.3
3-3/4 x 2-3/4	2-3/16 x 1-3/16	776 DP2 CHR	776 002 CHR	8	2.7/11.8

**FIG. 1220 - FLUSH LIFTING HANDLE**

**CONSTRUCTION:**

- \* **CHROME PLATED ZINC ALLOY**



**FIG. 1220**



**ORDERING INFORMATION**

Dimensions	Dimensions	Dealer Pkg.	OEM	Screw	Ship Wt.
Face Plate	Inside Handle	5 Cards	Bulk Pkg.	Size	Carton Lbs.
Inches	Inches	1 Pc. per Card	50 Pcs.		DP/OEM Bulk
3 x 2-1/4	1-7/8 x 1	1220 DP CHR	1220 000 CHR	8	1.5/11.6

## PULLS & SLIDING WINDOW HANDLE

**FIG. 1110 - FLUSH PULL**



**FIG. 1110**

**CONSTRUCTION:**

\* **CHROME PLATED ZINC ALLOY**



**ORDERING INFORMATION**

Dimensions Face Plate Inches	Depth Inches	Dealer Pkg. 5 Cards 1 Pc. per Card	OEM Bulk Pkg. 50 Pcs.	Screw Size	Ship Wt. Carton Lbs. DP/OEM Bulk
3-11/16 x 1-11/16	7/16	1110 DP CHR	1110 000 CHR	6	1.3/9.8

**FIG. 1016 WHITE**

**FIG. 1016 - FLUSH PULL**

**FIG. 1016 BLACK**



**CONSTRUCTION OPTIONS:**

\* **BLACK OR WHITE PLASTIC**

Easily Installs in a 1-3/4 Inch Diameter Hole



**ORDERING INFORMATION**

Color	Dimensions Face Plate Inches	Depth Inches	Dealer Pkg. 10 Cards 1 Pc. per Card	OEM Bulk Pkg. 100 Pcs.	Screw Size	Ship Wt. Carton Lbs. DP/OEM Bulk
Black	2-1/4 x 2-1/4	15/16	1016 DP BLK	1016 000 BLK	6	1.0/4.7
White	2-1/4 x 2-1/4	15/16	1016 DP WHT	1016 000 WHT	6	0.9/4.8



**FIG. 958 - PULL**



**FIG. 958**

**CONSTRUCTION:**

\* **CHROME PLATED ZINC ALLOY**



**ORDERING INFORMATION**

Width Overall Inches	Width Inside Inches	Dealer Pkg. 10 Cards 1 Pc. per Card	Screw Size	Ship Wt. Carton Lbs. Dealer Pkg.
3-7/16	2-5/16	958 DP CHR	6	1.3

**FIG. 954 - SLIDING WINDOW HANDLE**



**FIG. 954**

**CONSTRUCTION:**

\* **STAINLESS STEEL**



**ORDERING INFORMATION**

For Glass Thickness Inches	Length Overall Inches	Dealer Pkg. - 5 Cards 1 Pc. per Card	Ship Wt. Carton Lbs. Dealer Pkg.
1/4	3	954 DP STS	0.7

## WINDOW STOPS, LOCKS & FASTENER

### FIGS. 935 & 966 - SLIDING WINDOW & DOOR STOPS

**CONSTRUCTION:**

- \* **PLASTIC COVER ON STOPPING PLATE**

**FIG. 935 - FOR SLIDING WINDOWS**  
**CHROME PLATED ZINC ALLOY**

**FIG. 966 - FOR SLIDING DOORS**  
**CHROME PLATED HEAVY GAUGE EXTRUDED BRASS**



**FIG. 966**



#### ORDERING INFORMATION

Dimensions Mounting Plate Inches	Length Stopping Plate Inches	Dealer Pkg. 5 Cards 1 Pc. per Card	OEM		Screw Size	Ship Wt. Carton Lbs. DP/OEM Bulk
			OEM Bulk Pkg.	Qty		
1-7/8 x 3/4	1-1/2	935 DP CHR	935 000 CHR	50	8	0.8/6.6
1-1/2 x 3/4	2	966 DP CHR	966 000 CHR	25	10	1.3/5.8



**FIG. 935**

### FIGS. 934 & 937- SLIDING WINDOW LOCK & ANTI-RATTLER

**CONSTRUCTION:**

- \* **CHROME PLATED ZINC ALLOY**
- \* **BLACK PLASTIC KNOB AND TIP**



#### ORDERING INFORMATION

Height Overall Inches	Dimensions Mounting Plate		Dealer Pkg. 5 Cards 1 Pc. per Card	Screw Size	Ship Wt. Carton Lbs. Dealer Pkg.
	Plate Inches	Adjustment Inches			
1	2 x 5/8	1-1/8	934 DP CHR	6	0.6
1-5/8	1 x 5/8	1-1/8	937 DP CHR	6	0.6

Spare Black Plastic Tip, Cat. No. 944.



**FIG. 937**

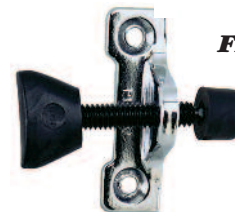

**FIG. 934**

### FIG. 719 - FASTENER

**CONSTRUCTION:**

- \* **CHROME PLATED BRASS**
- \* **BLACK PLASTIC KNOB WITH STAINLESS STEEL STUD**



#### ORDERING INFORMATION

Length Angle Inches	Width Angle Inches	Dealer Pkg. 5 Cards 1 Pc. per Card	OEM		Screw Size	Ship Wt. Carton Lbs. DP/OEM Bulk
			OEM Bulk Pkg.	Qty		
1-3/8	1	719 DP CHR	719 000 CHR	25 Pcs.	8	1.2/4.4

Spare Knob, Cat. No. 719 000 99A

Spare Single Bracket, Cat. No. 719 000 99B

Spare Flat Plate, Cat. No. 719 000 99C



**FIG. 719**

## TABLE BRACKETS & UTILITY HOOKS



**FIG. 148**

**FIG. 148 - TABLE BRACKETS**

**CONSTRUCTION:**

- \* **CHROME PLATED BRASS**  
For Removable Tables

Supplied in Sets Consisting of Two Brackets and Two Wall Plates



**ORDERING INFORMATION**

Dimensions Angle Bracket Inches	Dimensions Wall Plate Inches	Dealer Pkg. 5 Cards 1 Set per Card	OEM Bulk Pkg. 25 Sets	Screw Size	Ship Wt. Carton Lbs. DP/OEM Bulk
2-3/4 x 1-11/16	3-3/8 x 2	148 DP CHR	148 000 CHR	10	4.3/19.7

Spare Pair of Angle Brackets, Cat. No. 148 000 99A.  
Spare Pair of Wall Plates, Cat. No. 148 000 99B.

**FIG. 1106 - UTILITY HOOK**



**FIG. 1106**

**CONSTRUCTION:**

- \* **CHROME PLATED ZINC ALLOY**



**ORDERING INFORMATION**

Projection Inches	Width Base Inches	Dealer Pkg. 10 Cards 1 Pc. per Card	OEM Bulk Pkg. 50 Pcs.	Screw Size	Ship Wt. Carton Lbs. DP/OEM Bulk
3/4	1	1106 DP CHR	1106 000 CHR	6	1.1/2.8

**FIG. 975 - UTILITY HOOK**



**FIG. 975**

**CONSTRUCTION:**

- \* **CHROME PLATED ZINC ALLOY**



**ORDERING INFORMATION**

Projection Inches	Width Base Inches	Dealer Pkg. 10 Cards 1 Pc. per Card	OEM Bulk Pkg. 50 Pcs.	Screw Size	Ship Wt. Carton Lbs. DP/OEM Bulk
2	1-1/8	975 DP1 CHR	975 001 CHR	6	1.2/3.3
3	1-1/4	975 DP2 CHR	975 002 CHR	6	1.5/4.6

**FIG. 610 - UTILITY HOOK**



**FIG. 610**

**CONSTRUCTION:**

- \* **CHROME PLATED ZINC ALLOY**



**ORDERING INFORMATION**

Projection Inches	Width Base Inches	Dealer Pkg. 10 Cards 1 Pc. per Card	OEM Bulk Pkg. 50 Pcs.	Screw Size	Ship Wt. Carton Lbs. DP/OEM Bulk
1-3/8	1-1/8	610 DP CHR	610 000 CHR	6	0.8/2.2

## FASTENERS

### **Figs. 869, 896, 898, 901 & 907 - "DURABLE TYPE" FASTENERS**

#### **CONSTRUCTION:**

**Figs. 896, 898, 901 & 907 - NICKEL PLATED BRASS**  
**FIG. 869 - STAINLESS STEEL, 5/8 INCH SELF TAPPING SCREW**

For Canvas to Surface, Use Figs. 869, 896 and 898  
 For Canvas to Canvas, Use Figs. 896, 898, 901 & 907

#### **ORDERING INFORMATION**

Description	Standard	Ship Wt.
	Pkg. - 100 Pcs.	Carton Lbs.
	OEM Pkg. - 500 Pcs.	Std. Pkg/OEM Bulk
Stud	869 000 STS	0.7/3.8
Stud	901 000 NKL	0.2/1.1
Socket	898 000 NKL	0.4/2.2
Button	896 000 NKL	0.4/2.2
Eyelet	907 000 NKL	0.2/1.1

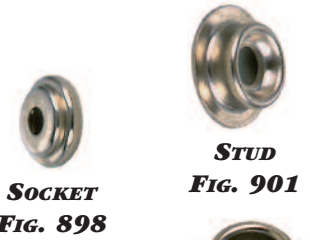

**SOCKET**  
**FIG. 898**

**STUD**  
**FIG. 901**

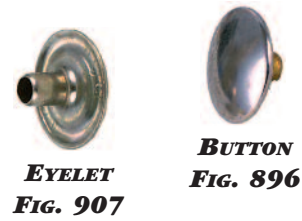

**EYELET**  
**FIG. 907**

**BUTTON**  
**FIG. 896**



**STUD**  
**FIG. 869**



### **Figs. 60, 62, 116, 117 & 118 - "LIFT TYPE" FASTENERS**

#### **CONSTRUCTION:**

**Figs. 60, 62, 116 & 118 - NICKEL PLATED BRASS**  
**FIG. 117 - STAINLESS STEEL, 1/2 INCH SELF TAPPING SCREW**

#### **ORDERING INFORMATION**

Description	Standard	Ship Wt.
	Pkg. - 100 Pcs.	Carton Lbs.
		Standard Pkg.
Clinch Stud	60 000 NKL	0.6
Clinch Washer	62 000 NKL	0.3
Clinch Plate	118 000 NKL	0.4
Stud	117 000 STS*	0.6
Socket	116 000 NKL	0.9

\*OEM Pkg. - 500 pcs.



**CLINCH STUD**  
**FIG. 60**

**CLINCH WASHER**  
**FIG. 62**



**STUD**  
**FIG. 117**

**SOCKET**  
**FIG. 116**



**CLINCH PLATE**  
**FIG. 118**



### **Figs. 994, 996 & 997 - CURTAIN FASTENERS**

#### **CONSTRUCTION:**

**\* NICKEL PLATED BRASS**

#### **ORDERING INFORMATION**

Description	Standard	Ship Wt.
	Pkg. - 100 Pcs.	Carton Lbs.
		Standard Pkg.
Flanged Stud	994 000 NKL	1.5
Eyelet	996 000 NKL	0.6
Washer	997 000 NKL	0.2

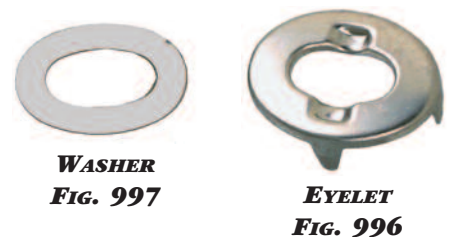

**WASHER**  
**FIG. 997**

**EYELET**  
**FIG. 996**



**FLANGED STUD**  
**FIG. 994**



## CONVERTIBLE TOP FITTINGS, UTILITY HOOK & BOAT COVER SOCKETS



**SOCKET**  
FIG. 395#3



**SLIDE**  
FIGS. 395#6 & 395 #8



**SIDE PLATE**  
FIG. 395#8



**HINGE**  
FIGS. 395#1 & 395 #H



**EYE END**  
FIGS. 395#5 & 395#9

### FIG. 395 - CONVERTIBLE TOP FITTINGS

- CONSTRUCTION:**  
 \* CHROME PLATED ZINC ALLOY  
 \* STAINLESS STEEL SCREWS



### ORDERING INFORMATION

Description	Dealer Pkg. 5 Cards 2 Pcs. per Card	OEM Bulk Pkg. 100 Pcs.	Screw Size	Ship Wt. Carton Lbs. DP/OEM Bulk
Hinge for 3/4" fittings	395 DP1 CHR	395 001 CHR	8	1.6/14.0
Socket for 3/4" tubing	395 DP3 CHR	395 003 CHR	---	1.6/14.0
Eye End for 3/4" tubing with .049" wall	395 DP5 CHR	395 005 CHR*	---	1.0/8.1
Slide for 3/4" tubing	395 DP6 CHR	395 006 CHR	---	1.7/14.9
Side Mounting Plate	395 DP8 CHR	395 008 CHR	10	1.0/8.1
Eye End for 7/8" tubing	395 DP9 CHR	395 009 CHR	---	1.5/13.2
Slide for 7/8" tubing	395 DPS CHR	395 010 CHR**	---	2.8/11.9
Hinge for 7/8" fittings	395 DPH CHR	395 011 CHR**	8	2.6/11.9

\*OEM Bulk Pkg. - 200 pcs.  
 \*\*OEM Bulk Pkg. - 50 pcs.



### FIG. 1249 - UTILITY HOOK



FIG. 1249

- CONSTRUCTION:**  
 \* CHROME PLATED ZINC ALLOY



### ORDERING INFORMATION

Length Overall Inches	Width Overall Inches	Inside Hook Inches	Dealer Pkg. 10 Cards 5 Pcs. per Card	OEM Bulk Pkg. 100 Pcs.	Screw Size	Ship Wt. Carton Lbs. DP/OEM Bulk
15/16	1/2	1/4	1249 DP CHR	1249 000 CHR	6	1.0/1.5



Cabinet Hardware

### FIG. 578 - BOAT COVER SOCKETS



FIG. 578

- CONSTRUCTION:**  
 \* CHROME PLATED ZINC ALLOY  
 Will Accommodate 3/8 Inch Wood or  
 Plastic Battens Up To 1-3/4 Inches Wide



### ORDERING INFORMATION

Length Overall Inches	Dimensions Opening Inches	Width Overall Inches	Dealer Pkg. 10 Cards 1 Pair per Card	Screw Size	Ship Wt. Carton Lbs. Dealer Pkg.
3-1/4	1-7/8 x 7/16	5/8	578 DP CHR	6	2.0





## OUTRIGGER POLE HOLDERS

**FIG. 445 - OUTRIGGER POLE HOLDERS**

**CONSTRUCTION:**

- \* **STAINLESS STEEL MAIN TUBE**
- \* **CHROME PLATED BRASS YOKE TUBING AND BRONZE FITTINGS**

A large knob on the sliding clamp provides ready adjustment for all fishing positions. A stainless steel drift pin in the sliding clamp is pulled to release the pole holder to a down and aft position. Features include heavy bi-directional hinged mounting base for easy installation on a horizontal or vertical surface. A stop collar (Fig. No. 415) is included for presetting the desired fishing angle. Sturdy folding lay down hooks (Fig. No. 410) are also included for supporting the outriggers in the down position. The mounting yokes may be installed in an inverted position, rather than that shown, to accommodate various installation requirements.

**ORDERING INFORMATION**

Holder Size No.	I.D. Main Tube Inches	"A" Length Main Tube Inches	O.D. Main Tube Inches	Standard Pkg. - 1 Pair	"B" Yoke Width Inches	Ship Wt. Carton Lbs. Standard Pkg.	Bolt Size Inches
1	1.500	20	1-5/8	445 001 CHR	11-3/4	22.1	1/4
2	1.900	20	2	445 002 CHR	11-3/4	22.6	1/4
3	1.900	35	2	445 003 CHR	24	32.3	1/4

Size No. 1 For Use With Outrigger Poles Cat. Nos. 1798 016 ALU and 1798 018 ALU.

Size No. 2 For Use With Outrigger Poles Cat. No. 1798 019 ALU.

Size No. 3 For Use With Outrigger Poles Cat. No. 1798 019 ALU.

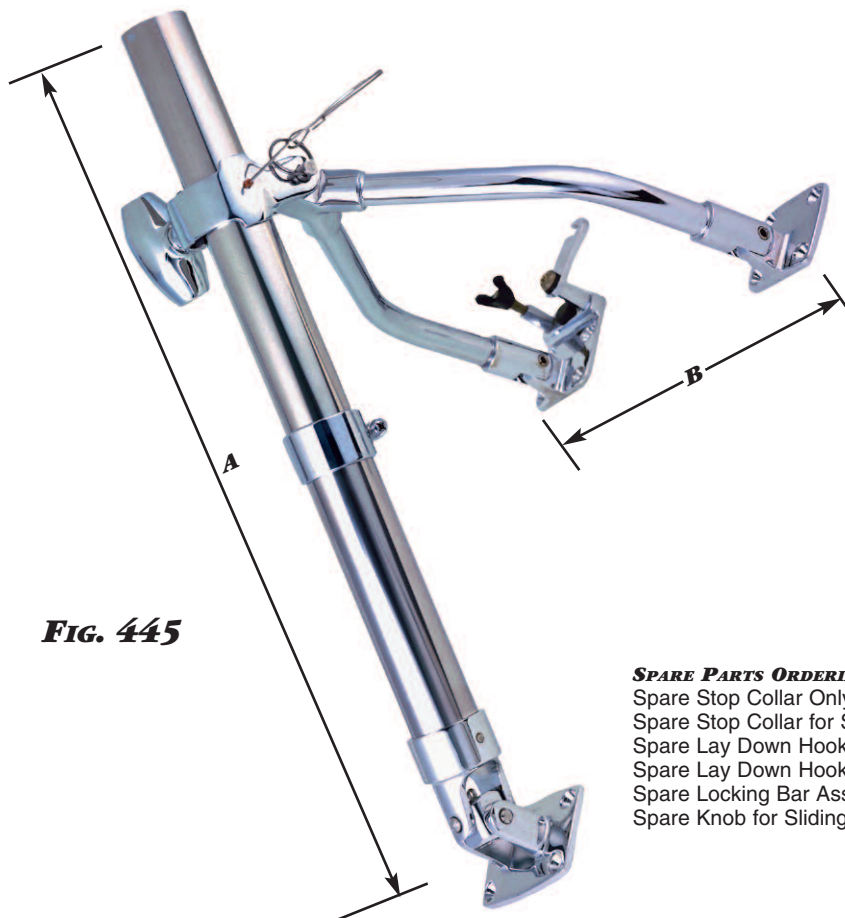

**FIG. 445**

Sizes 1 and 2 feature a retaining bar on one mounting bracket (as illustrated) to hold the outrigger in the vertical position.

Size 3 features a standard hinged holding bracket (Fig. No. 408) for quick release of the main tube.



**FIG. 408**

**FIG. 410**

**FIG. 415**

**SPARE PARTS ORDERING INFORMATION**

- Spare Stop Collar Only for Size 1 Holder, Cat. No. 415 001 CHR.
- Spare Stop Collar for Size 2 and 3 Holders, Cat. No. 415 002 CHR.
- Spare Lay Down Hook for Size 1 Holder, Cat. No. 410 001 CHR.
- Spare Lay Down Hook for Size 2 and 3 Holders, Cat. No. 410 002 CHR.
- Spare Locking Bar Assembly with Stud, Cat. No. 406 000 99A.
- Spare Knob for Sliding Clamp Assembly, Cat. No. 401 000 CHR.

## OUTRIGGER POLE HOLDERS

**FIG. 470 - OUTRIGGER POLE HOLDERS**

**CONSTRUCTION:**

- \* **STAINLESS STEEL MAIN TUBE**
- \* **CHROME PLATED BRASS YOKE TUBING AND BRONZE FITTINGS**

A large knob on the sliding clamp provides ready adjustment for all fishing positions. A stainless steel drift pin in the sliding clamp is pulled to release the pole holder to a down and aft position. Features include a heavy swivel mounting base for easy installation on a horizontal or vertical surface. A stop collar (Fig. No. 415) is included for presetting the desired fishing angle. Sturdy folding lay down hooks (Fig. No. 410) are also included for supporting the outriggers in the down position. The mounting yokes may be installed in an inverted position, rather than that shown, to accommodate various installation requirements.

**ORDERING INFORMATION**

Holder Size No.	I.D. Main Tube Inches	"A" Length Main Tube Inches	O.D. Main Tube Inches	Standard Pkg. - 1 Pair	"B" Yoke Width Inches	Ship Wt. Carton Lbs. Standard Pkg.	Bolt Size Inches
1	1.500	20	1-5/8	470 001 CHR	11-3/4	22.9	1/4
2	1.900	20	2	470 002 CHR	11-3/4	24.4	1/4
3	1.900	35	2	470 003 CHR	24	33.9	1/4

Size No. 1 For Use With Outrigger Poles Cat. Nos. 1798 016 ALU and 1798 018 ALU.

Size No. 2 For Use With Outrigger Poles Cat. No. 1798 019 ALU.

Size No. 3 For Use With Outrigger Poles Cat. No. 1798 019 ALU.

Sizes 1 and 2 feature a retaining bar on one mounting bracket (as illustrated) to hold the outrigger in the vertical position.

Size 3 features a standard hinged holding bracket (Fig. No. 408) for quick release of the main tube.



**SPARE PARTS ORDERING INFORMATION**

- Spare Stop Collar Only for Size 1 Holder, Cat. No. 415 001 CHR.
- Spare Stop Collar for Size 2 and 3 Holders, Cat. No. 415 002 CHR.
- Spare Lay Down Hook for Size 1 Holder, Cat. No. 410 001 CHR.
- Spare Lay Down Hook for Size 2 and 3 Holders, Cat. No. 410 002 CHR.
- Spare Locking Bar Assembly with Stud, Cat. No. 406 000 99A.
- Spare Knob for Sliding Clamp Assembly, Cat. No. 401 000 CHR.

## OUTRIGGER POLE HOLDERS

**REMOVABLE TUBES LIFT AND TURN TO THREE POSITIONS: VERTICAL, FISHING AND LOWERED  
UNIVERSAL TUBES MAY BE USED ON EITHER SIDE  
SUPPLIED IN PAIRS CONSISTING OF TWO MOUNTS AND TWO TUBES**

### FIG. 444 - SIDE MOUNT OUTRIGGER POLE HOLDERS

**CONSTRUCTION:**

- \* CHROME PLATED BRONZE BRACKETS
- \* SIZE 1 TUBES ARE POLISHED STAINLESS STEEL
- \* SIZE 2 TUBES ARE CHROME PLATED BRASS



Holder Size No.	I.D. Tube Inches	O.D. Tube Inches	Dimensions Bracket Inches	Dealer Pkg. 5 Pkgs. 1 Pair per Pkg.	Standard Pkg. - 1 Pair	Ship Wt. Carton Lbs. DP/Std. Pkg.
1	1.120	1-1/4	4-1/2 x 3	444 DP1 CHR	-----	21.2/--
2	1.500	1-5/8	6-1/2 x 4	-----	444 002 CHR	--/8.5

Size 1 Bolt Size - 1/4".      Size 2 Bolt Size - 5/16".  
Spare Bracket For Size No. 1, Cat. No. 478 001 CHR.  
Spare Bracket For Size No. 2, Cat. No. 478 002 CHR.  
See Fig. 451 for Outrigger Designations and Spare Tube Ordering.



FIG. 444

### FIG. 451 - DECK MOUNT OUTRIGGER POLE HOLDERS

**CONSTRUCTION:**

- \* CHROME PLATED BRONZE PLATES
- \* SIZE 1 TUBES ARE POLISHED STAINLESS STEEL
- \* SIZE 2 TUBES ARE CHROME PLATED BRASS



**ORDERING INFORMATION**

Holder Size No.	I.D. Tube Inches	O.D. Tube Inches	Dimensions Bracket Inches	Dealer Pkg. 5 Pkgs. 1 Pair per Pkg.	Standard Pkg. - 1 Pair	Ship Wt. Carton Lbs. DP/Std. Pkg.
1	1.120	1-1/4	5 x 2-1/2	451 DP1 CHR	-----	30.0/--
2	1.500	1-5/8	6 x 3-1/2	-----	451 002 CHR	--/10.5

Size 1 Bolt Size - 1/4".      Size 2 Bolt Size - 5/16".  
Spare Tube Only For Figs. 444 & 451 Size 1, Cat. No. 479 DP1 STS.      Spare Plate Only for Size No. 1, Cat. No. 474 001 CHR.  
Spare Tube Only For Figs. 444 & 451 Size 2, Cat. No. 479 002 CHR.      Spare Plate Only for Size No. 2, Cat. No. 474 002 CHR.  
Size No. 1 For Use With Outrigger Poles Cat. Nos. 476 015 ALU and 1798 015 ALU.  
Size No. 2 For Use With Outrigger Poles Cat. Nos. 1798 016 ALU and 1798 018 ALU.



FIG. 451

### FIG. 1314 - DECK MOUNT OUTRIGGER POLE HOLDERS

**CONSTRUCTION:**

- \* CHROME PLATED ZINC ALLOY PLATES
- \* STAINLESS STEEL TUBES

**IMPROVED FOR USE WITH ALUMINUM OUTRIGGER POLES,  
CAT. NOS. 1798 015 ALU AND 476 015 ALU**



**ORDERING INFORMATION**

I.D. Tube Inches	O.D. Tube Inches	Dimensions Bracket Inches	Dealer Pkg. 5 Pkgs. 1 Pair per Pkg.	OEM Bulk Pkg. 10 Pair	Bolt Size Inches	Ship Wt. Carton Lbs. DP/OEM Bulk
1.120	1-1/4	5 x 2-1/2	1314 DP CHR	1314 000 CHR	1/4	21.5/38.7

Spare Tube Only, Cat. No. 479 DP1 STS.      Spare Plate Only, Cat. No. 1320 000 CHR.



FIG. 1314

## OUTRIGGER POLES & SPREADERS

**FIG. 1798 - OUTRIGGER POLES**

**CONSTRUCTION:**

**\* SILVER ANODIZED ALUMINUM  
WITH BLACK PLASTIC INSULATED BASE**

Sizes 15 Through 19 Have Standard (Fig. No. 468) Line Guides,  
and All Sizes Have Roller Tip (Fig. No. 471) Line Guides

Heavy Duty Poles For Rough Water Use.

Sizes 15 Through 19 Have Sections Threaded For Easy Assembly

**ORDERING INFORMATION**

"A" Length Overall Feet	"B" Base Diameter Inches	Number Of Sections	Standard Pkg. 1 Pair Cat. No.	Single Pole Only Cat. No.	Ship Wt. Carton Lbs. Std. Pkg.
15	1.120	4	1798 015 ALU	1798 015 99A	8.5
15	1.500	4	1798 016 ALU	1798 016 99A	11.0
18-2/3	1.500	5	1798 018 ALU	1798 018 99A	14.0
18-2/3	1.900	5	1798 019 ALU	1798 019 99A	14.7

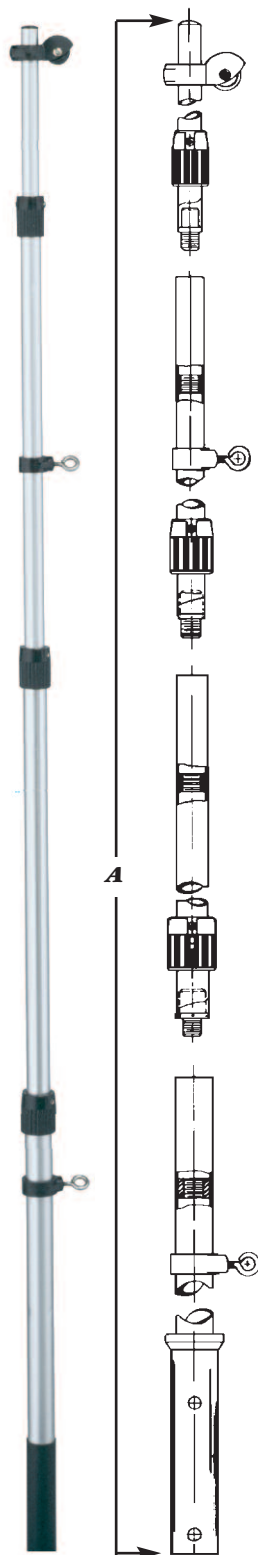

**FIG. 1798**

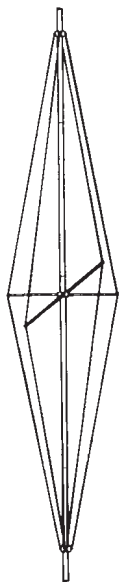

**FIG. 1714**

**FIG. 1714 - SPREADERS**

**CONSTRUCTION:**

**\* ANODIZED ALUMINUM, SILVER FINISH  
\* SPREADER ARMS AND EYE BANDS**

Designed For Use With Our Aluminum  
Outrigger Poles When Maximum Rigidity is Desired  
Spreaders Are Suggested For Use On  
18 and 19 Foot Outrigger Poles

Supplied in Pairs, Consisting of Spreaders,  
Stainless Steel Cable, Eye Bands and Turnbuckles

**ORDERING INFORMATION**

For Use With Outrigger Poles Catalog Numbers	Silver Single Spreader Standard Pkg. - 1 Pair	Ship Wt. Carton Lbs. Standard Package
1798 018 ALU	1714 018	4.4
1798 019 ALU	1714 018	4.4

## OUTRIGGER POLE KIT, LINE GUIDES & TROLLING PIN

### FIG. 476 - 15' OUTRIGGER POLE KIT

**CONSTRUCTION:**

\* **ALUMINUM**

One Pair of Fig. No. 1798 015 Aluminum Poles, Guides and Clips Included.

For Use With Fig. Nos. 444 DP1 CHR, 451 DP1 CHR and 1314 DP CHR Holders

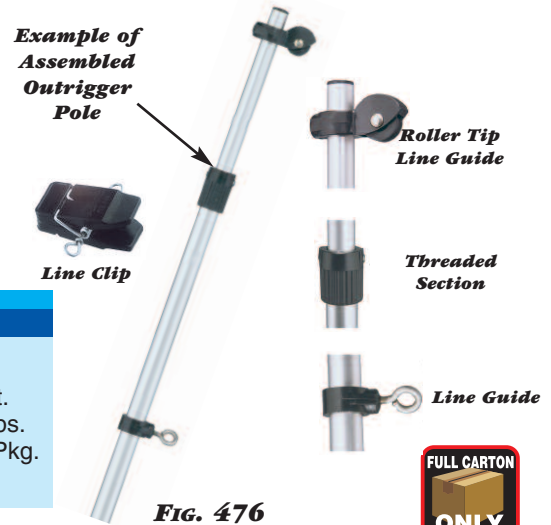

FIG. 476



**ORDERING INFORMATION**

Open Length Overall Feet	O.D. Base Inches	Number of Sections	Standard Pkg. 1 Kit per Box	Ship Wt. Carton Lbs. Standard Pkg.
15	1.120	4	476 015 ALU	8.3

Spare Pole Only, Cat. No. 1798 015 99A.

### FIG. 471 - OUTRIGGER POLE ROLLER TIP LINE GUIDES

**CONSTRUCTION:**

\* **HIGH IMPACT BLACK PLASTIC**

\* **7/8 INCH O.D. NYLON SHEAVE**



**ORDERING INFORMATION**

I.D. Body Inches	For Use With Outrigger Pole Size	Maximum Rope Size Inches	Dealer Pkg. 5 Cards 1 Pair per Card	Ship Wt. Carton Lbs. Dealer Pkg.
9/16	-----	1/4	471 DP1 BLK	0.9
5/8	1798 015	1/4	471 DP2 BLK	0.9
3/4	1798 016 thru 019	1/4	471 DP3 BLK	0.8



FIG. 471



### FIG. 468 - OUTRIGGER POLE LINE GUIDES

**CONSTRUCTION:**

\* **HIGH IMPACT BLACK PLASTIC**

\* **3/8 INCH I.D. STAINLESS STEEL EYE**



**ORDERING INFORMATION**

I.D. Body Inches	Dealer Pkg. - 5 Cards 2 Pcs. per Card	Ship Wt. Carton Lbs. Dealer Pkg.
9/16	468 DP1 BLK	0.4
5/8	468 DP2 BLK	0.4
3/4	468 DP3 BLK	0.5
1	468 DP4 BLK	0.5
1-3/16	468 DP5 BLK	0.6
1-5/8	468 DP6 BLK	0.7



FIG. 468



### FIG. 469 - OUTRIGGER TROLLING PIN OR CLIP

**CONSTRUCTION:**

\* **HIGH IMPACT BLACK PLASTIC**

\* **STAINLESS STEEL EYES AND SPRING**



**ORDERING INFORMATION**

Dimensions Inches	Dealer Pkg. - 5 Cards 2 Pcs. per Card	Ship Wt. Carton Lbs. Dealer Pkg.
2-3/4 x 1-3/8	469 DP BLK	1.9



FIG. 469



## FISHING ROD HOLDERS

### FIG. 447 - FISHING ROD HOLDERS



Fig. 447



Fig. 447 D01 & DPD with Drain Bib



- VERTICAL FLUSH MOUNT**
- CONSTRUCTION:**
- \* CHROME PLATED BRONZE FLANGE
  - \* STAINLESS STEEL TUBE
  - \* HARD BLACK PLASTIC LINER
  - \* INTEGRAL FLIP-UP CAP

D01 & DPD - Includes a Drain Bib for 5/8 Inch I.D. Flexible Hose



#### ORDERING INFORMATION

Mount Type	Drain Bib	I.D. Tube Inches	O.D. Tube Inches	Length Under Flange Inches	Dimensions Flange Inches	Dealer Pkg. 5 Pkgs. 1 Pc. per Pkg.	OEM Bulk Pkg. 10 Pcs.	Bolt Size	Ship Wt. Carton Lbs. DP/OEM Bulk
Vertical	No	1-5/8	2	9	3-1/2 O.D.	447 DP1 CHR	447 001 CHR	10	8.2/14.8
Vertical	Yes	1-5/8	2	10-1/2	3-1/2 O.D.	447 DPD CHR	447 D01 CHR	10	8.2/14.8



Fig. 448-D01 ILLUSTRATED



Fig. 448 D01 & DPD With Drain Bib

### FIG. 448 - FISHING ROD HOLDERS

#### ANGLED FLUSH MOUNT (APPROXIMATE 65°)

- CONSTRUCTION:**
- \* CHROME PLATED BRONZE FLANGE
  - \* CHROME PLATED BRASS TUBE

Fig. 448 No. 1 - Soft Black Liner and Flange Gasket with Integral Flip-up Cap  
D01 & DPD - Includes a Drain Bib for 5/8 Inch I.D. Flexible Hose  
001 & DP1 Without Drain Bib

Fig. 448 No. 2 - Soft Black Liner with Lip Only



#### ORDERING INFORMATION

Mount Type	Drain Bib	I.D. Tube Inches	O.D. Tube Inches	Length Under Flange Inches	Dimensions Flange Inches	Dealer Pkg. 5 Pkgs. 1 Pc. per Pkg.	OEM Bulk Pkg. 10 Pcs.	Bolt Size	Ship Wt. Carton Lbs. DP/OEM Bulk
Angled	No	1-5/8	2	8	4-1/4 x 3-1/2	448 DP1 CHR	448 001 CHR	1/4	10.3/19.9
Angled	Yes	1-5/8	2	9-1/2	4-1/4 x 3-1/2	448 DPD CHR	448 D01 CHR	1/4	--/19.9
Angled	No	1-7/8	2-1/4	12	4-7/8 x 4	448 DP2 CHR*	-----	1/4	3.5/--

\*Dealer Pkg. - 1 card, 1 Pc. per card.

### FIG. 452 - FISHING ROD HOLDER

#### ANGLED FLUSH MOUNT (APPROXIMATE 65°)

- CONSTRUCTION:**
- \* POLISHED STAINLESS STEEL FLANGE
  - \* STAINLESS STEEL TUBE
  - \* SOFT BLACK LINER
  - \* FLANGE GASKET WITH INTEGRAL FLIP-UP CAP

D01 & DPD - Includes a Drain Bib for 5/8 Inch I.D. Flexible Hose



Fig. 452 D01 & DPD with Drain Bib



Fig. 452

#### ORDERING INFORMATION



Mount Type	Drain Bib	I.D. Tube Inches	O.D. Tube Inches	Length Under Flange Inches	Dimensions Flange Inches	Dealer Pkg. 5 Pkgs. 1 Pc. per Pkg.	OEM Bulk Pkg. 20 Pcs.	Ship Wt. Carton Lbs. DP/OEM Bulk
Angled	No	1-5/8	2	8-1/4	4-1/8 x 3-3/8	452 DP STS	452 000 STS	6.7/12.4
Angled	Yes	1-5/8	2	9-3/4	4-1/8 x 3-3/8	452 DPD STS	452 D01 STS	6.7/12.4

Bolt Size #10.

Rounded Rod Holder Bottom



#### SPARE PARTS ORDERING INFORMATION

Spare Liner with Lip and Tube, See Fig. 482 DP, Specify Size, Page 202.

Spare Cap and Gasket Kit, See Figs. 480 DP and 481 DP, Page 202.

Spare Cap and Gasket Kit for Fig. 447, Cat No. 484 DP BLK, Page 202.

## FISHING ROD HOLDERS

**FIG. 1205 - FISHING ROD HOLDER**

**ANGLED FLUSH MOUNT (APPROXIMATE 65°)**

**CONSTRUCTION:**

- \* CHROME PLATED ZINC ALLOY FLANGE
- \* ANODIZED ALUMINUM TUBE
- \* SOFT BLACK LINER

- \* FLANGE GASKET WITH INTEGRAL FLIP-UP CAP

D01 & DPD- Includes a Drain Bib for 5/8 Inch I.D. Flexible Hose

Fig. 1205 D01 & DPD with Drain Bib

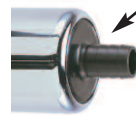

Rounded Rod Holder Bottom



**FIG. 1205**



**ORDERING INFORMATION**

	I.D. Tube	O.D. Tube	Length Under Flange	Dimensions Flange	Dealer Pkg. 5 Pkgs. 1 Pc. per Pkg.	OEM Bulk Pkg. 20 Pcs.	Ship Wt. Carton Lbs. DP/OEM Bulk
Angled No	1-5/8	2	8	4-1/4 x 3-1/2	1205 DP CHR	1205 000 CHR	8.2/29.0
Angled Yes	1-5/8	2	9-1/2	4-1/4 x 3-1/2	1205 DPD CHR	1205 D01 CHR	8.2/29.0

Bolt Size 1/4".

**FIG. 1099 - FISHING ROD HOLDER**

**SIDE MOUNT**

**CONSTRUCTION:**

- \* STAINLESS STEEL TUBE
- \* CHROME PLATED BRASS BRACKETS
- \* HARD BLACK PLASTIC LINER



Rounded Rod Holder Bottom



**ORDERING INFORMATION**

I.D. Tube	O.D. Tube	Length Overall	Width Bracket	Dealer Pkg. 5 Pkgs. 1 Pc. per Pkg.	Ship Wt. Carton Lbs. Dealer Pkg.
1-5/8	2	9	3	1099 DP STS	6.2

Mounting Screw Size #8 R.H.  
Spare Bracket, Cat. No. 1107 000 CHR.

NOTE: The use of a safety line attached to the rod and reel is recommended, particularly when running or fishing with heavy duty rods and reels.

**FIG. 1099**



**FIG. 1100 - FISHING ROD HOLDER**

**SIDE MOUNT**

**CONSTRUCTION:**

- \* CHROME PLATED BRASS TUBE & BRACKETS
- \* HARD BLACK PLASTIC LINER



Rounded Rod Holder Bottom



**ORDERING INFORMATION**

I.D. Tube	O.D. Tube	Length Overall	Width Bracket	Dealer Pkg. 5 Pkgs. 1 Pc. per Pkg.	Ship Wt. Carton Lbs. Dealer Pkg.
1-5/8	2	9	3	1100 DP CHR	6.7

Bolt Size #8 R.H.  
Spare Bracket, Cat. No. 1107 000 CHR.

NOTE: The use of a safety line attached to the rod and reel is recommended, particularly when running or fishing with heavy duty rods and reels.

**FIG. 1100**



## FISHING ROD HOLDERS

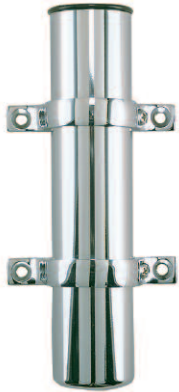

**Fig. 404 #1**



Size #1  
Rounded  
Rod Holder  
Bottom

### SIDE MOUNT

#### CONSTRUCTION:

\* **CHROME PLATED BRASS AND BRONZE**

**SIZE #1 WITH HARD BLACK PLASTIC LINER**

**SIZE #2 SOFT BLACK LIP & LINER**



**Fig. 404 #2**

#### ORDERING INFORMATION



I.D. Tube Inches	O.D. Tube Inches	Length Overall Inches	Width Bracket Inches	Dealer Pkg. - 5 Pkgs. 1 Pc. per Pkg.	Ship Wt. Carton Lbs. Dealer Pkg.
1-5/8	2	9	4-3/16	404 DP1 CHR	10.5
1-7/8	2-1/4	11	4-3/4	404 DP2 CHR*	3.3

Bolt Size 1/4".

\* Dealer Pkg. - 1 card, 1 Pc. per card.

Spare Bracket for Size No. 1, Cat. No. 404 001 99A.

Spare Bracket for Size No. 2, Cat. No. 404 002 99A.

Spare Liner with Lip and Tube for Size #2 See Fig. 483 DP2 BLK on Page 202.

NOTE: The use of a safety line attached to the rod and reel is recommended, particularly when running or fishing with heavy duty rods and reels.

### FIG. 1104 - FISHING ROD HOLDER

#### SIDE MOUNT

#### CONSTRUCTION:

\* **BLACK PLASTIC**

\* **CHROME PLATED BRASS BRACKETS**



**Fig. 1104**

#### ORDERING INFORMATION



I.D. Tube Inches	O.D. Tube Inches	Length Overall Inches	Width Bracket Inches	Dealer Pkg. - 5 Pkgs. 1 Pc. per Pkg.	Ship Wt. Carton Lbs. Dealer Pkg.
1-5/8	2	9	3-1/4	1104 DP BLK	3.3

Bolt Size #8 R.H.

Spare Bracket, Cat. No. 1107 000 CHR.

NOTE: The use of a safety line attached to the rod and reel is recommended, particularly when running or fishing with heavy duty rods and reels.



## FISHING ROD HOLDERS

### FIG. 1118 - CLAMP ON FISHING ROD HOLDERS

#### CONSTRUCTION:

- \* CHROME PLATED BRASS AND BRONZE
- \* HARD BLACK PLASTIC LINER

- \* CLAMP-ON FEATURE ELIMINATES DRILLING RAIL AND SIMPLIFIES RELOCATION.

- \* MOUNTS ON VERTICAL OR HORIZONTAL RAILS

- \* DP FOR RAILS 3/4 TO 1 INCH IN DIAMETER.

- ADJUSTABLE AS SUPPLIED FOR 7/8 TO 1 INCH RAILS

- ADAPTABLE TO 3/4 INCH RAILS BY REDUCING THE MOUNTING BOLT LENGTH



- \* DP2 FITS 1-1/4" DIAMETER RAILS

#### ORDERING INFORMATION

For Rail Size Diameter	I.D. Tube Inches	O.D. Tube Inches	Length Overall Inches	Dealer Pkg. 5 Pcs.	Ship Wt. Carton Lbs. Dealer Pkg.
3/4 to 1	1-5/8	2	9	1118 DP CHR	11.1
1-1/4	1-5/8	2	9	1118 DP2 CHR	11.1

Spare Face Plate with Bolts, Cat. No. 1118 000 99A.

Spare Intermediate Plate, Cat. No. 1118 000 99B.

NOTE: The use of a safety line attached to the rod and reel is recommended,



FIG. 1118 FOR 3/4" TO 1" DIA. RAILS

FIG. 1118 DP2 CHR FOR 1-1/4" DIA. RAILS

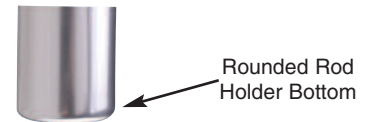

### FIG. 1215 - CLAMP ON FISHING ROD HOLDERS

#### CONSTRUCTION:

- \* CHROME PLATED ZINC ALLOY
- \* POLISHED STAINLESS STEEL TUBE
- \* HARD BLACK PLASTIC LINER

- \* CLAMP-ON FEATURE ELIMINATES DRILLING RAIL AND SIMPLIFIES RELOCATION

- \* MOUNTS ON VERTICAL OR HORIZONTAL RAILS

- \* DP FOR RAILS 3/4 TO 1 INCH IN DIAMETER.

- ADJUSTABLE AS SUPPLIED FOR 7/8 TO 1 INCH RAILS

- ADAPTABLE TO 3/4 INCH RAILS BY REDUCING THE MOUNTING BOLT LENGTH



- \* DP2 FITS 1-1/4" DIAMETER RAILS

#### ORDERING INFORMATION

For Rail Size Diameter	I.D. Tube Inches	O.D. Tube Inches	Length Overall Inches	Dealer Pkg. 5 Pcs.	Ship Wt. Carton Lbs. Dealer Pkg.
3/4 to 1	1-5/8	2	9	1215 DP CHR	8.9
1-1/4	1-5/8	2	9	1215 DP2 CHR	8.9

Spare Face Plate with Bolts, Cat. No. 1215 DP 99A.

Spare Intermediate Plate, Cat. No. 1215 000 99B.

NOTE: The use of a safety line attached to the rod and reel is



FIG. 1215 FOR 3/4" TO 1" DIA. RAILS

FIG. 1215 DP2 CHR FOR 1-1/4" DIA. RAILS

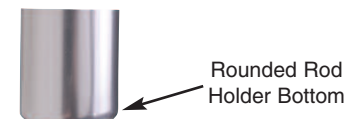

## FISHING ROD HOLDER, CAP & GASKET KITS AND LINERS, LIPS & TUBES

**FIG. 449 - REMOVABLE FISHING ROD HOLDER**



**FIG. 449**

**CONSTRUCTION:**

- \* CHROME PLATED BRASS AND MANGANESE BRONZE
- \* SOFT BLACK LINER

**DESIGNED FOR VERTICAL MOUNTING, THIS HOLDER IS EASILY REMOVED WHEN NOT IN USE, LEAVING NO PROJECTING HARDWARE**



**ORDERING INFORMATION**

I.D. Tube Inches	O.D. Tube Inches	Dimensions Bracket Inches	Dealer Pkg. - 1 Card 1 Pc. per Card	Ship Wt. Carton Lbs. Dealer Pkg.
1-5/8	2	4 x 3-3/4	449 DP CHR	3.0

Screw Size #10.

Spare Holder Only, Cat. No. 449 000 99A. Spare Bracket Only, Cat. No. 449 000 99B. Spare Liner with Lip and Tube, Cat. No. 483 DP1 BLK.

**FIGS. 480, 481 & 484 - CAP AND GASKET KITS**



**FIG. 480**

**CONSTRUCTION:**

- \* SOFT BLACK FLANGE GASKET WITH INTEGRAL FLIP-UP CAP
- \* SOFT BLACK LIP

**REPLACEMENT OR UPGRADE FOR OLDER HOLDERS**



**ORDERING INFORMATION**

To Fit Catalog Number	Dealer Pkg. - 5 Cards 1 Kit per Card	Ship Wt. Carton Lbs. Dealer Pkg.
448 DP1 CHR	480 DP BLK	1.8
1205 DP CHR	480 DP BLK	1.8
452 DP STS	481 DP BLK	1.6
447 DP1 CHR	484 DP BLK	1.0



**FIG. 482**

**FIG. 483**

**FIGS. 482 & 483 - LINERS, LIPS AND TUBES**

**FOR FISHING ROD HOLDERS**

Except Fig. Nos. 404 #1, 447, 1099, 1100, 1104, 1118 and 1215



**ORDERING INFORMATION**

I.D. Inches	For Angled Flush Mount Complete Dealer Pkg. - 5 Cards 1 Set per Card	For All Others Complete Dealer Pkg. - 5 Cards 1 Set per Card	Spare Lip Only For Fig. 482 Dealer Pkg. - 5 Cards 1 Pc. per Card	Spare Lip Only For Fig. 483 Dealer Pkg. - 5 Cards 1 Pc. per Card
1-5/8	482 DP1 BLK	483 DP1 BLK	482 DP1 99A	483 DP1 99A
1-7/8	482 DP2 BLK	483 DP2 BLK	482 DP2 99A	483 DP2 99A



## NUMERICAL INDEX

<b>FIG. No.</b>	<b>PAGE No.</b>	<b>FIG. No.</b>	<b>PAGE No.</b>	<b>FIG. No.</b>	<b>PAGE No.</b>	<b>FIG. No.</b>	<b>PAGE No.</b>	<b>FIG. No.</b>	<b>PAGE No.</b>
4D.....	37 & 57	159.....	103	297.....	45	434.....	137	543.....	120
4F.....	37 & 57	162.....	98	298.....	45	435.....	61	544.....	133
5D.....	37 & 57	163.....	96	300.....	88	440.....	61	545.....	133
5F.....	37 & 57	164.....	96	301.....	115	441.....	98	550.....	100
7D.....	37 & 57	165.....	96	303.....	60	444.....	195	554.....	168
7F.....	37 & 57	166.....	102	305.....	62	445.....	193	555.....	89
24.....	46	170.....	10,15,16, 30,31,32 & 33	309.....	40 & 59	447.....	198	556.....	126
42.....	95	171.....	102	313.....	62	448.....	198	557.....	122
52.....	46	172.....	102	314.....	62	449.....	202	558.....	94
60.....	191	179.....	103	315.....	99	451.....	195	559.....	168
62.....	191	196.....	96	318.....	86	452.....	198	561.....	128
63.....	112	197.....	163	322.....	114	454.....	58	562.....	145
64.....	6	200.....	7, 34 & 35	323.....	117	455.....	21	565.....	147
65.....	108	201.....	45	325.....	145	456.....	105	566.....	132
66.....	108	212.....	157	326.....	118	457.....	105	567.....	182
67.....	47 & 97	217.....	83	327.....	117	461.....	98	570.....	128
68.....	32	218.....	142	328.....	115	465.....	102	571.....	128
69.....	47	219.....	142	329.....	36	466.....	21	572.....	131
70.....	47 & 97	220.....	142	330.....	100	468.....	197	574.....	167
71.....	47	221.....	142	331.....	114	469.....	197	575.....	186
72.....	47	222.....	35	333.....	117	470.....	194	576.....	122
74.....	45	223.....	83	334.....	101	471.....	197	577.....	121
75.....	118	227.....	3 & 45	335.....	101	474.....	195	578.....	192
76.....	112	228.....	11 & 45	336.....	101	476.....	197	602.....	8
82.....	153	229.....	3 & 45	337.....	47 & 101	477.....	30 & 144	608.....	137
86.....	108	232.....	11 & 45	338.....	47	478.....	195	610.....	190
93.....	34	233.....	151	339.....	99	479.....	195	634.....	147
95.....	34	236.....	138	340.....	47 & 97	480.....	202	688.....	94
106.....	60	237.....	138	341.....	56	481.....	202	697.....	155
107.....	13	238.....	45	342.....	60	482.....	202	701.....	94
108.....	36 & 40	239.....	45	343.....	117	483.....	202	707.....	100
109.....	36	240.....	45	344.....	141	484.....	202	708.....	98
110.....	36	241.....	45	347.....	60	492.....	144	709.....	109
111.....	36	244.....	88	348.....	114	493.....	106	710.....	176 & 177
112.....	40 & 59	245.....	88	349.....	98	495.....	142	711.....	176 & 177
113.....	102	247.....	45	350.....	113	499.....	119	712.....	176 & 177
114.....	4 & 12	248.....	45	351.....	141	500.....	106	714.....	110
116.....	191	249.....	60	354.....	63	501.....	141	719.....	189
117.....	191	250.....	36	355.....	63	502.....	144	721.....	109
118.....	191	252.....	4	357.....	139	503.....	129	722.....	109
119.....	135	253.....	12	361.....	116	504.....	119	730.....	176 & 177
120.....	10,15,16, 30,32,33, & 163	254.....	9	362.....	41	505.....	129	731.....	176 & 177
123.....	96	256.....	60	363.....	110	506.....	128	732.....	146
124.....	109	257.....	89	365.....	118	507.....	127	737.....	110
125.....	21	258.....	157	367.....	60	509.....	129	742.....	110
126.....	125	259.....	45 & 60	370.....	110	510.....	99	750.....	136
127.....	102	260.....	45	371.....	41	513.....	123	752.....	137
131.....	37 & 57	261.....	45 & 60	373.....	60	514.....	94	753.....	89
132.....	89	265.....	87	374.....	60	515.....	129	754.....	146
133.....	58	266.....	110	375.....	47	517.....	94	757.....	136
134.....	60	268.....	48	377.....	116	518.....	128	759.....	146
135.....	17	269.....	60	380.....	144	520.....	122	762.....	154
136.....	4	271.....	162	395.....	192	524.....	126	769.....	155
137.....	84	272.....	162	401.....	193	526.....	119	770.....	155
138.....	46	273.....	45	403.....	59	527.....	124	775.....	140
139.....	13	276.....	46	404.....	200	528.....	123	776.....	187
140.....	24	277.....	45	406.....	193	530.....	132	777.....	175
142.....	118	278.....	45	408.....	193	531.....	94	786.....	95
144.....	102	280.....	87	410.....	193 & 194	532.....	94	797.....	154
148.....	190	281.....	45	412.....	59	533.....	146	805.....	111
149.....	157	283.....	45	415.....	193 & 194	534.....	61	806.....	72, 73 & 77
150.....	102	284.....	45	420.....	102	535.....	61	807.....	72, 73 & 77
152.....	157	285.....	118	424.....	95	537.....	130	808.....	161
153.....	102	290.....	46	427.....	143	538.....	61	809.....	72, 73 & 77
155.....	154	294.....	60	428.....	143	539.....	119	810.....	72, 73 & 77
158.....	103	295.....	45	429.....	137	540.....	120	811.....	72 & 73
		296.....	45	432.....	97	541.....	120	816.....	72 & 73
				433.....	61 & 62	542.....	120	817.....	72 & 73

## NUMERICAL INDEX

<b>FIG. No.</b>	<b>PAGE No.</b>	<b>FIG. No.</b>	<b>PAGE No.</b>	<b>FIG. No.</b>	<b>PAGE No.</b>	<b>FIG. No.</b>	<b>PAGE No.</b>
820	72 & 73	926	185	1044	85	1151	56
825	112	927	182	1045	22 to 25, 41 to 43	1152	56
826	130	928	181	1046	23 to 25, 41 to 43	1153	56
828	149	929	179	1047	23 to 25, 41 to 43	1154	56
829	149	930	181	1048	22, 23, 25 & 44	1155	151
830	149	931	172	1049	22, 25,	1156	84
831	148	932	172	1049	26 & 43	1158	20
832	149	934	189	1050	141	1161	4
833	149	935	189	1051	185	1164	53
834	111	937	189	1052	144	1165	53
835	111	938	184	1053	165	1166	53
836	72 & 73	939	14	1054	165	1167	53
837	72,73 & 77	941	159	1056	184	1168	53
839	72,73 & 77	942	162	1057	136	1169	52
841	186	944	189	1059	25, 41 & 43	1170	52
844	72,73 & 77	945	14	1060	25, 41 to 43	1172	52
845	72,73 & 77	946	14	1064	85	1173	52
846	72,73 & 77	947	165	1065	167	1174	52
847	77	948	183	1068	179	1177	167
848	77	949	160	1071	173	1178	17
851	63 & 71	951	159	1072	173	1179	152
852	63 & 71	952	159	1074	85	1180	152
859	77	953	180	1081	173	1181	18
860	72,73 & 77	954	188	1082	173	1183	19
866	78	955	9	1084	85	1184	18
869	191	956	166	1087	86	1185	151
870	99	957	163	1089	172	1186	151
872	72 & 77	958	188	1090	86	1187	151
873	72 & 77	959	166	1091	171 & 172	1188	131
874	72	960	182	1092	171 & 172	1189	95
875	72	962	178 to 182	1093	171 & 185	1190	95
876	72	963	12	1099	199	1191	95
878	72	964	17	1100	199	1192	30
879	72	965	14	1101	183	1194	164
880	72 & 77	966	189	1102	183	1196	19
883	66 & 67	967	155	1103	186	1197	19
884	68 & 69	968	179	1104	200	1198	164
885	70 & 71	969	63 & 71	1105	49 to 53	1199	166
887	65	972	4	1106	190	1201	7
889	74	975	190	1107	199	1205	199
890	74	976	178 to 181	1108	156	1209	27 & 43
891	74	977	174 & 175	1109	46	1210	131
893	78	978	178	1110	188	1211	6
894	78	980	174	1111	58	1212	6
895	78	984	178 to 181	1112	156	1213	161
896	191	987	161	1113	156	1214	161
897	78	988	161	1116	152	1215	201
898	191	991	178	1117	152	1216	168
899	78	992	174	1118	201	1217	168
901	191	994	191	1119	49	1218	5
902	74	995	178 to 181	1123	20 & 44	1220	187
903	139	996	191	1124	20 & 44	1221	187
904	5	997	191	1125	21 & 43	1222	140
905	74	998	164	1127	49	1223	135
907	191	999	161	1128	49	1226	146
908	74	1002	158	1129	49 & 58	1227	150
910	74	1004	158	1130	49	1230	133
911	78	1015	141	1133	52	1231	140
912	178 to 180	1016	188	1134	28	1232	186
913	178 & 182	1017	145	1137	28	1234	138
915	13	1021	184	1143	58	1235	138
918	180	1028	181	1144	18	1236	19
919	180	1029	179	1146	84	1238	100
920	178 to 180	1030	181	1150	56	1239	178
921	175	1031	172			1240	178
922	175	1032	172			1242	145
924	163	1040	87			1243	147
925	185	1043	141			1244	165
						1246	148
						1247	130
						1248	130
						1249	192
						1252	132
						1253	88
						1254	86
						1256	147
						1258	88
						1260	88
						1261	147 & 166
						1262	150
						1264	9
						1267	150
						1269	127
						1270	124
						1271	100
						1273	20
						1274	20
						1277	143
						1279	180
						1280	180
						1281	18
						1283	19
						1284	18
						1287	166
						1289	148
						1290	153
						1291	153
						1292	153
						1293	160
						1296	6
						1299	148
						1301	30
						1302	142
						1303	83
						1304	143
						1305	134
						1306	134
						1309	148
						1310	4
						1311	27
						1312	99
						1313	125
						1314	195
						1316	134
						1318	121
						1319	121
						1320	195
						1322	142
						1323	89
						1324	125
						1325	141
						1326	134
						1327	143
						1330	27
						1331	17
						1332	15
						1336	140
						1340	29
						1341	29
						1346	140
						1363	54
						1364	51
						1365	51
						1366	51
						1367	51
						1368	51

## NUMERICAL INDEX

<b>FIG. No.</b>	<b>PAGE No.</b>	<b>FIG. No.</b>	<b>PAGE No.</b>	<b>FIG. No.</b>	<b>PAGE No.</b>	<b>FIG. No.</b>	<b>PAGE No.</b>	<b>FIG. No.</b>	<b>PAGE No.</b>
1369	50	1460	42	1640	24 & 25	1936	78	9551	82
1370	50	1461	22	1641	23 & 25	8501	92	9560	82
1372	50	1465	42	1650	22 & 25	8502	92	9563	82
1373	50	1601	13	1651	22, 25 & 26	8503	92	9565	82
1374	50	1602	13	1655	22 & 25	8504	92	9566	82
1399	125	1604	29	1660	24 & 25	8603	92	9568	82
1400	41	1611	27	1714	196	9304	79 & 80	9581	82
1401	24	1612	5	1798	196	9501	82	9582	82
1413	125	1613	125	1901	76 & 77	9504	82	9601	93
1421	6	1614	5	1902	76 & 77	9506	82	9602	93
1422	6	1621	23 & 25	1921	75 & 77	9508	82	9603	93
1430	24 & 25	1630	24 & 25	1922	75 & 77	9510	82	9604	93
1431	23 & 25	1631	24 & 25	1925	75 & 77	9511	82	9703	93
1440	42	1632	23 & 25	1930	77	9512	82	9854	79 & 81
1445	42	1633	24 to 26	1931	77	9514	82		
1450	42	1634	28	1932	78	9521	82		
1455	42	1637	28	1933	78	9530	82		

## ALPHABETICAL INDEX

<b>A</b>	<b>PAGE</b>
Adapter - Pipe to Hose	112
Adjusters - Hatch	154
Windshield	152 & 153
All-Round Lights	18 to 30, 34, 36 40 to 42 & 49 to 59
Anchor Chocks	139
Anchor Lights	18 to 36, 41, 42, & 59 to 59
Assemblies, Control	63 to 65, 68, 70, 75, 76 & 80 to 86
Axe Brackets	145
<b>B</b>	<b>PAGE</b>
Bass Boat Lights	5
Bells -Fog	102 & 103
Berth Lights	89
Bi-Color Lights	2 to 6 & 32 to 35
Bits	137
Boarding Steps	141
Bolts - Barrel	165
Cupboard	183
Book, Log	98
Bow - Lights	2 to 6 & 31 to 39
Anchor Lights	18 to 21
Combination Lights	2 to 6, 32 & 33
Eyes	138
Brackets - Axe	145
Table	190
Breakdown Lights	49 to 59
Bulbs, Electric	47, 60, 72, 73 & 97
Butt Hinges	158 to 164
Buttons - Door	168
Horn Push	94
<b>C</b>	<b>PAGE</b>
Cabin Door Hooks	166
Cabinet Hinges	159 to 163

<b>C - CONTINUED</b>	<b>PAGE</b>
Cable - Outlet	95
Straps	96
Caps, Gas Tank	114 to 119
Catches, Door	168, 183 & 185
Certification of Lights	VIII & 48
Chain - Deck Pipe	136
Portlight	98
Chocks	135
Chocks, Anchor	139
Clam Shell Ventilators	99
Clamps - Hatch Hold - Down	156
Spring	144
Rope	146
Cleats	131 to 134 & 137
Clips - Line Support	96
Trolling	197
Coat & Hat Hooks	190
Cockpit Scupper	116 to 118
Combination - Bow & Anchor Lights	18 to 21
Side Lights	8 to 13, 31 to 40 & 49 to 57
Connections - Electric	95
Thru Hull	113 to 118
Watertight, Deck	95
Connectors, Electric	95
Connectors, Garden Hose	119
Continuous Hinge	157
Control Assemblies,	63 to 65, 68, 70, 75, 76 & 80 to 86
Convertible Boat Top Fittings	192
Courtesy Lights	86 & 87
Cowl Ventilators	99
Cupboard - Bolts	183
Catches	168 & 183
Turns	183
Curtain Fasteners	191

## ALPHABETICAL INDEX

<b>D</b>	<b>PAGE</b>
Deck -	
Connection, Watertight .....	95
Lights .....	16 & 88
Pipes, Rope & Chain .....	136
Plate Keys .....	130
Plates .....	119, 123 to 126
Dock Line Springs .....	146
Dome Lights .....	88 & 89
Door -	
Buttons .....	168
Catches .....	168, 183 & 185
Fasteners .....	155 & 156
Hinges .....	157 to 162
Holders .....	167 & 168
Hooks .....	166
Stops .....	167
Drain Plugs .....	109 & 110
Drawer -	
Knobs .....	185
Pulls .....	185 to 188
Dredging Light .....	58
Dorade Ventilator .....	99

<b>E</b>	<b>PAGE</b>
Elbow Catches .....	184
Electric -	
Bulbs .....	47, 60, 72, 73 & 97
Cabin Fixtures .....	83 to 89
Connections .....	95
Lamps .....	83 to 89
Sockets .....	43, 44, 46, 60, 72, 77 & 78
Switches .....	91 to 94
European Representative .....	VI
Eyes -	
Bow .....	138
Flange .....	138
Lashing .....	137 & 138
Lifting .....	137
Transom .....	138

<b>F</b>	<b>PAGE</b>
Fasteners -	
Curtain .....	191
Door .....	155 & 156
Hatch .....	155 & 156
Table Leg .....	190
Fender -	
Hooks .....	148
Locks .....	148
Filler, Tank .....	120 to 127
Filters, Water .....	106 & 107
Fishing Rod Holders .....	198 to 202
Fittings -	
For Boat Top .....	191 & 192
For Rails .....	144
Waste .....	126 & 127
Fixtures, Light -	
Bulkhead, Electric .....	83 to 89
Electric Cabin .....	83 to 89
Vapor Proof .....	89
Flag Pole Sockets .....	142 & 143
Flag Staffs .....	142 & 143
Flange Eyes .....	137
Flush Pro .....	105
Flush -	
Hatch Lifting Handles .....	187
Hatch Lifting Rings .....	185 & 186
Locks & Latches .....	169 to 182

<b>F - CONTINUED</b>	<b>PAGE</b>
Pulls .....	171 to 188
Ring Catch .....	185
Fog Horn .....	98
Fuel Tank Filler .....	120 to 127
Fuse -	
Holder .....	95
Panels .....	94

<b>G</b>	<b>PAGE</b>
Gas -	
Tank Caps .....	120 to 127
Tank Filler .....	120 to 127
Tank Vents .....	128 & 129
Globes .....	45, 60, 83 to 85
Grab Rail Posts .....	144
Guides, Tiller Rope .....	147
Guides, Pole Line .....	197

<b>H</b>	<b>PAGE</b>
Halyard Mount Lights .....	34 to 35
Handles -	
Flush Lifting .....	174 & 186
Sliding Window .....	188
Utility .....	137
Hasps .....	164
Hatch -	
Adjusters .....	154
Dog .....	174
Fasteners .....	155, 156 & 174
Hinges .....	157 to 163
Hold-Down Clamps .....	156
Lifting Handles .....	174 & 186
Lifting Rings .....	185 to 186
Trim .....	157
Support Braces .....	154
Hawse Hole Plate .....	137
Heights, Vertical Light .....	38 & 39
Hinges -	
Butt .....	158 to 160
Cabinet .....	159 to 163
Continuous .....	157
Cuddy Door .....	158 to 163
Hatch .....	158 to 163
Hatch Support .....	154
Non-Mortised .....	163
Piano .....	157
Pull Apart .....	157
Semi-Concealed .....	162
Shortside .....	161 to 163
Strap .....	163
"T" .....	163
Holdings -	
Boat Hook .....	144
Door .....	166
Fishing Pole .....	198 to 202
Ring Buoy .....	145
Outrigger Pole .....	193 to 195
Hooks -	
Cabin Door .....	166
Coat Hook .....	190
Fender .....	148
Lashing .....	190
Snap .....	148
Utility .....	190
Wardrobe .....	190
Horn, Fog .....	98
Horns for Rowlocks .....	149 & 150
Hull Connections .....	113 to 118

## ALPHABETICAL INDEX

### I PAGE

Information -	
Certification of Navigation Lights .....	VIII & 48
Electrical Standards .....	90
Light, Vertical Heights .....	38 & 39
Lock Bevels.....	177
Lock & Latch .....	170 to 182
Representatives.....	VI
Searchlight Bulb Data .....	72, 73, 77 & 82
Sales Policy & Terms.....	II
Warranty.....	II
Inlet -	
Fittings for Fresh Water .....	119
Strainer.....	108

### K PAGE

Keys, Deck Plate .....	130
Knobs, Drawer .....	18

### L PAGE

Lamps -	
Cabin.....	83 to 89
Wall.....	83 to 89
Lashing Eyes.....	137 & 138
Lashing Hooks .....	190
Latches -	
Doors .....	170 to 182
Flush .....	170 to 178
Mortise Latch Sets.....	176 & 182
Rim Latch Sets .....	179 to 182
Leathers, Oar.....	151
L.E.D. Lights .....	2, 8, 29, 31, 84 & 85
Lenses.....	45 & 60
Lifting Eyes .....	138
Light Chart, Vertical Heights .....	38 & 39
Lights -	
All-Round.....	18 to 30, 34, 36
.....	40 to 42 & 49 to 59
Anchor .....	18 to 36, 41,
.....	42, & 59 to 59
Bass Boat.....	5
Berth.....	89
Bi-Color .....	2 to 6 & 32 to 35
Breakdown.....	49 to 59
Combination.....	6, 7, 18 to 20 & 49 to 59
Courtesy .....	84 & 85
Deck .....	16 & 87
Dredging.....	58
Dome.....	88 & 89
For Windshield Mounting .....	18, 20 & 28
L.E.D .....	2, 8, 29, 31, 84 & 85
Masthead.....	2, 7, 16 to 21,
.....	29 to 42, 49 to 59
Meal & Absent.....	36
Not Under-Command.....	49 to 59
Pole.....	5, 6, 18 to 30
Range .....	49 to 59
Searchlights .....	61 to 82
Side.....	2, 8 to 13, 31 to 39 & 49 to 57
Signal .....	31 to 40 & 49 to 59
Spreader .....	87
Stern.....	2, 14, 15, 31 to 37, 49 to 59
Towing.....	30 to 33 & 42 to 50
Tri-Color .....	7
Utility .....	84 to 86
Vapor-Proof.....	86
Line Support Clips .....	96
Locks -	
Doors .....	169 to 183

### L - CONTINUED PAGE

Fender.....	148
Flush .....	169 to 179
Mortise.....	176 & 182
Rim .....	179 & 183
Window .....	187
Lock & Latch Selection Chart .....	175
Log Book.....	98
Locker Ventilators .....	100
Louver Ventilators.....	101

### M PAGE

Masthead.....	2, 7, 16 to 21,
.....	29 to 42, 49 to 59
Meal & Absent .....	36
Mooring Bitts.....	137

### N PAGE

Navigation Lights -	
For Vessels:	
Under 20 Meters (65.6 Ft.) in Length .....	1 to 47
Over 20 Meters (65.6 Ft.) in Length .....	48 to 60

### O PAGE

Oar -	
Leather & Buttons .....	151
Locks.....	149 to 151
Outlets -	
Cable.....	95
Water.....	119
Outrigger -	
Holders.....	193 to 195
Kit.....	197
Pole Line Guides.....	197
Poles .....	196
Spreaders.....	196
Trolling Pins .....	197

### P PAGE

Panels -	
Fuse .....	94
Switch.....	94
Piano Hinge .....	157
Pin, Trolling.....	197
Pipes, Rope Deck.....	136
Plates -	
Deck .....	119, 123 & 126
Hawse Hole.....	137
Step.....	141
Plugs, Drain.....	109 & 110
Pole Holders -	
Replacement Bases .....	43 & 44
Replacement Poles .....	41 & 42
Vertical Height Chart .....	38 & 39
Pole Lights.....	5, 6, 18 to 30
Pole Sockets, Flag .....	142 & 143
Poles -	
Flag.....	142 & 143
Outrigger .....	196
Posts -	
Grab Rail.....	144
Stanchion .....	144
Pulleys .....	147
Pulls -	
Drawer .....	184 to 186
Flush .....	184 to 186
Pump Strainers.....	106

## ALPHABETICAL INDEX

<b>R</b>	<b>PAGE</b>
Rail Fittings.....	144
Range Lights.....	49 to 59
Representatives.....	VI
Rigging Tube.....	139
Rim Locks.....	170 to 183
Rim Latches.....	178 to 183
Ring -	
Buoy Holders.....	145
Catches, Flush.....	185
Pulls.....	185 to 186
Rings, Hatch Lifting.....	185 to 186
Roller Tip Line Guide.....	197
Rope -	
Clamps.....	146
Guides.....	147
Pulleys.....	147
Rope Tighteners.....	146
Rowlocks.....	149 to 151

<b>S</b>	<b>PAGE</b>
Safety Cable.....	130
Scuppers -	
Cockpit.....	116 to 118
Thru-Hull.....	116 to 118
Valve Assembly.....	111
Seacocks.....	111
Searchlights -	
Bulbs.....	72, 73 & 97
Control Assemblies.....	63 to 65, 68, 70, 75, 76 & 80 to 86
Spare Parts.....	61 to 82
Searchlights.....	61 to 82
Shield, for Pole or Mast Lights.....	30
Side Lights.....	2, 8 to 13, 31 to 39 & 49 to 57
Signal Lights, Portable or Fixed.....	31 to 40 & 49 to 59
Snap Hooks.....	148
Sockets -	
Boat Cover.....	192
Sockets.....	43 to 46, 60, 73, 77 & 78
Fishing Rod.....	198 to 202
Flag Pole.....	142 & 143
Rowlock.....	149 & 151
Searchlight.....	73, 77 & 78
Spreaders for Outrigger Poles.....	196
Spreader Lights.....	87
Spotlights.....	61 to 82
Spring Clamps.....	144
Springs for Dock Line.....	146
Spring, Tiller Rope.....	146
Staffs, Flag.....	142 & 143
Steps -	
Boarding.....	141
Folding.....	141
Step Plates.....	141
Stern -	
Lights.....	2, 14, 15, 31 to 37, 49 to 59
Pole Lights.....	5, 6, 18 to 30
Stops -	
Door.....	167
Window.....	189
Strainers -	
Thru-Hull.....	108 & 109
Inlet.....	106 to 108
Pump.....	109
Water.....	106 & 108
Strap Hinges.....	163
Strap Cable.....	96
Switch Panels.....	94

<b>S - CONTINUED</b>	<b>PAGE</b>
Switches -	
Battery.....	91 to 93
Electric.....	91 to 94
Master.....	92
Panel.....	94
Swivel -	
Eye Pulleys.....	147
Eye Snaps.....	148

<b>T</b>	<b>PAGE</b>
"T" Hinges.....	163
Table Brackets.....	190
Table Leg Fasteners.....	189
Thru-Hull Connections.....	113 to 116
Towing Lights.....	30 to 33 & 42 to 50
Transom -	
Eyes.....	138
Stern Lights.....	2, 14, 15, 31 to 37, 49 to 59
Ventilators.....	99 to 101
Trim Hatch.....	157
Trolling Pin.....	197
Tube, Rigging.....	139
Tri-Color Lights.....	7
Turns Cupboard.....	183

<b>U</b>	<b>PAGE</b>
Universal Replacement Pole Light.....	41 & 42
Utility Hooks.....	190
Utility Lights.....	84 to 86

<b>V</b>	<b>PAGE</b>
Vapor Proof Fixtures.....	96
Ventilator -	
Cowl.....	99
Dorade.....	99
Gas Tank.....	128 & 129
Locker.....	100
Louver.....	101
Clam Shell Type.....	99
Transom.....	100

<b>W</b>	<b>PAGE</b>
Wardrobe Hooks.....	190
Warranty Information.....	II
Waste Fitting.....	126 & 127
Water Strainers.....	106 to 108
Water Strainer Graphs.....	107
Whistle.....	98
Window -	
Anti-Rattler.....	189
Handle, Sliding.....	188
Lock.....	189
Stop.....	189
Windshield -	
Adjusters.....	152 & 153
Keeper Plate.....	155
Pole Lights for.....	18, 20 & 28
Wiper.....	146